

Detail A

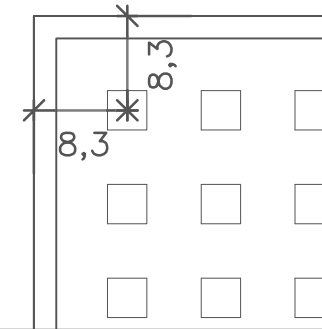

Detail B

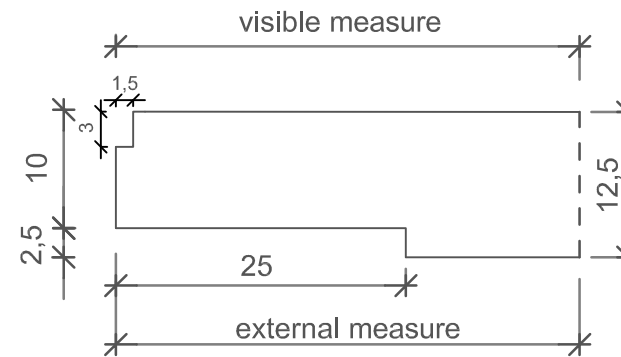

Detail C

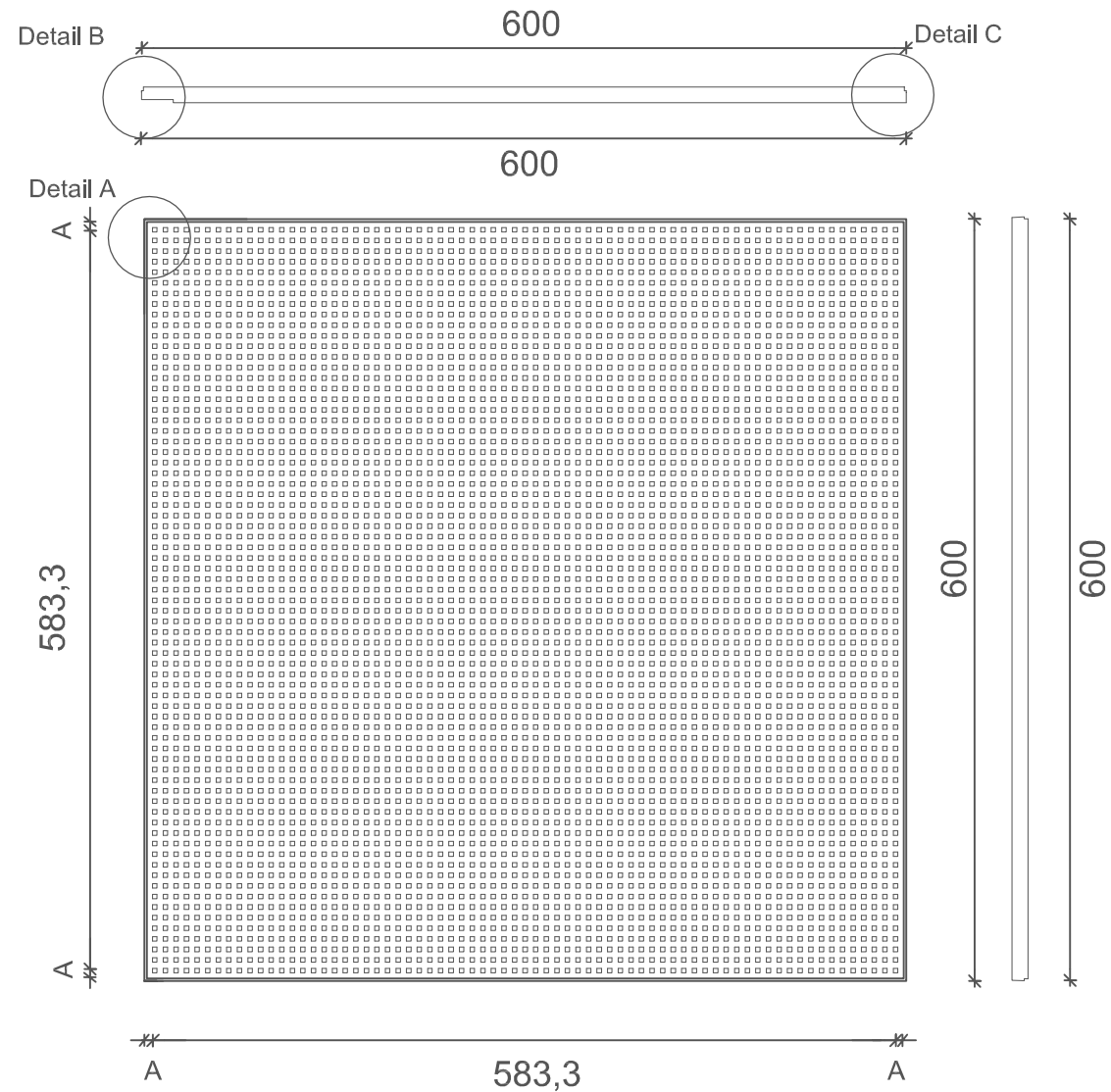
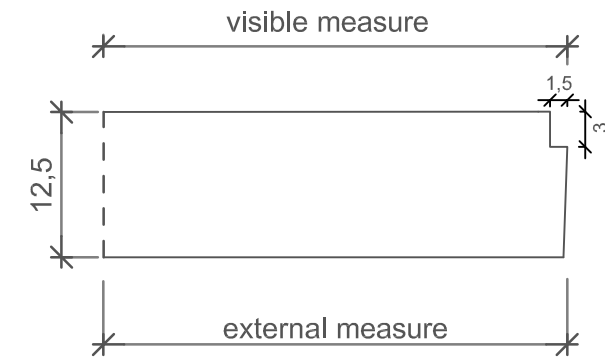

Perforation pattern: Unity 3 (3,5 x 3,5mm holes cc 8,33mm)
 Perforation percentage: 17,2 %
 Edge type: Contur D+
 Grid: S24
 Module: 600 x 600 x 12,5mm
 Visible measure (primary): 600 x 600mm
 External measure (secondary): 600 x 600mm
 A measure: 8,3mm
 Perforation picture: 583,3 x 583,3mm (71 x 71 holes)

Project: Contur D+, S24, Module 600x600, Unity 3	MDM no.: 471331
Subject:	Scale:
	Date: 2018-05-02
	Rev.:
	Sign.: NPJ
	Project no.:
Knauf Danoline A/S Kløvermarksvej 6, DK-9500 Hobro T: +45 9657 3000 F: +45 9657 3001 www.knaufdanoline.com - info@knaufdanoline.com	File:

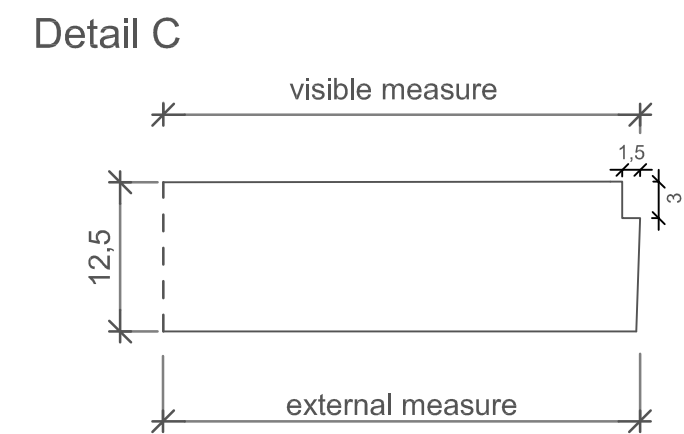
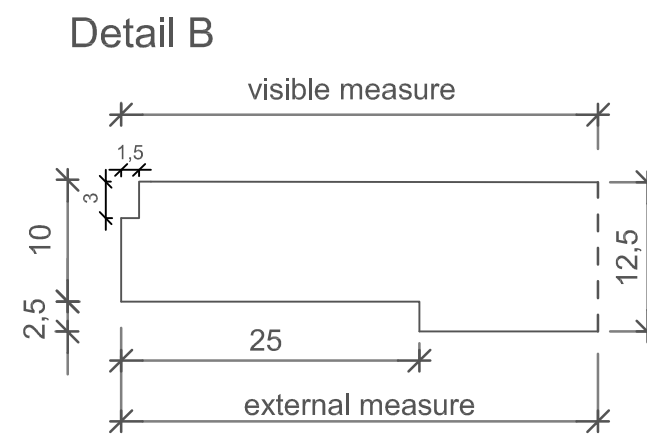
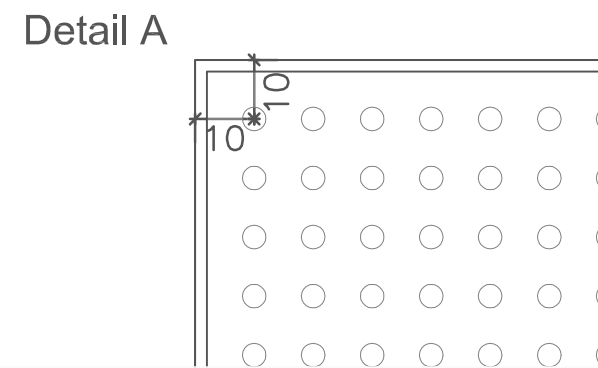
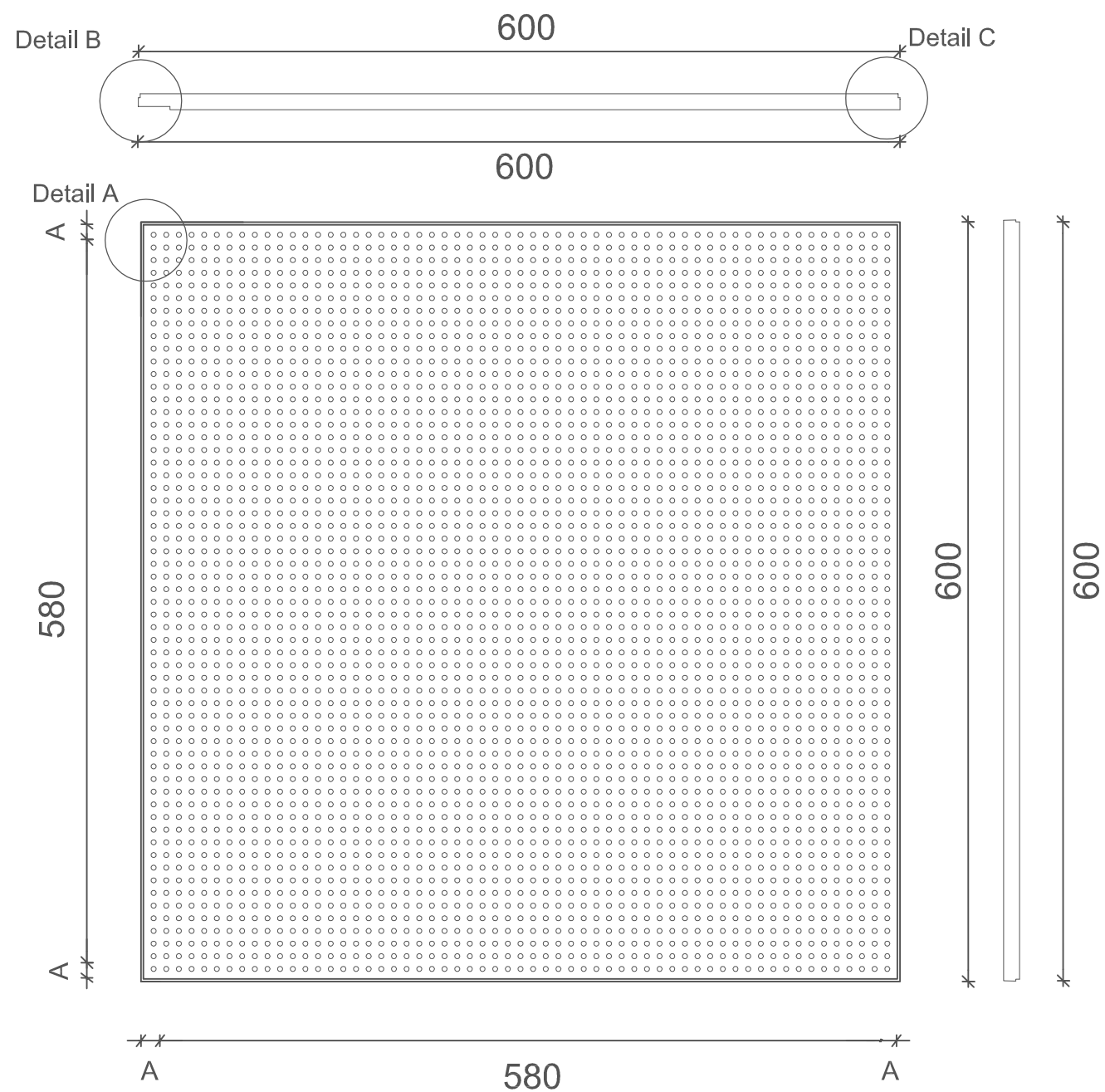

Perforation pattern: Unity 4 (Ø4mm hole cc 10mm)
 Perforation procentage: 12,2 %
 Edge type: Contur D+
 Grid: S24
 Module: 600 x 600 x 12,5mm
 Visible measure (primary): 600 x 600mm
 External measure (secondary): 600 x 600mm
 A measure: 10mm
 Perforation picture: 580 x 580mm (59 x 59 holes)

Project: Contur D+, S24, Module 600x600, Unity 4	MDM no.: 532683
Subject:	Scale:
	Date: 2018-05-02
	Rev.:
	Sign.: NPJ
	Project no.:
Knauf Danoline A/S Kløvermarksvej 6, DK-9500 Hobro T: +45 9657 3000 F: +45 9657 3001 www.knaufdanoline.com - info@knaufdanoline.com	File:

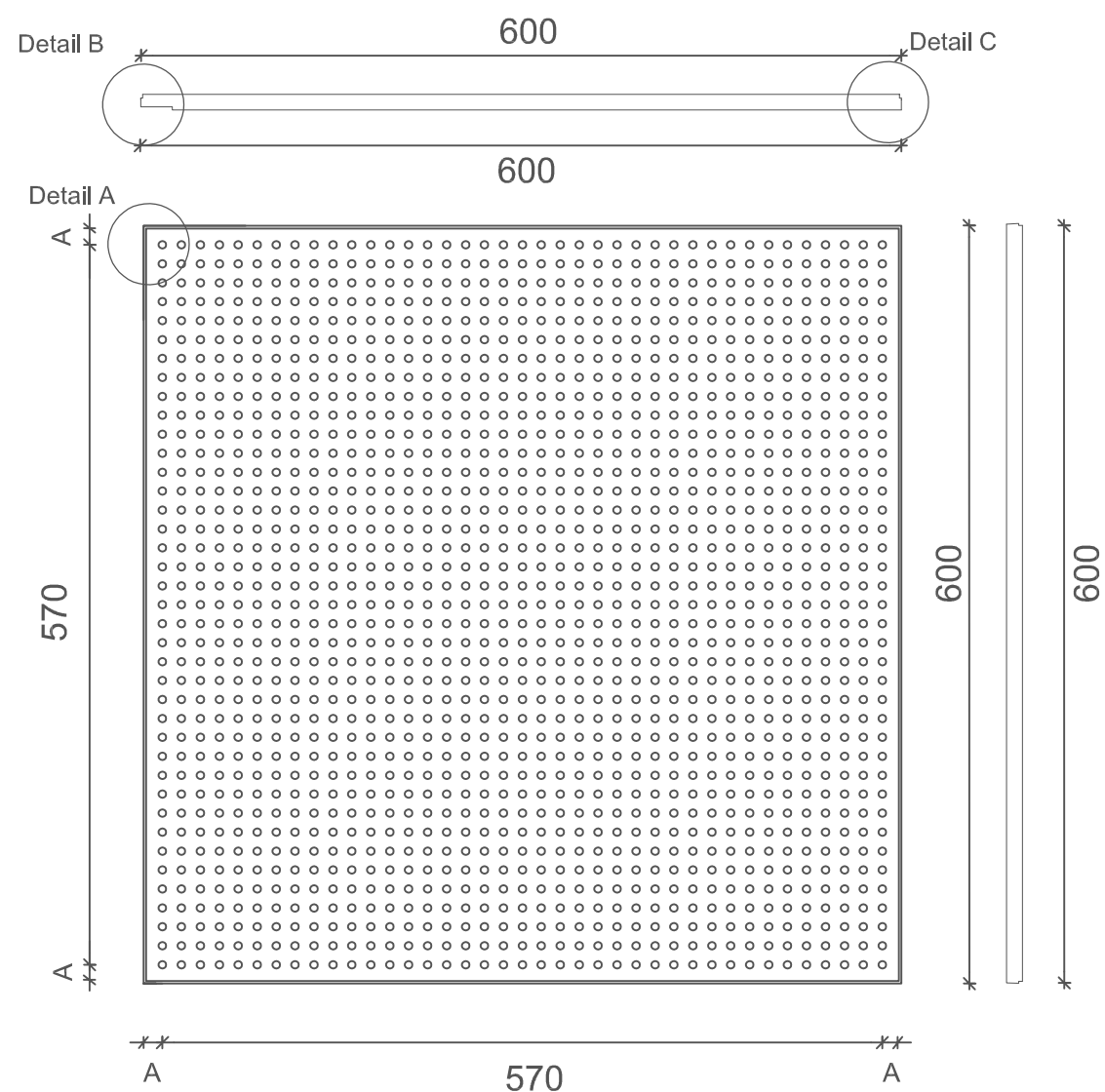

Detail A

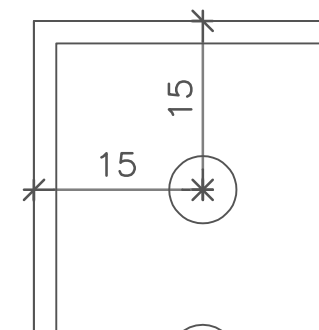

Detail B

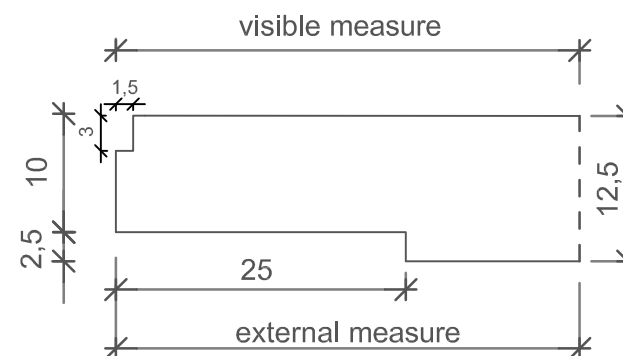

Detail C

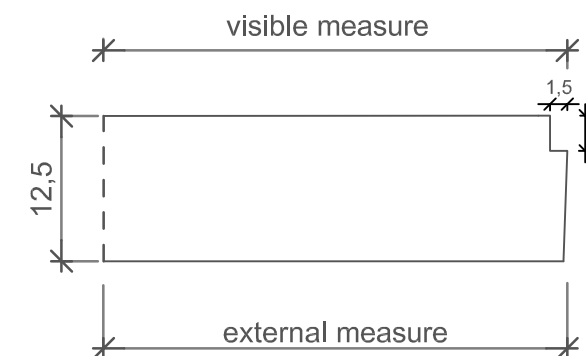

Perforation pattern: Unity 6 (6mm round holes cc 15mm)
 Perforation percentage: 11,9 %
 Edge type: Contur D+
 Grid: S24
 Module: 600 x 600 x 12,5mm
 Visible measure (primary): 600 x 600mm
 External measure (secondary): 600 x 600mm
 A measure: 15mm
 Perforation picture: 570 x 570mm (39 x 39 holes)

Project: Contur D+, S24, Module 600x600, Unity 6	MDM no.: 706279
Subject: White acoustic fleece backing	Scale:
	Date: 2020-10-02
	Rev.:
	Sign.: FKS
	Project no.:
Knauf Danoline A/S Kløvermarksvej 6, DK-9500 Hobro T: +45 9657 3000 F: +45 9657 3001 www.knaufdanoline.com - info@knaufdanoline.com	File:

Detail A

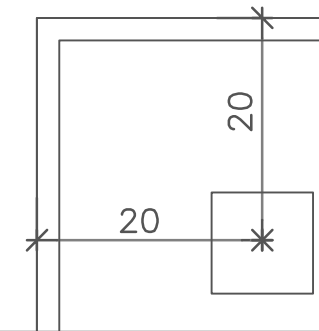

Detail B

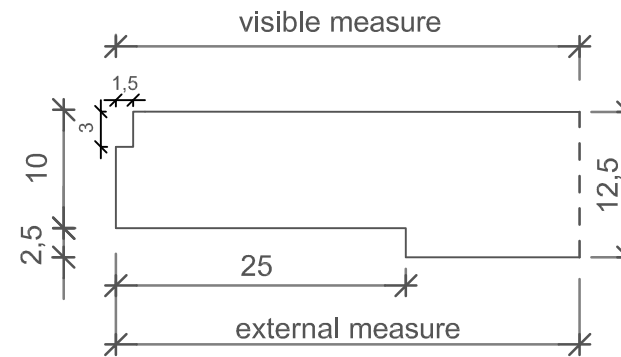

Detail C

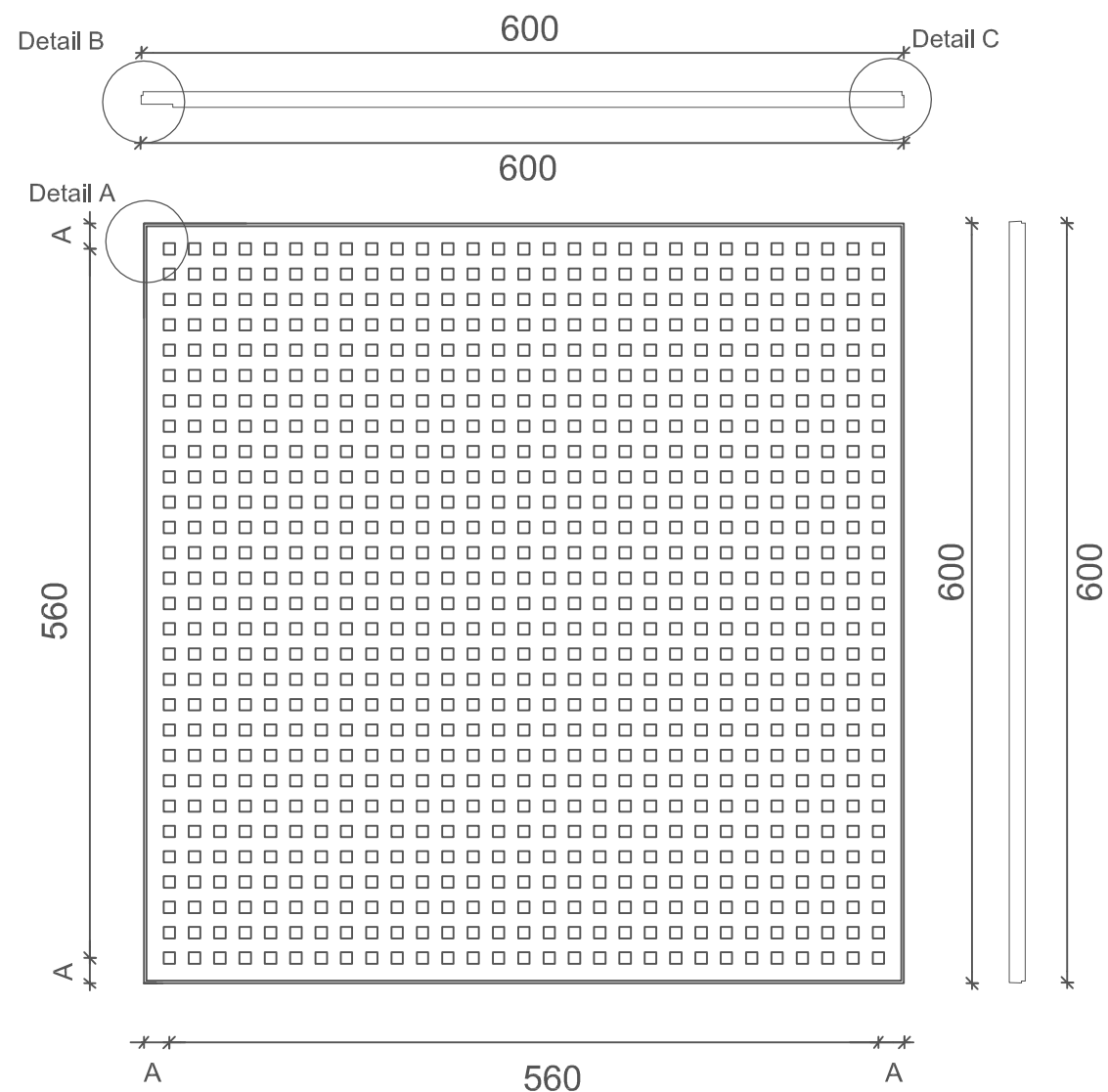
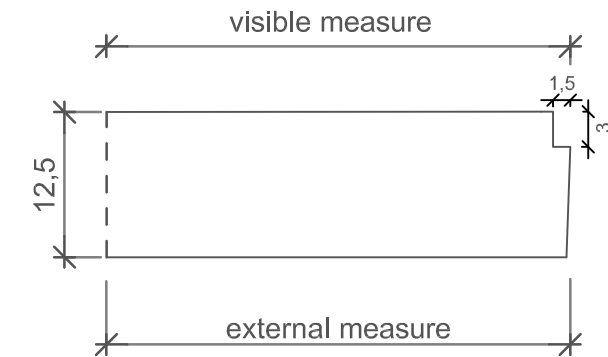

Perforation pattern: Unity 9 (9 x 9mm holes cc 20mm)
 Perforation percentage: 18,9 %
 Edge type: Contur D+
 Grid: S24
 Module: 600 x 600 x 12,5mm
 Visible measure (primary): 600 x 600mm
 External measure (secondary): 600 x 600mm
 A measure: 20mm
 Perforation picture: 560 x 560mm (29 x 29 holes)

Project: Contur D+, S24, Module 600x600, Unity 9	MDM no.: 661379
Subject:	Scale:
	Date: 2019-04-04
	Rev.:
	Sign.: FKS
	Project no.:
	File:
<small>Knauf Danoline A/S Kløvermarksvej 6, DK-9500 Hobro T: +45 9657 3000 F: +45 9657 3001 www.knaufdanoline.com - info@knaufdanoline.com</small>	

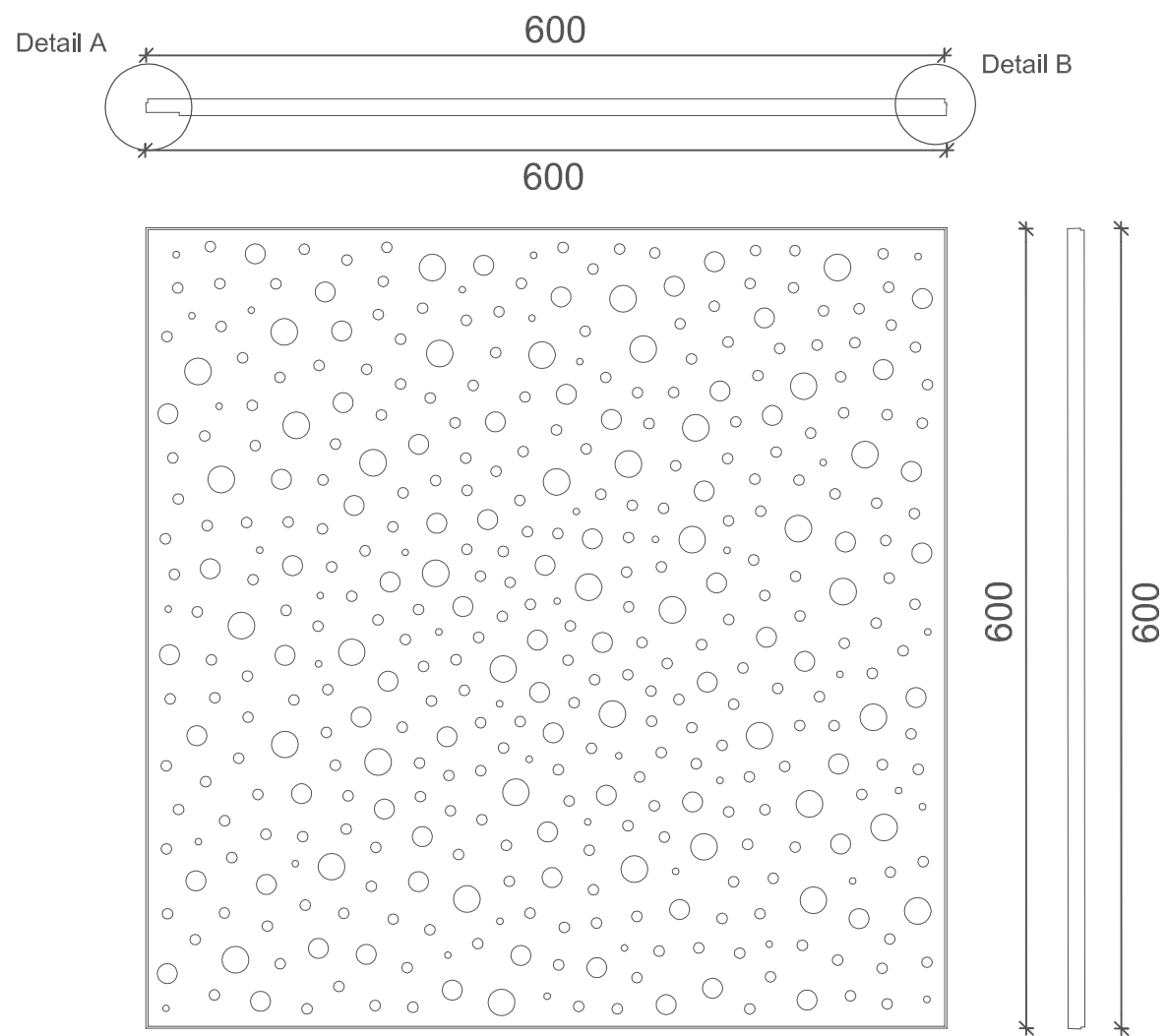

Detail A

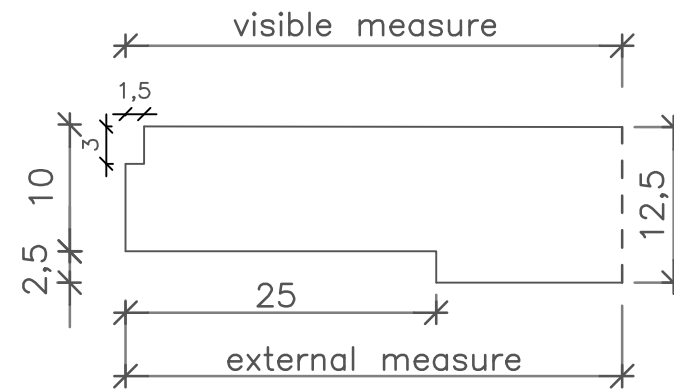

Detail B

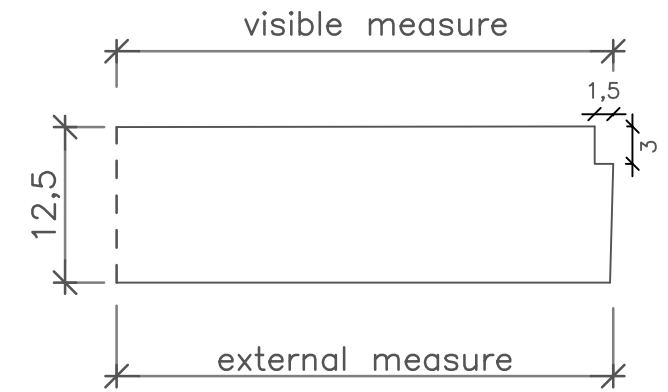

Perforation pattern:	Unity 8115I20
Perforation percentage:	10,8 %
Edge type:	Contur D+
Grid:	S24
Module:	600 x 600 x 12,5mm
Visible measure (primary):	600 x 600mm
External measure (secondary):	600 x 600mm
Perforation picture:	579,6 x 579,6mm

Project: Contur D+, S24, Module 600x600, Unity 8115I20	MDM no.: 471325
Subject:	Scale:
	Date: 2018-04-18
	Rev.:
	Sign.: NPJ
	Project no.:
Knauf Danoline A/S Kløvermarksvej 6, DK-9500 Hobro T: +45 9657 3000 F: +45 9657 3001 www.knaufdanoline.com - info@knaufdanoline.com	File: