

ACOUSTIC CEILINGS AND WALLS IN GYPSUM



KNAUF UNITY

EXPERIENCE THE UNITY OF ACOUSTICS AND AESTHETICS

The Unity series seeks to return the ceiling surface to its calm, undisturbed state. And still maintain the functionality of a T-grid ceiling. It's a fusion of two worlds. Developed for architects. And it's your opportunity to explore new architectural possibilities with perfect acoustics.

The uniqueness of Unity series lies in its perforation designs which extend to the edge of the tile. Find the Unity perforations under Contur, Plaza and Belgravia and learn more.





WELCOME TO 50 YEARS OF QUALITY & EXPERIENCE

YOUR ROUTE TO INDOOR COMFORT

Headquartered in Denmark Knauf Danoline develops and manufactures acoustic ceiling and wall materials based on high grade glass fiber reinforced gypsum. With over 50 years' experience in the construction industry, we have expertise, guidance and technical know how to meet your requirements.

WHEN CHOOSING KNAUF DANOLINE, YOU BENEFIT FROM:

- Unmatched expertise gained over five decades of experience
- Sustainable and environmentally friendly materials
- Excellent indoor comfort for building occupants
- Extensive range of technical and design solutions for both ceilings and walls

OUR HIGH QUALITY PRODUCTS INCLUDES

- Demountable T-grid ceilings – an expansive selection of acoustic ceiling tiles with different expressions, design opportunities and acoustic profiles
- Self-supporting ceilings – special purpose acoustic ceilings for corridors and narrow rooms
- Non-demountable ceilings – a variety of acoustic panels for screw-fixing with different design expressions, installation methods and acoustic profiles
- Wall linings – a wide choice of acoustic panels for wall mounting, including the option for complete integration with existing wall construction
- Special purpose – hygienic ceilings, wall panels for cinemas, impact resistant linings for sports halls
- Curved and mitred elements – design elements for organic shapes or well defined edges

Thanks to our unmatched industry expertise and long experience, we have the knowledge and technical understanding to tailor solutions for every application. Contact us to discuss how we can add value to your next project.

Based in Denmark, Knauf Danoline is part of the international Knauf Group - a worldwide provider of construction materials. With a global network of offices and partners, we operate in more than 40 countries. For your local Knauf Danoline representative, please go to knaufdanoline.com.

Knauf Danoline products are tested for indoor climate properties (DIM). They have low particle emission and an indoor value of <10 days.

Knauf Danoline is ISO 9001 and ISO 14001 accredited.





KNAUF DANOLINE ACOUSTIC GYPSUM CEILINGS

ACOUSTIC CEILING TILES

THE INDIVIDUAL BOARDS ARE AVAILABLE WITH MORE PERFORATIONS AND IN REGULA – SEE UNDER THE INDIVIDUAL PRODUCTS



VISONA TANGENT
EDGE E/B

CONTUR U3
EDGE D+

CONTUR MICRO
EDGE D

BELGRAVIA U8 | 15 | 20
EDGE E+

BELGRAVIA GLOBE
EDGE E

MARKANT QUADRIL
EDGE E



PLAZA U4
EDGE A+

PLAZA GLOBE
EDGE A

DANOTILE
EDGE A

ACOUSTICAL PLANK CEILINGS

THE INDIVIDUAL BOARDS ARE AVAILABLE WITH MORE PERFORATIONS AND IN REGULA – SEE UNDER THE INDIVIDUAL PRODUCTS



CORRIDOR 400 MICRO
EDGE D

CORRIDOR SWING MICRO
EDGE E

ACOUSTICAL CEILING & WALL PANELS

THE INDIVIDUAL BOARDS ARE AVAILABLE WITH MORE PERFORATIONS – SEE UNDER THE INDIVIDUAL PRODUCTS



DESIGNPANEL MICRO
EDGE B1

TECTOPANEL TANGENT
EDGE B

CONTRAPANEL GLOBE
EDGE B

DANOPANEL MICRO
EDGE B (ONLY CEILING)

SOLOPANEL G6/18
EDGE SK, UFF OR MF

STRATOPANEL G8/15/20
EDGE SK OR UFF

ACOUSTIC WALL PANELS



KINOPANEL KINO
EDGE B

AMFIPANEL TANGENT
EDGE B

ADIT TANGENT
EDGE B

ACOUSTICAL SHAPES



MITEX

CURVEX

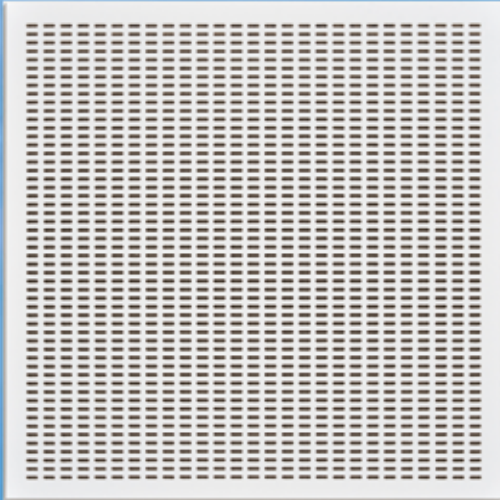

◀ CLEAN ACOUSTICS

Our entire range of acoustic products is available with an innovative air-purifying feature called Cleaneo.

Cleaneo technology helps decompose the harmful gasses that are emitted into the room by building materials, furniture and people.

CLENEO
TECHNOLOGY



The Knauf Danoline catalogue presents our entire product range with the most relevant data. For each product there are technical details, an installation guide and an accessories overview.

For download of drawings, photos and other digital data, please go to our website knaufdanoline.com.

WELCOME TO KNAUF DANOLINE CATALOGUE 2019

INTRODUCTION	3
--------------------	---

PRODUCT OVERVIEW	8
------------------------	---

ACOUSTIC CEILING TILES

Visona	10
Contur	18
Belgravia	26
Markant	34
Plaza	42
Danotile	50
Medley	58

ACOUSTICAL PLANK CEILINGS

Corridor 400	66
Corridor Swing	74
Corridor Planks	82

ACOUSTICAL CEILING PANELS

Designpanel	86
Tectopanel	100
Contrapanel	112
Danopanel	120
Solopanel	128
Stratopanel	138

ACOUSTIC WALL PANELS

Designpanel	148
Tectopanel	156
Contrapanel	164
Solopanel	170

Stratopanel	178
Kinopanel	186
Amfipanel	192
Adit	200

ACOUSTICAL SHAPES

Mitex	208
Curvex	212

PERFORATIONS

Unity 3	218
Unity 4	218
Unity 8 15 20	219
Unity 9	219
Micro	220
Quadril	220
Tangent	221
Globe	221
Solo	222
Strato	222
Kino	223













PROPERTIES

Acoustics	225
Air quality	226
Cleaning	227
Light reflection	228
Load-bearing capacity	229
Ambient conditions	229
Robustness	230
Environment	231
Fire safety	232
Hygiene	233
Colours	234
Warranty	235
Upkeep & maintenance	238

PRODUCT OVERVIEW

PRODUCT	EDGE	PERFORATION	SIZE (mm)	APPLICATION	PAGE
ACOUSTIC CEILING TILES					
VISONA Edge E/B		Tangent Regula	400 x 1200 x 12.5	Demountable, suspended ceiling in double T-grid with Drag ,n' Drop feature for flexible ceiling and lighting design	10
CONTUR Edge D		Globe Quadril Micro Regula	600 x 600 x 12.5 625 x 625 x 12.5	Demountable, suspended ceiling in concealed T-grid	18
CONTUR Edge D-Plus (D+)		Unity 3 Unity 4 Unity 8 15 20 Unity 9 Regula	600 x 600 x 12.5 625 x 625 x 12.5* * Not with Unity perforation	Demountable, suspended ceiling in concealed T-grid with perforation to the edge	18
BELGRAVIA Edge E		Globe Quadril Micro Tangent Regula	600 x 600 x 12.5 625 x 625 x 12.5	Demountable, suspended ceiling in recessed T-grid	26
BELGRAVIA Edge E-Plus (E+)		Unity 3 Unity 4 Unity 8 15 20 Unity 9 Regula	600 x 600 x 12,5 625 x 625 x 12.5* * Not with U4	Demountable, suspended ceiling in recessed T-grid with perforation to the edge	26
MARKANT Edge E		Globe Quadril Micro Regula	600 x 600 x 12.5 625 x 625 x 12.5	Demountable, suspended ceiling in recessed T-grid	34
PLAZA Edge A 9.5 mm		Globe Quadril Micro Regula	600 x 600 x 9.5 600 x 1200 x 9.5	Demountable, suspended ceiling in visible T-grid	42
PLAZA Edge A 12.5 mm		Tangent	600 x 600 x 12.5 625 x 625 x 12.5	Demountable, suspended ceiling in visible T-grid	42
PLAZA Edge A-Plus (A+)		Unity 3 Unity 4 Unity 8 15 20 Unity 9 Regula	600 x 600 x 12.5 625 x 625 x 12.5	Demountable, suspended ceiling in visible T-grid with perforation to the edge	42
DANOTILE Edge A		Regula	600 x 600 x 6.5 600 x 600 x 9.5 600 x 1200 x 6.5 600 x 1200 x 9.5 625 x 625 x 9.5	Special purpose hygiene ceiling. Demountable, suspended ceiling in visible T-grid	50
MEDLEY Edge A		Regula	600 x 600 x 9.5	Demountable T-grid ceiling with a matt, dust proof foil surface. Robust ceiling that is easy to mount and clean.	58
ACOUSTICAL PLANK CEILINGS					
CORRIDOR 400 Edge D		Globe Quadril Micro Tangent Regula	400 x 1200 x 9.5 400 x 1800 x 9.5 400 x 2400 x 9.5 400 x L x 9.5	Demountable self-supporting ceiling requiring no hangers, for corridors and narrow rooms. Easy access to cavity	66
CORRIDOR SWING Edge E		Globe Quadril Micro Regula	600 x 1200 x 12.5 600 x 1500 x 12.5 600 x 1800 x 12.5	Hinged ceiling panels for corridors and access areas in non-demountable ceilings, allowing easy access to the cavity and installations.	74

PRODUCT OVERVIEW

PRODUCT	EDGE	PERFORATION	SIZE (mm)	APPLICATION	PAGE
CORRIDOR PLANKS Edge A, D, E	For edges, please go to page 84	Plaza Markant Belgravia Contur	300 x L x 9.5/12.5 Max. length: 2100 mm	Rectangular ceiling modules with free span up to 2100 mm. Available with 4 different edges enabling a range of elegant designs.	82
ACOUSTICAL CEILING PANELS			ACOUSTIC WALL PANELS		
DESIGNPANEL Edge B1		Globe Quadril Micro Tangent Regula	1200 x 2400 x 12.5 900 x 2700 x 12.5 900 x 2400 x 12.5* * (Only Tangent)	Non-demountable ceiling & wall lining Four tapered edges for continuous ceiling and wall design; Possibility of full integration with existing wall construction	Ceiling 86 Wall 148
TECTOPANEL Edge B		Globe Micro Tangent Regula	400 x 600 x 9,5* 600 x 600 x 12,5 600 x 2400 x 12* 625 x 625 x 12,5	Non-demountable ceiling & wall lining. Filling of screw holes and painting required. * R	Ceiling 100 Wall 156
CONTRAPANEL Edge B		Globe Regula	600 x 1200 x 12.5	Special purpose impact resistant ceiling and wall lining for sports halls and gymnasiums	Ceiling 112 Wall 164
DANOPANEL Edge B		Globe Micro Regula	600 x 600 x 12.5	Non-demountable ceiling lining, supplied pre-painted from factory; equipped with hidden fixings. No joint filling required.	120
SOLOPANEL Edge: SK UFF MF	SK  UFF  MF 	G6/18 G8/18 G10/23 G12/25 G15/30 Q8/18 G8/12/50 G12/20/66	For sizes, please go to page 131.	Non-demountable ceiling & wall lining with regular perforation pattern; perforation to the edge leaving a completely homogenous surface	Ceiling 128 Wall 170
STRATOPANEL Edge: SK UFF	SK  UFF 	G8/15/20 G12/20/35	For sizes, please go to page 141.	Non-demountable ceiling & wall lining with random perforation pattern; perforation to the edge leaving a completely homogenous surface	Ceiling 138 Wall 178
KINOPANEL Edge B		Kino	600 x 600 x 12.5	Special purpose wall lining for extraordinary acoustic regulation in cinemas	186
AMFIPANEL Edge B		Tangent	600 x 600 x 12.5 600 x 900 x 12.5	Special purpose wall lining for extraordinary acoustic regulation in cinemas	192
ADIT Edge B	 	Tangent	450 x 2400 x 9.5 450 x 1200 x 9.5	Special purpose wall lining for exceptionally quick and easy acoustic regulation in existing rooms. Minimum disturbance of the daily activities in the rooms.	200

DID YOU KNOW THAT ...

gypsum ($\text{Ca SO}_4 + 2 \text{ H}_2\text{O}$) is a natural material that is also synthetically produced in a reaction of limestone and flue gasses that decrease the SO_2 emissions from power stations thereby reducing acid precipitation?

VISONA

ACOUSTIC CEILING TILES

Flexible acoustic ceiling solution with Drag ,n' Drop function for adaptable placement of ceiling tiles and light fixtures. Installed in double T-grid requiring no cross runners. Easy access to installations.

ACOUSTIC CEILING TILES

VISONA

SIZES

400 x 1200 x 12.5 mm

SURFACE

Standard white painted surface
(closest match RAL 9003, gloss 5)
Other colours available on request

DANISH INDOOR CLIMATE LABELLING (DIM)

Indoor value: 10 days
Particle emission: low (< 0.75 mg)

CLEANING

Dust is removed using a dry duster or vacuum cleaner. Marks can be removed with a damp cloth using normal cleaning practices and neutral cleaning solutions.

AMBIENT CONDITIONS

The product is designed to perform under normal conditions of use. Tested at 70% RH and 25°C. The product can withstand ambient temperatures of up to 50°C.

LIGHT REFLECTION

Tangent: 70.9%
Regula: 82.6%

LOAD-BEARING CAPACITY

1 / A / No load

FIRE CLASS

A2-s1,d0

ROBUSTNESS

Made of robust, glass fibre reinforced material with excellent pressure resistance. Under normal conditions of use, the product properties are preserved and there is no decomposition of material over time.

WEIGHT

Indicative tile weight: 7.6 – 9.8 kg/m².
All according to type of perforation.



CERTIFICATES

- FDES LCA Declaration
- Declaration of Conformity (EN 14190)
- Danish Indoor Climate Labelling

ACOUSTIC CEILING TILES

VISIONA

ACOUSTICS

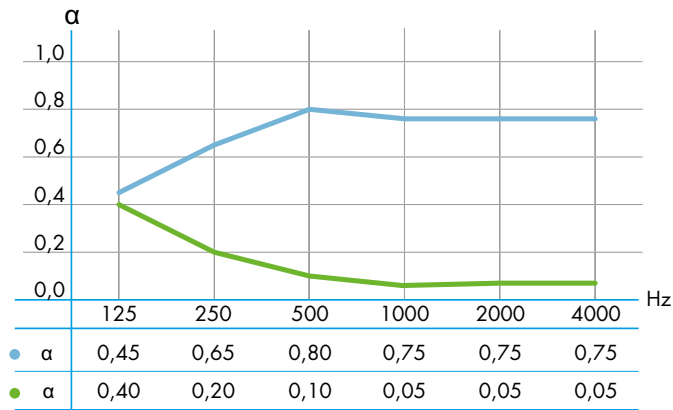

- Tangent, 200 mm suspension, no mineral wool α_w : 0.80, NRC: 0.75
- Regula, 200 mm suspension, no mineral wool α_w : 0.10, NRC: 0.05

For acoustic data on alternative constructions please see "Absorption Data" at knaufdanoline.com

EDGES



Edge E

E lengthwise / B crosswise (tegular / bevelled edge) / S24
 Recessed grid lengthwise / No grid crosswise

For Tangent



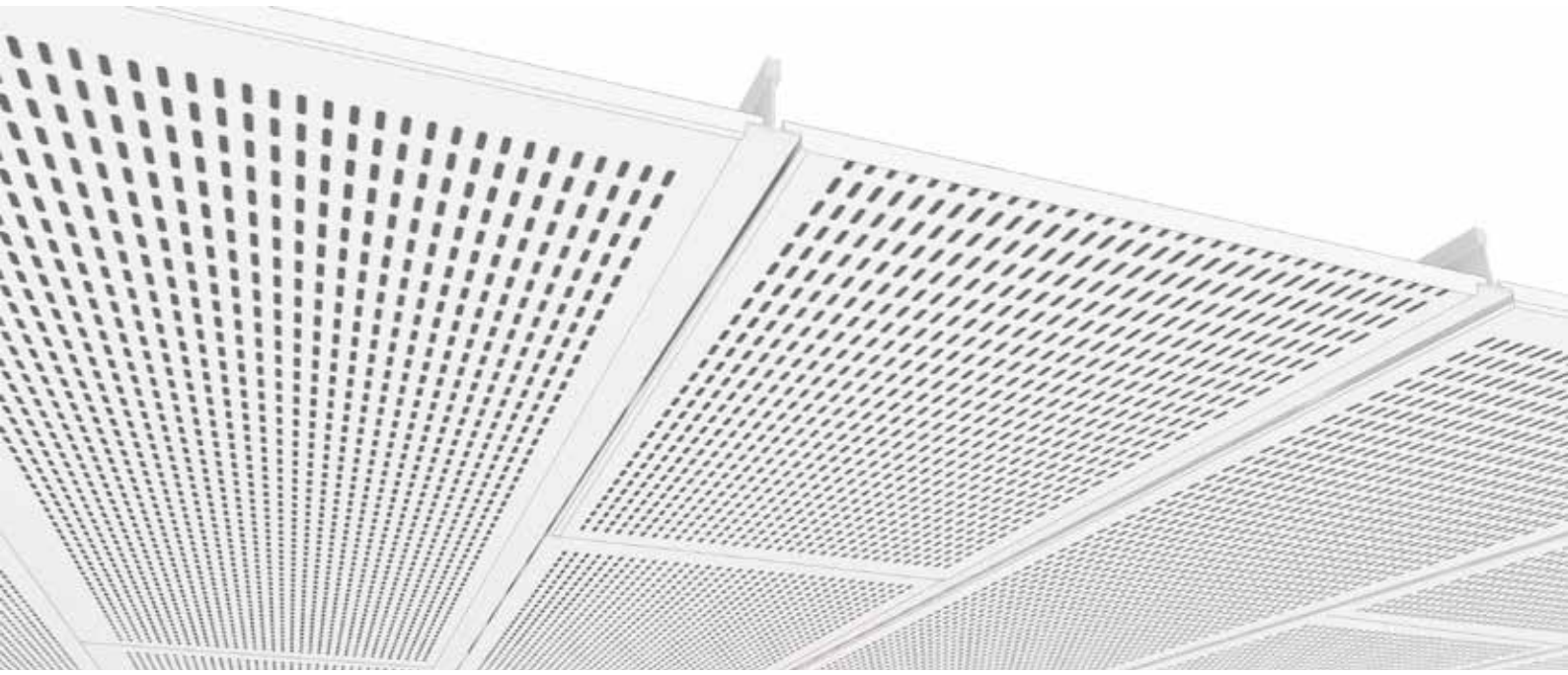

PERFORATION

Also available as Regula.

Other perforation patterns are manufactured to order.



Tangent, 4 x 14 mm
10/20 mm c/c
Perforation: 21.3%

INSTALLATION GUIDE 400 x 1200 mm module

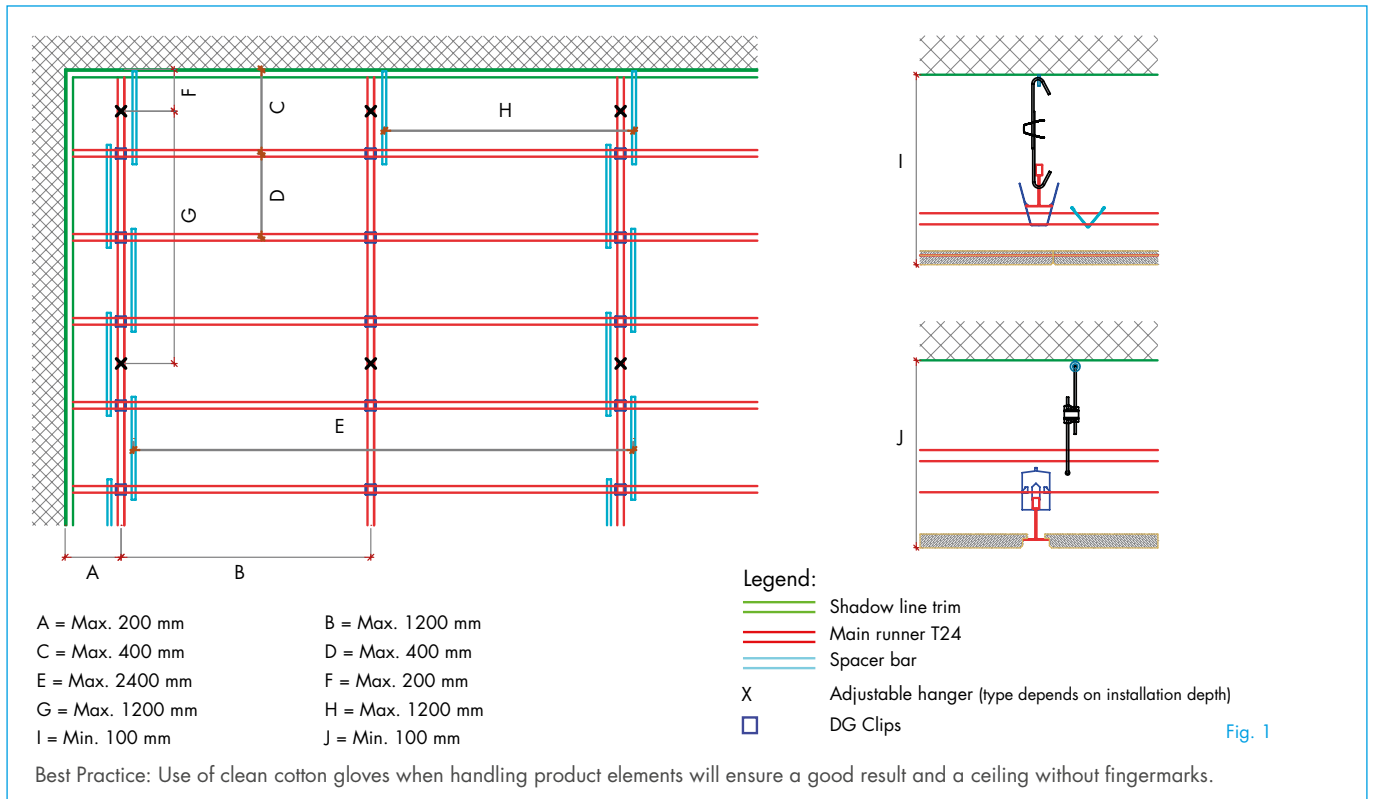
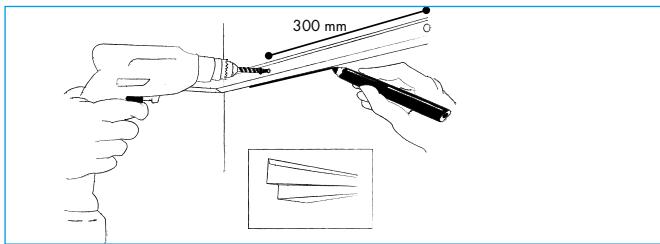
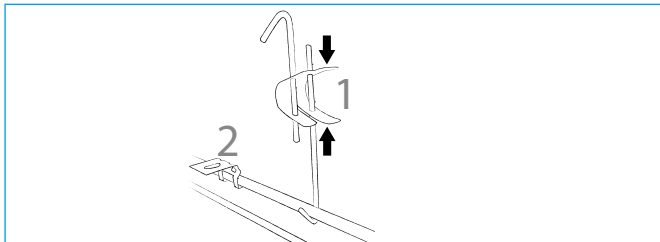

Fig. 1



MARKING AND SHADOW LINE TRIM

- Mark the location of the shadow line trim on the walls and columns in relation to the required ceiling height.
- Install the shadow line trims at max. 300 mm c/c. Choose the method of securing the profiles in accordance with the substrate.



HANGERS

- Fix adjustable hangers (1) with eye screws or similar securely fastened to the primary construction.
- Direct hangers (2) are secured to the ceiling using appropriate fixings in accordance with the substrate.
- Install the first hanger at max. 200 mm from the wall. The other hangers should be installed at max. 1200 mm c/c.
- If loads from light fittings etc. are to be borne by the ceiling, install additional hangers.
- Refer to distances in figure 1.

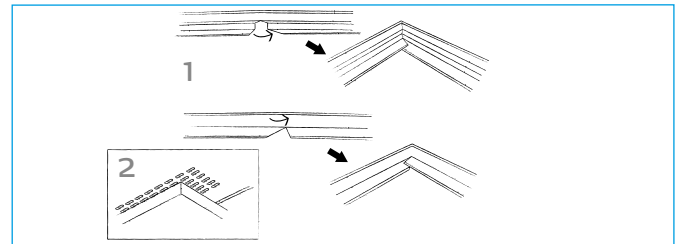

CORNERS

- Inside corners (1): cut the corners in a false mitre letting the ends overlap each other, unless anything to the contrary is specified.
- Outside corners (2): must always be mitred.

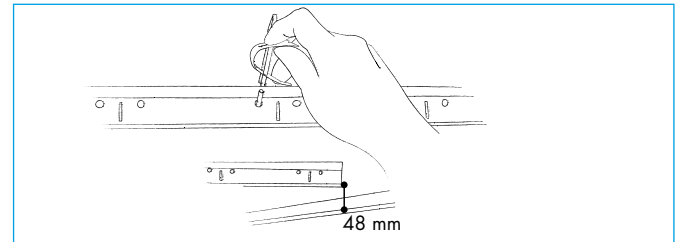

PRIMARY RUNNERS

- Install the runners with the help of hangers. Note that the location of light fittings and ventilation units will have an influence on ceiling layout.
- The lower edge of the primary runner must be 48 mm higher than the height of the finished ceiling.
- Adjust the height of the primary runners before installing the secondary runners.

INSTALLATION GUIDE 400 x 1200 mm module

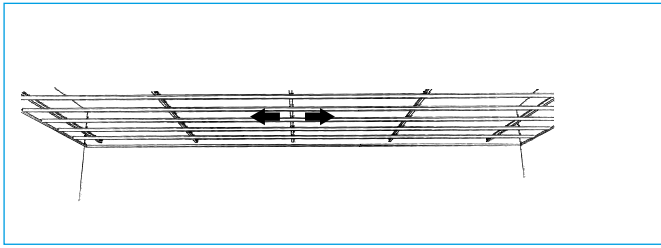

LAYOUT

- Install the secondary runners parallel to each other.

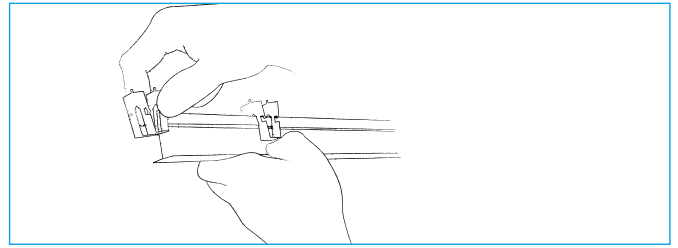

DG CLIPS

- Slide the number of clips necessary over the secondary runner.

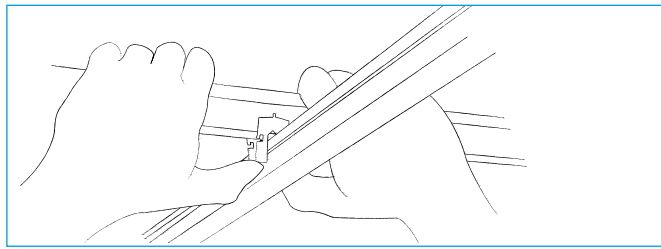

SECONDARY RUNNERS

- Press the DG clip up around the flanges on the primary runner.
- The secondary runner can then be adjusted in both directions.

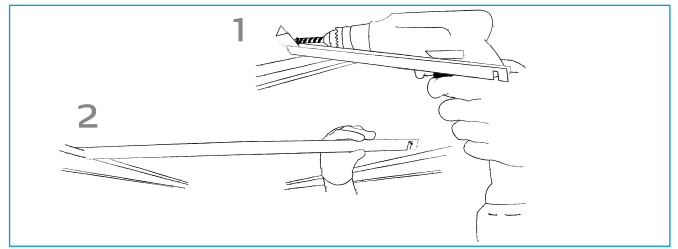

SPACER BARS

- Align the first primary runner along one wall and secure it with the help of adapted spacer bars, which must be screwed to the wall (1).
- Install the remaining spacer bars (2).
- Lock the secondary runner in position by gently pulling them down.

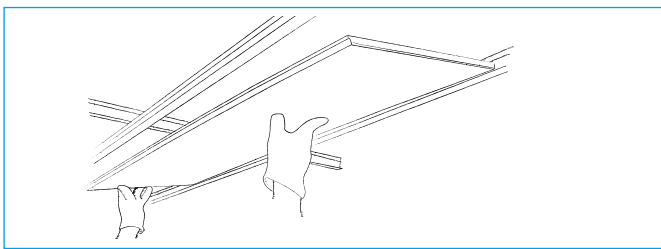

INSTALLATION

- Always wear clean cotton gloves when handling ceiling elements.
- Install the elements by lifting one side of the tile across the flange of the secondary runner, lifting the opposite side and pulling it back so that the tile is resting on its top lip.

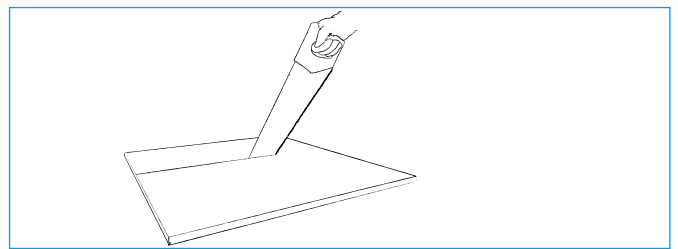

CUTTING

- Cut the elements to size from the front with a fine-toothed saw.
- It is important to cut the tiles in the first and last rows precisely so that they are securely positioned in the system.

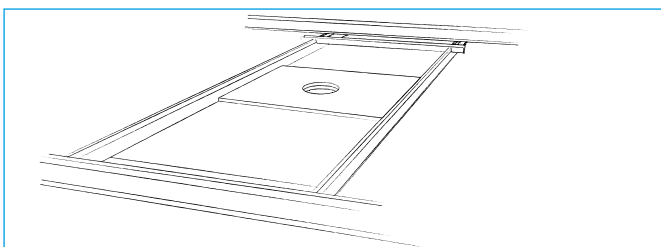

FIXTURES AND FITTINGS





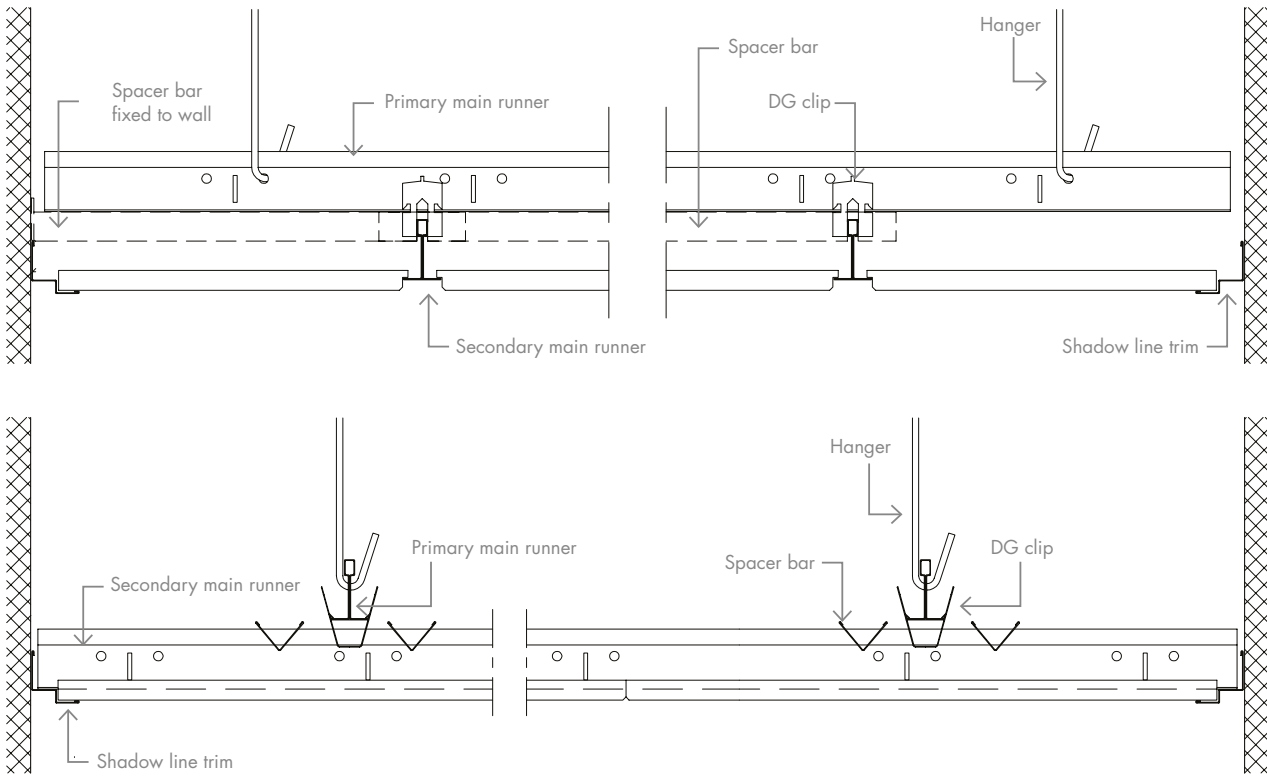

- With smaller units (of up to 3kg) a reinforcement panel of sufficient strength can be installed behind the Visona element.
- The reinforcement panel must extend all the way into the main runners, so that the weight is transferred to them.
- The total weight should not be greater than 3kg for each m² of ceiling. Where loads are greater than 3kg/m², additional hangers must be used.
- Units over 3kg, should be installed independently, so that they do not place any load on the ceiling.

DETAILS

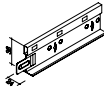
VISONA IN DOUBLE GRID SYSTEM S24 DIRECT TO WALL WITH SHADOW LINE TRIM

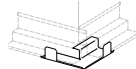
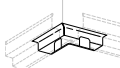

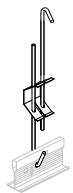
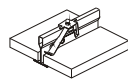
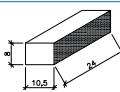
ACCESSORIES

PRODUCT NAME		SAP NO.	W x L x H (mm)
Main runner T24		467385	24 x 3700 x 38
Shadow line trim type MS15		316335	15+15 x 3000 / 8+25
Spacer bar		199032	L: 400
Outside corner for wall angle		316310	for 15 mm Shadow line trim
Inside corner for wall angle		316312	for 15 mm Shadow line trim
DG-clips		199022	-
Direct hanger		431912 316304 316302	50 80 100
Adjustable hanger The size specification indicates the min. and max. range		469861 469868 469872 469876 469878 469880 469881	165 - 280 315 - 580 510 - 970 630 - 1210 755 - 1460 900 - 1750 1020 - 1990
Hold down clip		430744	-
Plug for Visona w/24 mm T-profiles in wall angle 316335		430864	8x10.5x24
Hanger clip		198242	-
Lamp hanger		198896	-



DID YOU KNOW THAT ...

it is possible to make V-cuts in gypsum boards so you can mitre the boards to create sharp angles?



CONTUR

ACOUSTIC CEILING TILES

Elegant unified look with no visible T-grid. Demountable ceiling requiring low installation depth. Perfect look for combination with perforated wall linings. Fixed frieze possibilities to provide an elegant connection between ceiling and wall.

ACOUSTIC CEILING TILES

CONTUR

SIZES

600 x 600 x 12.5 mm

625 x 625 x 12.5 mm

SURFACE

Standard white painted surface (closest match RAL 9003, gloss 5). Other colours available on request

DANISH INDOOR CLIMATE LABELLING (DIM)

Indoor value: 10 days. Particle emission: low (< 0.75 mg)

CLEANING

Dust is removed using a dry duster or vacuum cleaner. Marks can be removed with a damp cloth using normal cleaning practices and neutral cleaning solutions.

AMBIENT CONDITIONS

The product is designed to perform under normal conditions of use. Tested at 70% RH and 25°C. The product can withstand ambient temperatures of up to 50°C.

LIGHT REFLECTION

Globe: 72.8%

Quadril: 75.1%

Micro: 72.1%

Regula: 82.6%

Unity 3: 69.2%

Unity 4: 72.5%

Unity 8 | 15 | 20: 72.2%

Unity 9: 71.6%

LOAD-BEARING CAPACITY

1 / A / No load

FIRE CLASS

A2-s1,d0

ROBUSTNESS

Made of robust, glass fibre reinforced material with excellent pressure resistance. Under normal conditions of use, the product properties are preserved and there is no decomposition of material over time.

WEIGHT

Indicative tile weight: 9.45 – 10.20 kg/m².

All according to type of perforation.



CERTIFICATES

- FDES LCA Declaration
- Declaration of Conformity (EN 14190)
- Danish Indoor Climate Labelling

ACOUSTIC CEILING TILES

CONTUR

ACOUSTICS

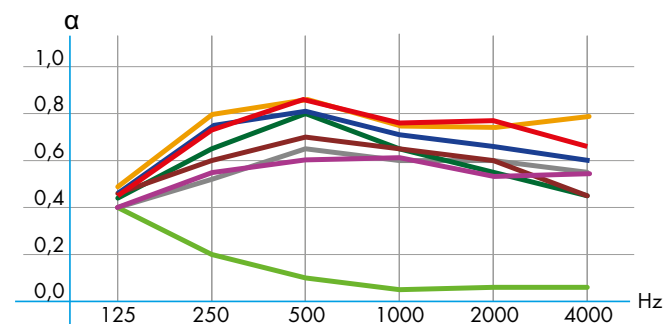

	125	250	500	1000	2000	4000
● α	0,45	0,65	0,80	0,65	0,55	0,45
● α	0,45	0,60	0,70	0,65	0,60	0,45
● α	0,40	0,55	0,65	0,60	0,60	0,55
● α	0,50	0,80	0,85	0,75	0,75	0,80
● α	0,45	0,75	0,80	0,70	0,65	0,60
● α	0,40	0,55	0,60	0,60	0,50	0,50
● α	0,45	0,75	0,85	0,75	0,75	0,65
● α	0,40	0,20	0,10	0,05	0,05	0,05

- Globe, 200 mm suspension, no mineral wool aw: 0.60, NRC: 0.65
- Quadril, 200 mm suspension, no mineral wool aw: 0.60, NRC: 0.65
- Micro, 200 mm suspension, no mineral wool aw: 0.65, NRC: 0.60
- Unity 3, 200 mm suspension, no mineral wool aw: 0.80, NRC: 0.80
- Unity 4, 200 mm suspension, no mineral wool aw: 0.70, NRC: 0.75
- Unity 8 | 15 | 20, 200 mm suspension, no mineral wool aw: 0.60, NRC: 0.55
- Unity 9, 200 mm suspension, no mineral wool aw: 0.75, NRC: 0.80
- Regula, 200 mm suspension, no mineral wool aw: 0.10, NRC: 0.05

For acoustic data on alternative constructions please see "Absorption Data" at knaufdanoline.com

EDGES



Edge D
(rebated and grooved) / S24
Concealed grid
For Globe, Quadril and Micro

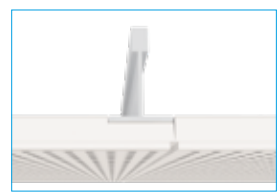

Edge D-Plus [D+]
Concealed grid
For Unity 3, Unity 4, Unity 9
and Unity 8 | 15 | 20



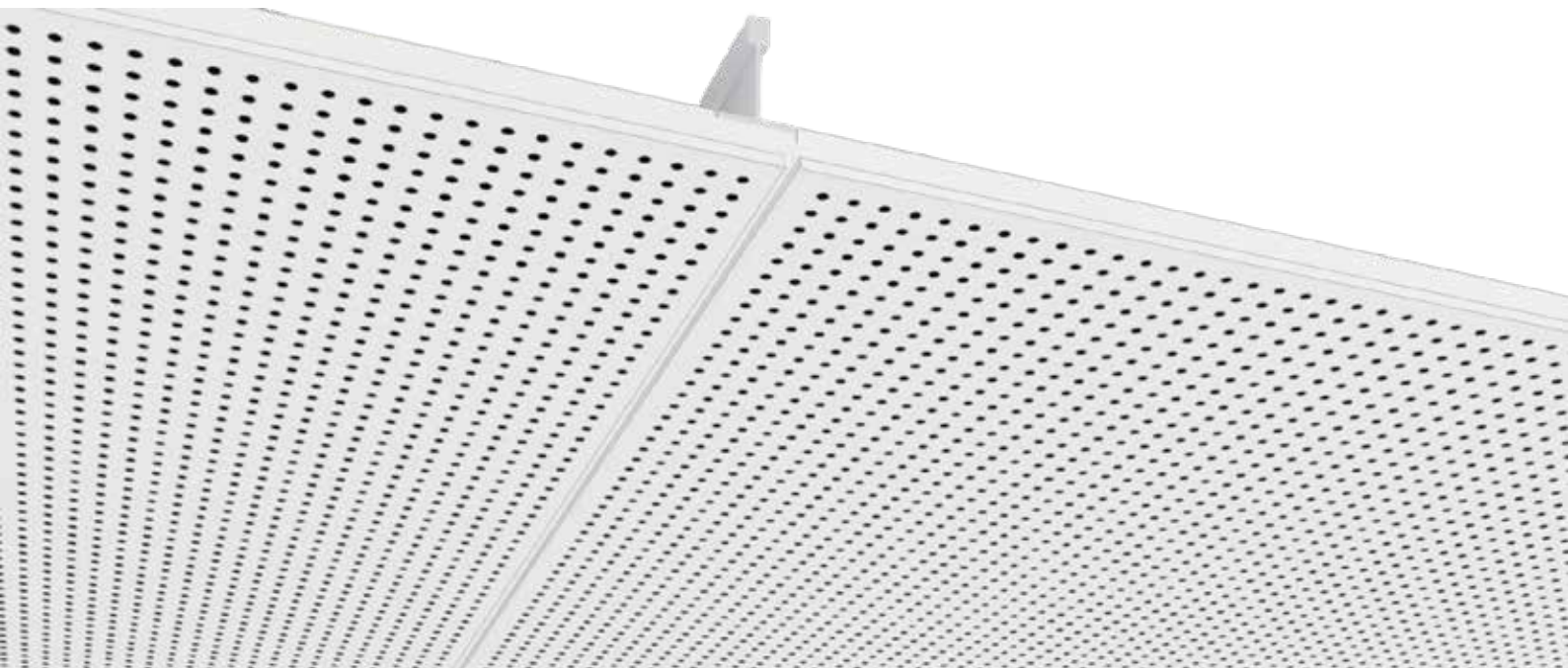

PERFORATION

Also available as Regula.

Other perforation patterns are manufactured to order.



Globe, Ø6 mm,
15 mm c/c
Perforation: 10.2%



Quadril, 12 x 12 mm,
30 mm c/c
Perforation: 13%



Micro, 3 x 3 mm,
8.3 mm c/c
Perforation: 10.2%



Unity 3, 3.5 x 3.5 mm,
8½ mm c/c
Perforation: 17.2%

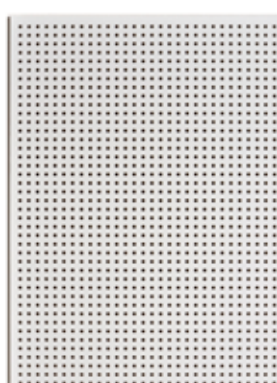

Unity 4, Ø4 mm,
10 mm c/c
Perforation: 12.2%



Unity 8|15|20,
Ø8 mm, Ø15 mm, Ø20 mm
Perforation: 10.8%

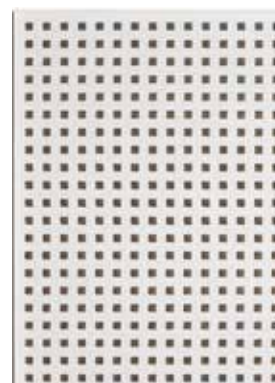

Unity 9, 9 x 9 mm,
20 mm c/c
Perforation: 18.9%

INSTALLATION GUIDE 600 x 600 mm module

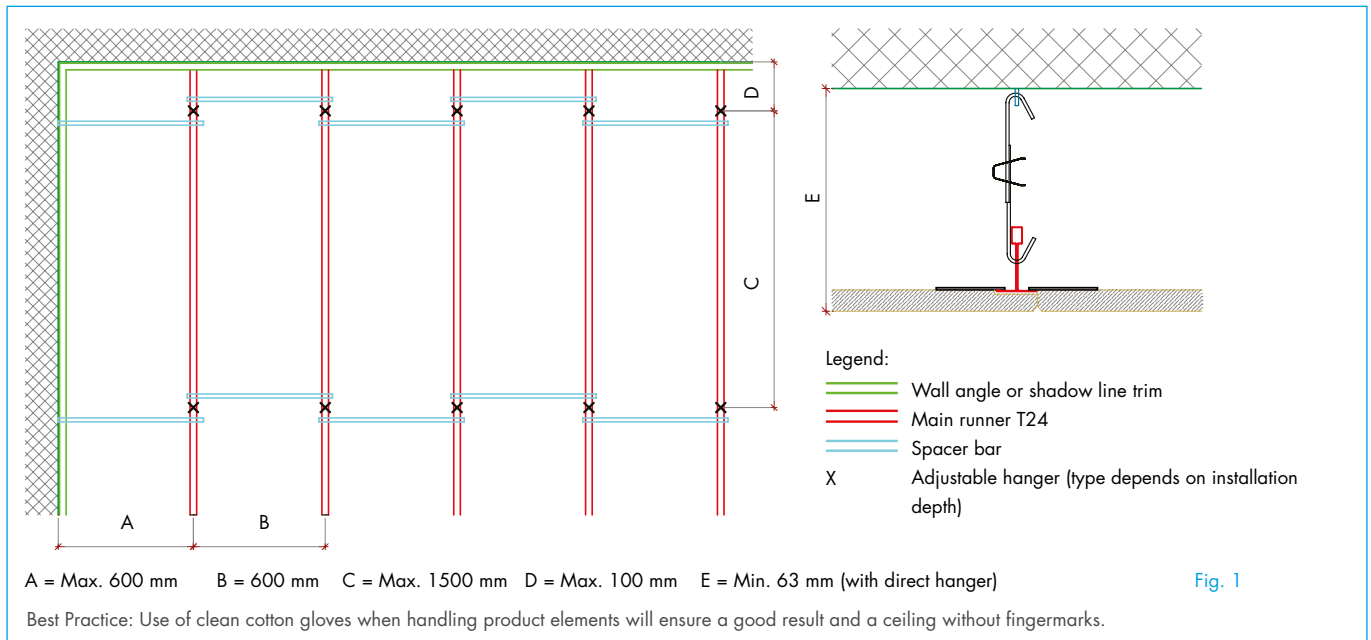
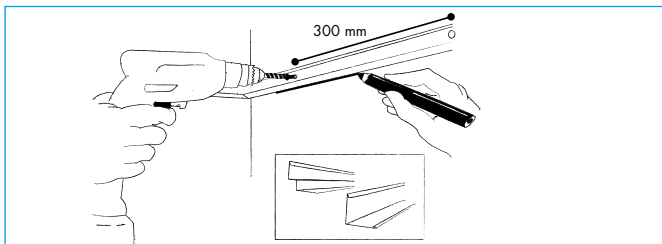
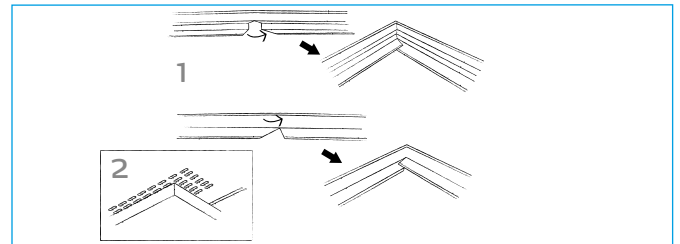

Fig. 1



MARKING AND WALL ANGLES

- Mark the location of the wall angles on the walls and columns in relation to the required ceiling height.
- Install the wall angles at max. 300 mm c/c. Choose the fixings in accordance with the substrate.



CORNERS

- Inside corners (1): cut the corners in a false mitre letting the ends overlap each other, unless anything to the contrary is specified. Finish with a corner cover, if necessary.
- Outside corners (2): must always be mitred. Finish with a corner cover if necessary.

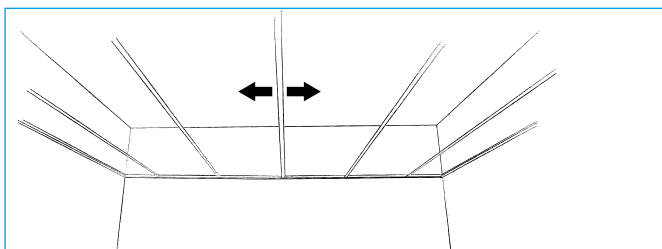

CEILING LAYOUT

- Divide the ceiling surface from the centre of the room or in accordance with the existing ceiling plans.
- The location of light fittings and ventilation units will have an influence on ceiling layout.
- Install the first main runner at max. 600 mm from the wall. The other main runners should be installed at 600 mm c/c (based on module 600).

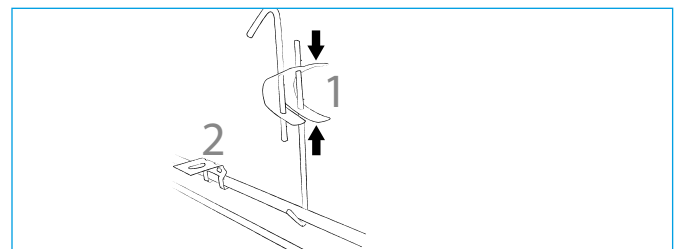

HANGERS

- Fix adjustable hangers (1) with eye screws or similar securely fastened to the primary construction.
- Direct hangers (2) are secured to the ceiling using appropriate fixings in accordance with the substrate.
- Install the first hanger at max. 100 mm from the wall. The other hangers should be installed at max. 1500 mm c/c.
- If loads from light fittings etc. are to be borne by the ceiling, install additional hangers.
- Refer to distances in figure 1.

INSTALLATION GUIDE 600 x 600 mm module

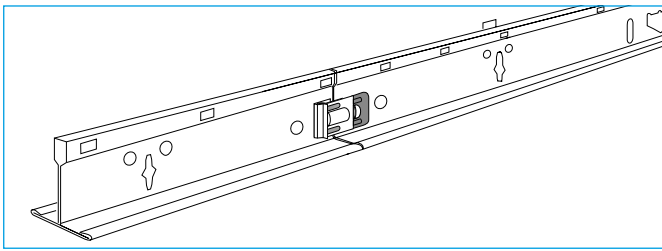

MAIN RUNNERS

- Install the main runners parallel to each other so that the slots are directly opposite each other.
- Join the main runners longitudinally by clicking them together.
- Adjust the lengths of the profiles with plate shears, a hacksaw or a cross-cut saw with a special blade.
- Make sure there is a hanger between the end joints of the main runners and the fire break.

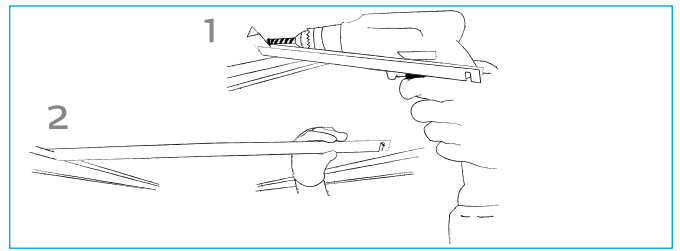

SPACER BARS

- Align the first main runner along one of the walls and secure it with the help of adjusted spacer bars screwed into the wall (1).
- Install the other spacer bars (2).
- NB! When using 50 mm direct hangers, the spacer bars must be installed at the same time as the main runners (or it will not be possible to install the spacer bars).

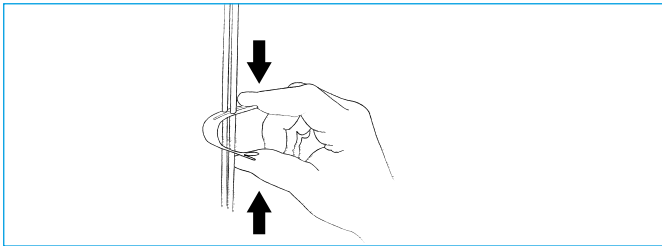

ADJUSTMENT

- Check that all profiles are at correctly aligned when the entire suspension grid has been installed.
- Adjust the hangers so that they are taut and the ceiling surface is level.

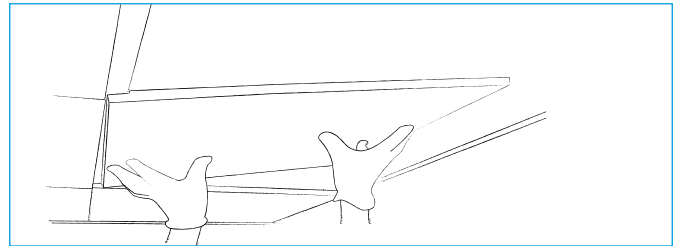

INSTALLATION

- Always wear clean cotton gloves when handling ceiling elements.
- Install the elements by lifting the "male" side up across the one main runner, then push the "female" side into position on the opposing main runner and lower the "male" side on the first main runner.
- Check that all metal clips are resting on the main runner.

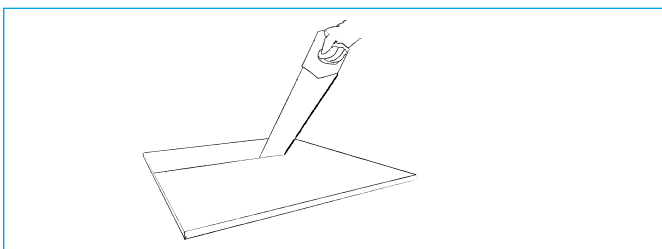

CUTTING AND FINISHING

- Cut the elements to size from the front with a fine-toothed saw.
- If metal clips are installed in the place where the element is to be cut, they must be removed first.
- Grip the metal with a pair of pliers and twist it off gently.
- A new metal clip can be pressed into position with a clip mouting tool available from Knauf Danoline.

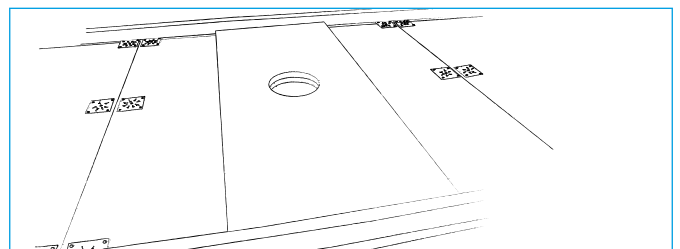

FIXTURES AND FITTINGS

- With smaller units (of up to 3kg) a reinforcement panel of sufficient strength can be installed behind the Contur element.
- The reinforcement panel must extend all the way into the main runners, so that the weight is transferred to them.
- The total weight should not be greater than 3kg for each m² of ceiling. Where loads are greater than 3kg/m², additional hangers must be used.
- Units over 3kg, should be installed independently, so that they do not place any load on the ceiling.

DETAILS



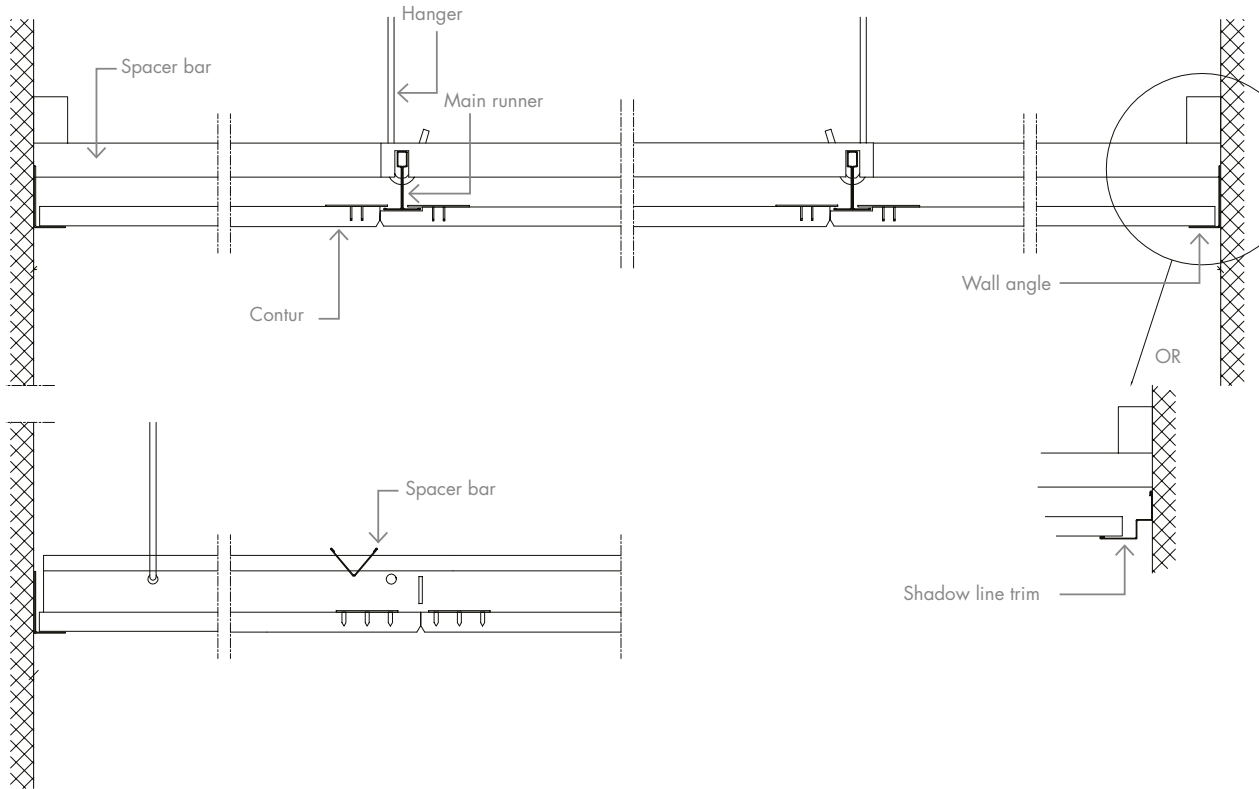



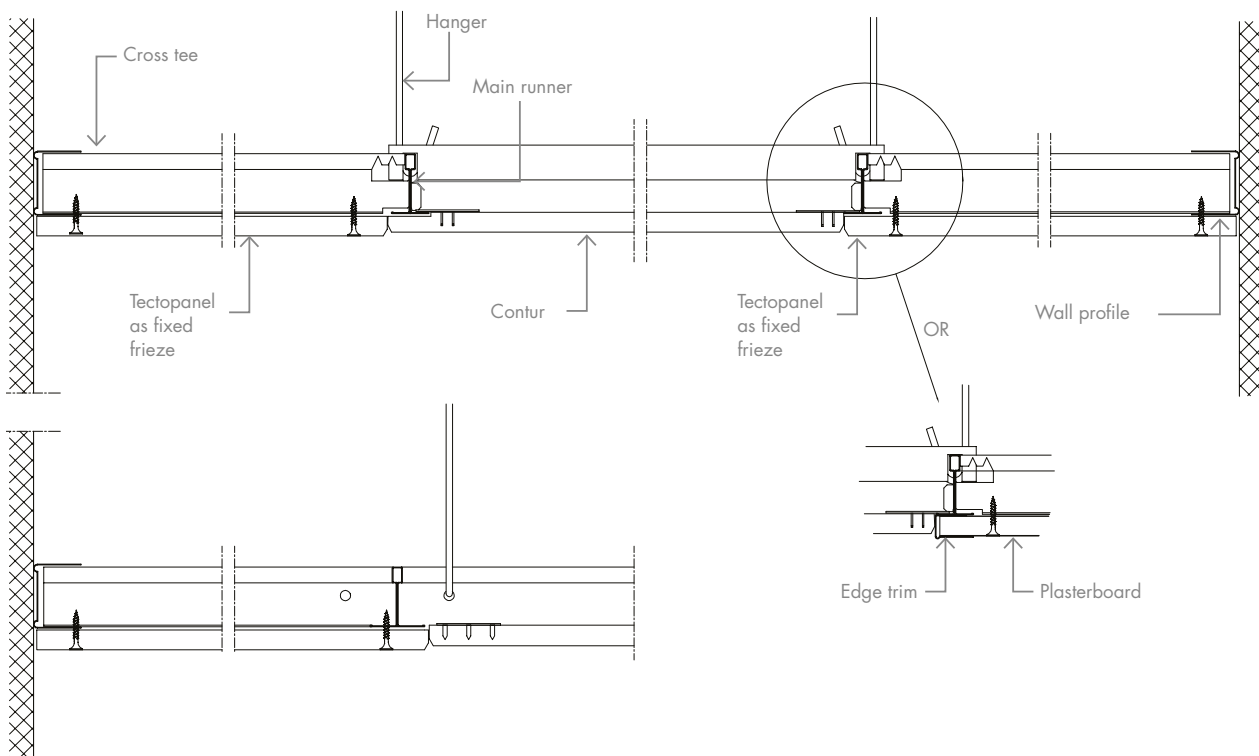

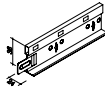
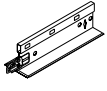

CONTUR IN GRID SYSTEM S24 DIRECT TO WALL

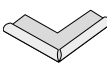
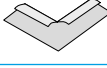
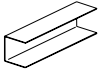

CONTUR IN GRID SYSTEM S24 WITH FIXED FRIEZE

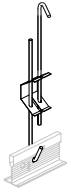
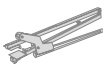

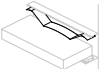
ACCESSORIES

PRODUCT NAME	SAP NO.	W x L x H (mm)
Main runner T24 	467385	24 x 3700 x 38
Cross tee T40 (galvanized) 	316299 316297	40 x 600 x 38 40 x 1200 x 38
Spacer bar 	510647	600
Wall angle type MIE2024 	434023	20 x 3000 x 24
Shadow line trim type MS10 	316330	19+11 x 3000 / 13+19
Outside corner for wall angle 	109100 172920	for 24 mm Wall angle for 19 mm Wall angle
Inside corner for wall angle 	109102 172921	for 24 mm Wall angle for 19 mm Wall angle
Wall profile 	316346	32 x 3000 x 41
Direct hanger 	431912 316304 316302	50 80 100
Adjustable hanger The size specification indicates the min. and max. range 	469861 469868 469872 469876 469878 469880 469881	165 - 280 315 - 580 510 - 970 630 - 1210 755 - 1460 900 - 1750 1020 - 1990
Fixing tool for clips 	198353	-
Clips 	198364	40 x 40 x 1/11
Clips 	198365	40 x 40 x 1/10
Wall clip 	108961	-
Hold down clip 	113734	-
Repair kit White paint for pre-painted tiles 	198956	-

DANOPOR

Extra sound absorption and reduction as backing.

Mineral wool backing sealed in plastic bags.

No risk of dust particles.

SIZES

600 x 600 x 25 mm

600 x 600 x 50 mm



DID YOU KNOW THAT ...

in nature, when limestone and smoke particles from volcanos come in contact with water, the crystal $\text{Ca SO}_4 + \text{H}_2\text{O}$ is produced? The Beerenberg volcano on Jan Meyen is the reason for large quantities of natural gypsum found around the world today.

BELGRAVIA

ACOUSTIC CEILING TILES

Recessed grid look with discreet shading. Classic and highly robust acoustic ceiling. Exceptionally easy to install and demount.

ACOUSTIC CEILING TILES

BELGRAVIA

SIZES

600 x 600 x 12.5 mm
 625 x 625 x 12.5 mm

SURFACE

Standard white painted surface (closest match RAL 9003, gloss 5). Other colours available on request

DANISH INDOOR CLIMATE LABELLING (DIM)

Indoor value: 10 days. Particle emission: low (< 0.75 mg)

CLEANING

Dust is removed using a dry duster or vacuum cleaner. Marks can be removed with a damp cloth using normal cleaning practices and neutral cleaning solutions.

AMBIENT CONDITIONS

The product is designed to perform under normal conditions of use. Tested at 90% RH and 30°C. The product can withstand ambient temperatures of up to 50°C.

LIGHT REFLECTION

Globe: 72.8%	Unity 3: 69.2%
Quadril: 75.1%	Unity 4: 72.5%
Micro: 72.1%	Unity 8 15 20: 72.2%
Tangent: 70.9%	Unity 9: 71.6%
Regula: 82.6%	

LOAD-BEARING CAPACITY

1 / A / No load	600 x 600 625 x 625	Globe, Quadril, Micro, Tangent, Regula, Unity 3, Unity 4, Unity 9 Unity 8 15 20
2 / A / 30 N	600 x 600 625 x 625	Globe, Quadril, Micro, Regula
2 / B / No load	600 x 600 625 x 625	Globe, Quadril, Micro, Regula

FIRE CLASS

A2-s1,d0

ROBUSTNESS

Made of robust, glass fibre reinforced material with excellent pressure resistance. Under normal conditions of use, the product properties are preserved and there is no decomposition of material over time.

WEIGHT

Indicative tile weight: 9.20 – 9.90 kg/m².
 All according to type of perforation.



CERTIFICATES

- FDES LCA Declaration
- Declaration of Conformity (EN 14190)
- Danish Indoor Climate Labelling

ACOUSTIC CEILING TILES BELGRAVIA

ACOUSTICS

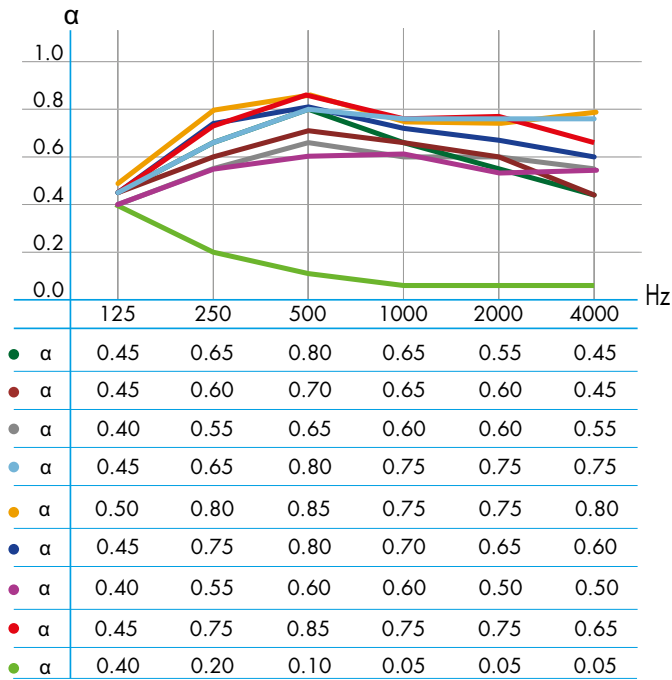

- Globe, 200 mm suspension, no mineral wool aw: 0.60, NRC: 0.65
- Quadril, 200 mm suspension, no mineral wool aw: 0.60, NRC: 0.65
- Micro, 200 mm suspension, no mineral wool aw: 0.65, NRC: 0.60
- Tangent, 200 mm suspension, no mineral wool aw: 0.80, NRC: 0.75
- Unity 3, 200 mm suspension, no mineral wool aw: 0.80, NRC: 0.80
- Unity 4, 200 mm suspension, no mineral wool aw: 0.70, NRC: 0.75
- Unity 8 | 15 | 20, 200 mm suspension, no mineral wool aw: 0.60, NRC: 0.55
- Unity 9, 200 mm suspension, no mineral wool aw: 0.75, NRC: 0.80
- Regula, 200 mm suspension, no mineral wool aw: 0.10, NRC: 0.05

For acoustic data on alternative constructions please see "Absorption Data" at knaufdaneline.com

EDGES



Edge E
(TEGULAR) / S15 OR S24
Recessed grid
For Globe, Quadril, Micro
and Tangent

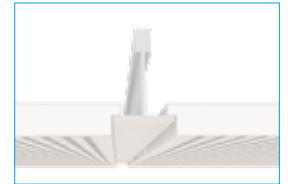

Edge E-Plus [E+]
(TEGULAR) / S15 OR
S24 Recessed grid
For Unity 3, Unity 4,
Unity 9 and U 8 | 15 | 20

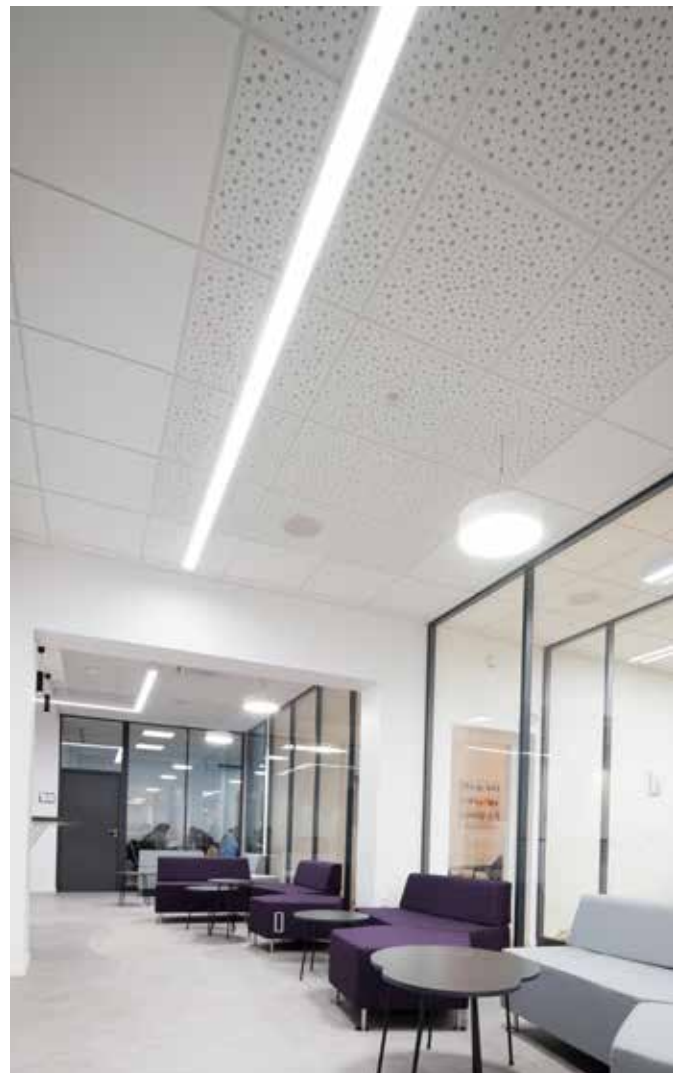

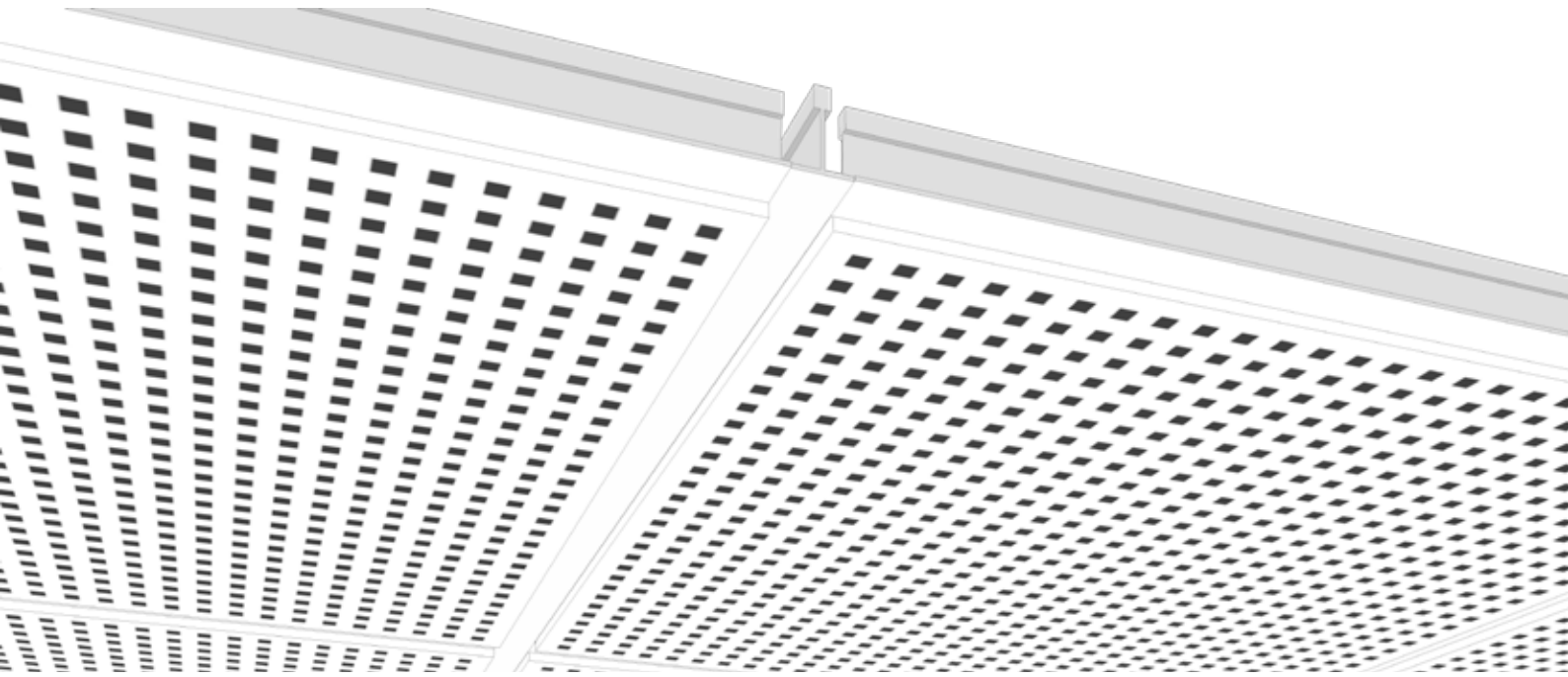

PERFORATION

Also available as Regula.

Other perforation patterns are manufactured to order.



Globe, Ø6 mm,
15 mm c/c
Perforation: 10.2%



Quadril, 12 x 12 mm,
30 mm c/c
Perforation: 13%



Micro, 3 x 3 mm,
8.3 mm c/c
Perforation: 10.2%



Tangent, 4 x 14 mm,
10/20 mm c/c
Perforation: 21.3%

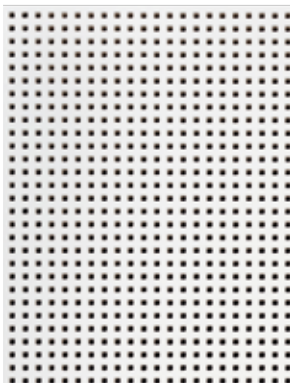

Unity 3, 3.5 x 3.5 mm,
8½ mm c/c
Perforation: 17.2%

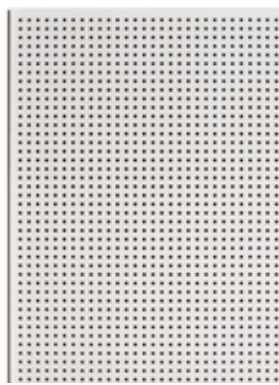

Unity 4, Ø4 mm,
10 mm c/c
Perforation: 12.2%



Unity 8 | 15 | 20,
Ø8 mm, Ø15 mm, Ø20 mm
Perforation: 10.8%

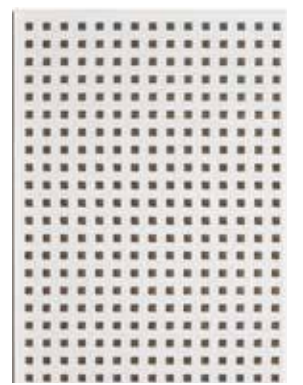

Unity 9, 9 x 9 mm,
20 mm c/c
Perforation: 18.9%

INSTALLATION GUIDE 600 x 600 mm module

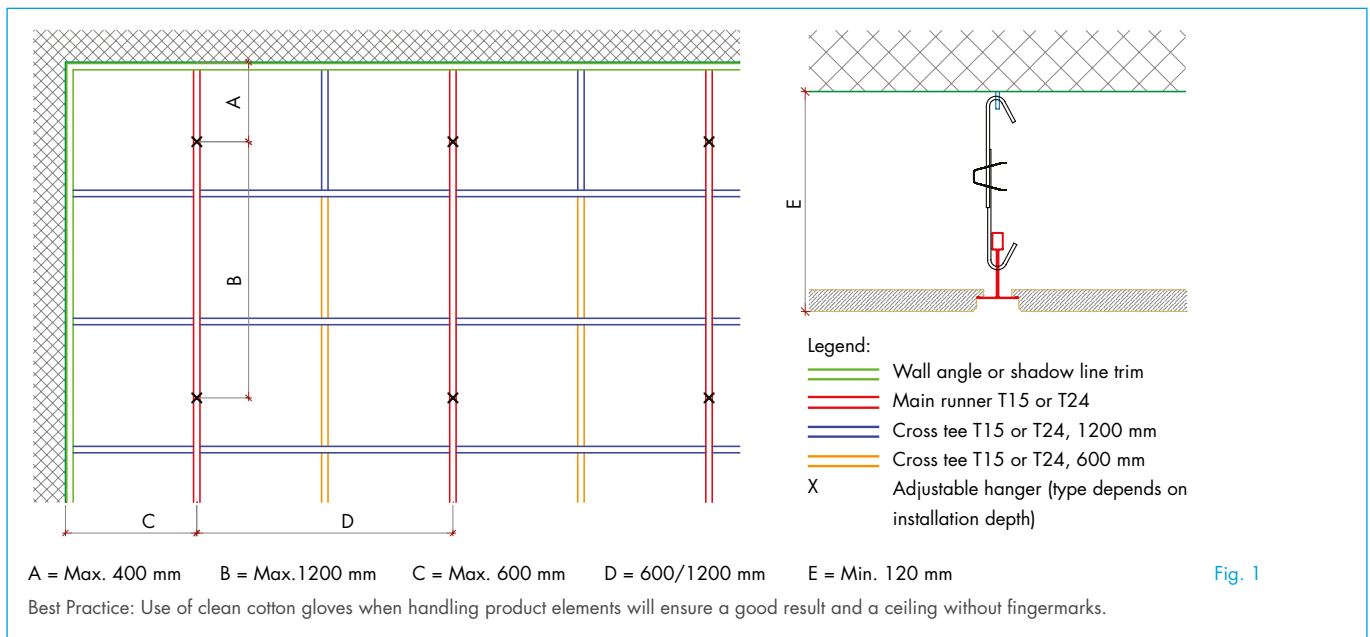
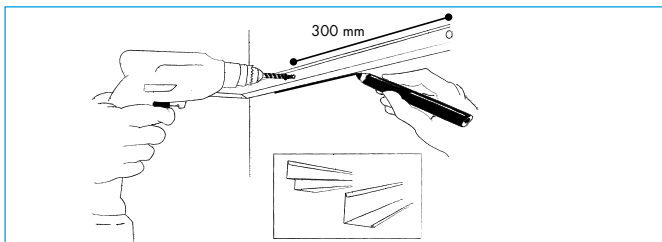
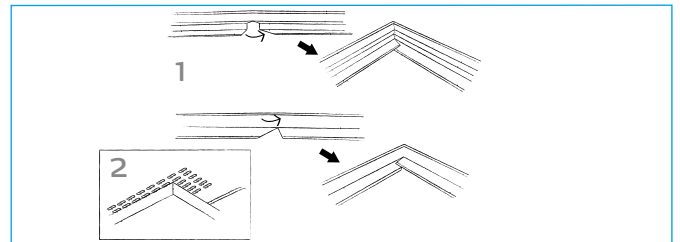

Fig. 1



MARKING AND WALL ANGLES

- Mark the location of the wall angles on the walls and columns in relation to the required ceiling height.
- Fix the wall angles at max. 300 mm c/c. Choose the fixings in accordance with the substrate.



CORNERS

- Inside corners (1): cut the corners in a false mitre letting the ends overlap each other, unless anything to the contrary is specified.
- Outside corners (2): must always be mitred.

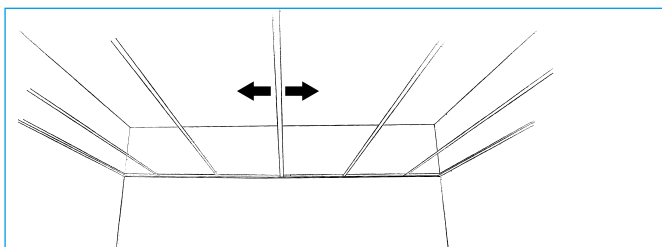

CEILING LAYOUT

- Divide the ceiling surface from the centre of the room or in accordance with the existing ceiling plans.
- The location of light fittings and ventilation units will have an influence on ceiling layout.
- The first main runner is installed at max. 600 mm from the wall. The other main runners should be installed at 600/1200 mm c/c.

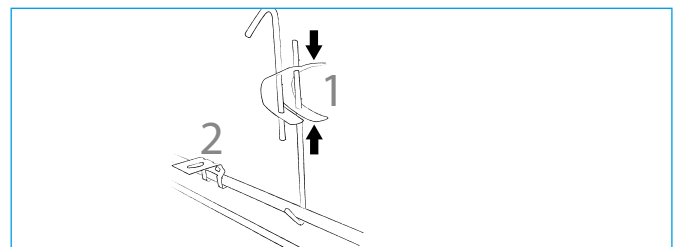

HANGERS

- Fix adjustable hangers (1) with eye screws or similar securely fastened to the primary construction.
- Direct hangers (2) are secured to the ceiling using appropriate fixings in accordance with the substrate.
- Install the first hanger at max. 400 mm from the wall. The other hangers should be installed at max. 1200 mm c/c.
- If loads from light fittings etc. are to be borne by the ceiling, install additional hangers.
- Refer to distances in figure 1.

INSTALLATION GUIDE 600 x 600 mm module

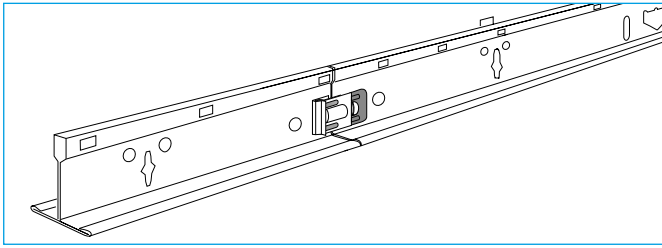

MAIN RUNNERS

- Install the main runners parallel to each other so that the slots are directly opposite each other.
- Join the main runners longitudinally by clicking them together.
- Adjust the lengths of the profiles with plate shears, a hacksaw or a cross-cut saw with a special blade.
- Make sure there is a hanger between the end joints of the main runners and the fire break.

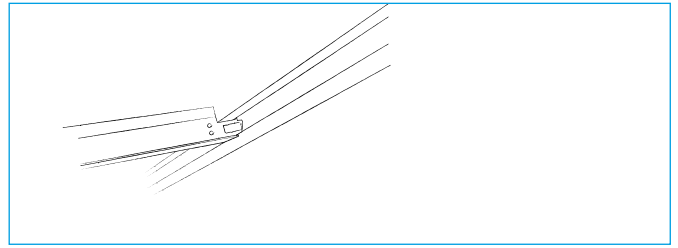

CROSS PROFILES

- Push the snap-in tongue into the slot on the main runner until it securely clicks into place.
- If there is a cross profile on the opposite side of the main runner, the new one must be on the left hand side of the one already in place.

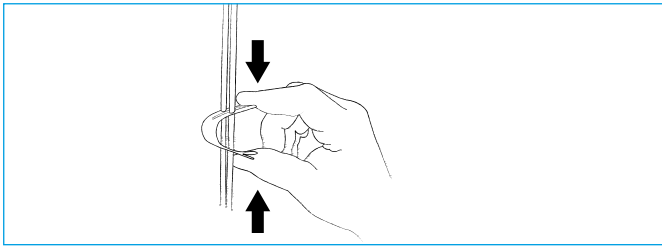

ADJUSTMENT

- Check that all profiles are correctly aligned when the entire suspension grid has been installed.
- Adjust the hangers so that they are taut and the ceiling surface is level.

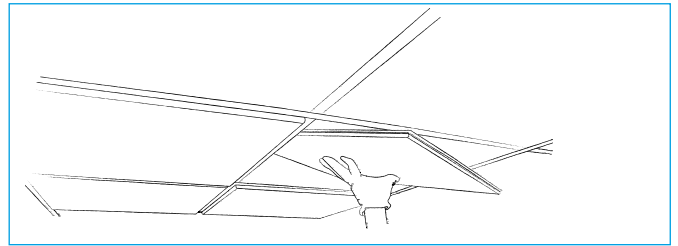

INSTALLATION

- Always wear clean cotton gloves when handling ceiling elements.
- Install the elements by tilting them up between the T-profiles.

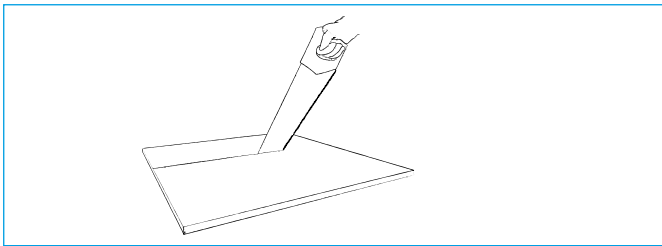

CUTTING

- Cut the elements to size from the front face with a fine-toothed saw.

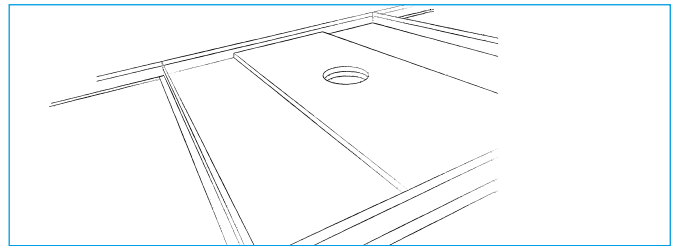

FIXTURES AND FITTINGS

- For sizes up to 625x625 not in Tangent and Unity perforations, units of up to 3kg can be installed directly into the panel without reinforcement.
- For larger module sizes and all sizes with Tangent perforation a reinforcement panel of sufficient strength can be installed behind the Belgravia element.
- The reinforcement panel must extend all the way into the main runners, so that the weight is transferred to them.
- The total weight should not be greater than 3kg for each m² of ceiling. Where loads are greater than 3kg/m², additional hangers must be used.
- Units over 3kg, should be installed independently, so that they do not place any load on the ceiling.

DETAILS

BELGRAVIA IN GRID SYSTEM S15 OR S24 DIRECT TO WALL

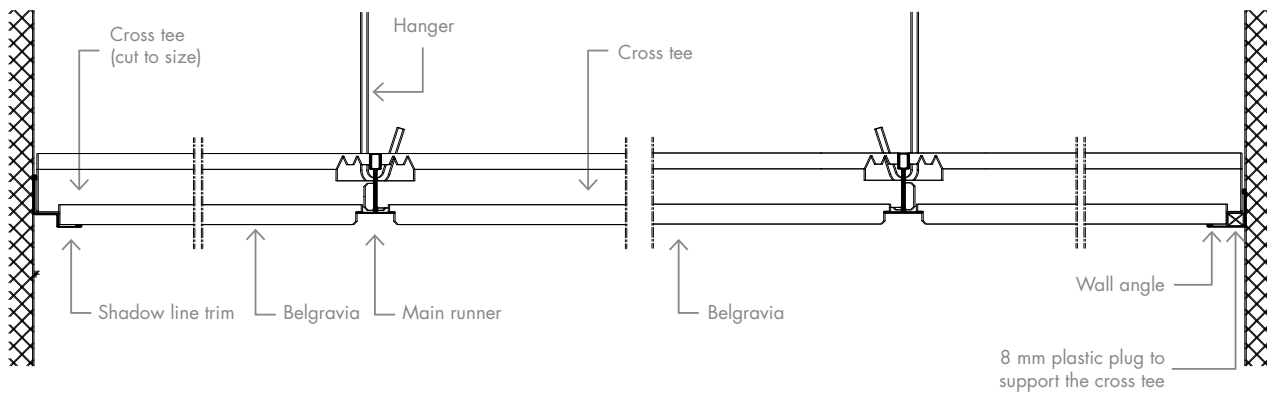

BELGRAVIA IN GRID SYSTEM S15 OR S24 WITH PLAZA FRIEZE

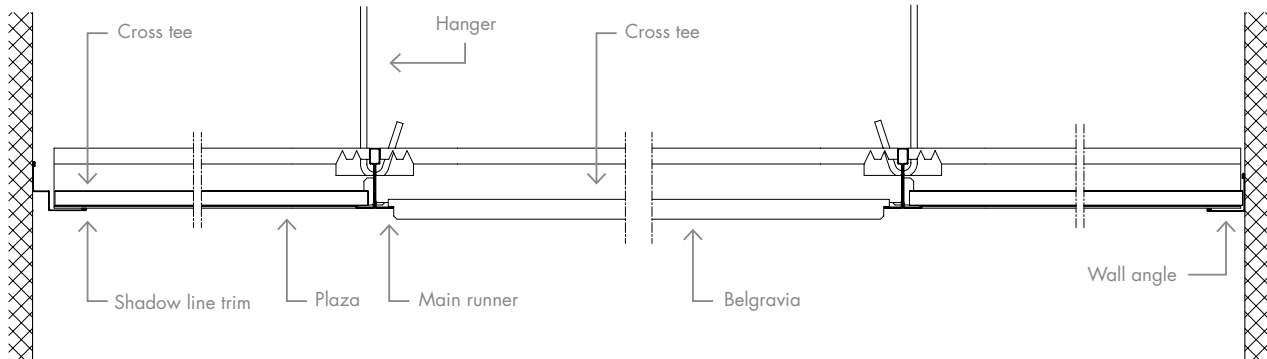



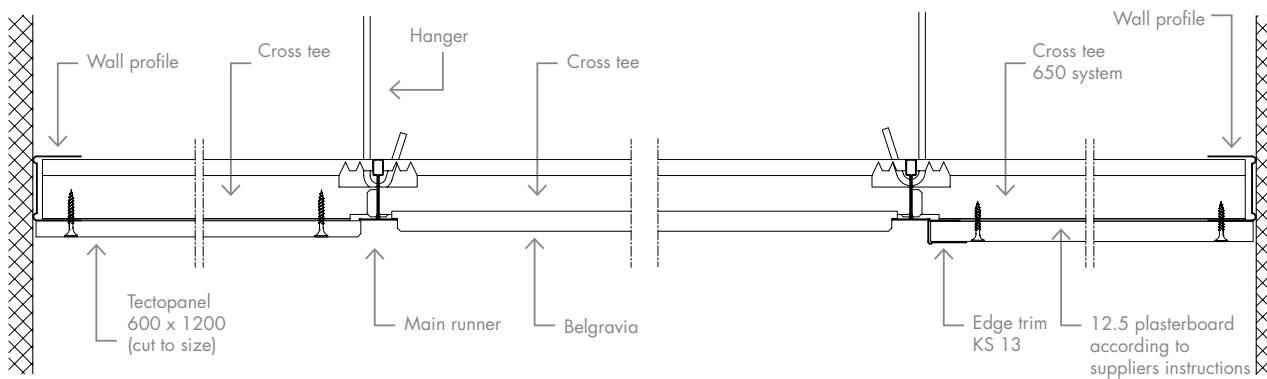



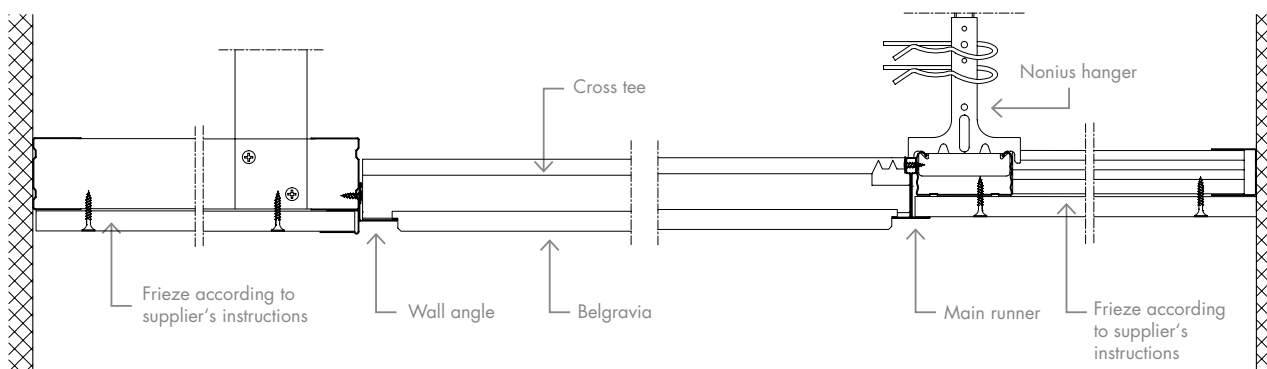

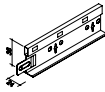
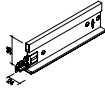
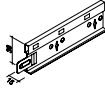
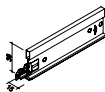
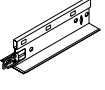

BELGRAVIA IN GRID SYSTEM S15 OR S24 WITH FIXED FRIEZE ON T-PROFILES

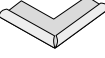

BELGRAVIA IN GRID SYSTEM S15 OR S24 WITH ALTERNATIVE FRIEZE SOLUTIONS

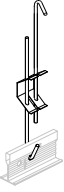

ACCESSORIES

PRODUCT NAME	SAP NO.	W x L x H (mm)
Main runner T24 	467385	24 x 3700 x 38
Cross tee T24 	467388 467389	24 x 600 x 38 24 x 1200 x 38
Main runner T15 	593513	15 x 3700 x 38
Cross tee T15 	593507 593510	15 x 600 x 38 15 x 1200 x 38
Cross tee T40 (galvanized) 	316299 316297	40 x 600 x 38 40 x 1200 x 38
Wall angle type MIE2024 	434023	20 x 3000 x 24
Shadow line trim type MS15 	316335	15+15x3000/8+25
Outside corner for wall angle 	109100	for 24 mm Wall angle
Inside corner for wall angle 	109102	for 24 mm Wall angle
Outside corner for wall angle 	316310	for 15 mm Shadow line trim
Inside corner for wall angle 	316312	for 15 mm Shadow line trim
Wall profile 	316346	32 x 3000 x 41
Adjustable hanger The size specification indicates the min. and max. range 	469861 469868 469872 469876 469878 469880 469881	165 - 280 315 - 580 510 - 970 630 - 1210 755 - 1460 900 - 1750 1020 - 1990
Hold down clip 	430744	-
Hanger clip 	198242	-
Lamp hanger 	198896	-
Repair kit White paint for pre-painted tiles 	198956	- 100 mm NCS 0700

DANOPOR

Extra sound absorption and reduction as backing.
Mineral wool backing sealed in plastic bags.
No risk of dust particles.

SIZES

600 x 600 x 25 mm
600 x 600 x 50 mm



PLUGS

Plug for Belgravía w/24 mm T-profiles in wall angle 434023
SAP NO. 430801

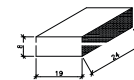

8x19x24 mm

Plug for Belgravía w/24 mm T-profiles in wall angle 316335
SAP NO. 430864

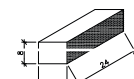

8x10,5x24 mm

Plug for Belgravía w/15 mm T-profiles in wall angle 434023
SAP NO. 430859

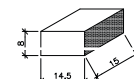

8x14,5x15 mm

Plug for Belgravía w/15 mm T-profiles in wall angle 316335
SAP NO. 430863

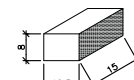

8x10,5x15 mm

DID YOU KNOW THAT ...

the cardboard in gypsum boards is produced of 100% recycled cellulose kept together by natural starch agents?

MARKANT

ACOUSTIC CEILING TILES

Recessed grid look with strong shading. Classic and highly robust acoustic ceiling. Exceptionally easy to install and demount.

ACOUSTIC CEILING TILES

MARKANT

SIZES

600 x 600 x 12,5 mm

625 x 625 x 12,5 mm

SURFACE

Standard white painted surface (closest match RAL 9003, gloss 5). Other colours available on request.

DANISH INDOOR CLIMATE LABELLING (DIM)

Indoor value: 10 days. Particle emission: low (< 0.75 mg)

CLEANING

Dust is removed using a dry duster or vacuum cleaner. Marks can be removed with a damp cloth using normal cleaning practices and neutral cleaning solutions.

AMBIENT CONDITIONS

The product is designed to perform under normal conditions of use. Tested at 90% RH and 30°C. The product can withstand ambient temperatures of up to 50°C.

LIGHT REFLECTION

Globe: 72.8%

Quadril: 75.1%

Micro: 72.1%

Regula: 82.6%

LOAD-BEARING CAPACITY

1 / A / No load	600 x 600 625 x 625	Globe, Quadril, Micro, Regula
2 / A / 30 N	600 x 600 625 x 625	Globe, Quadril, Micro, Regula
2 / B / No load	600 x 600 625 x 625	Globe, Quadril, Micro, Regula

FIRE CLASS

A2-s1,d0

ROBUSTNESS

Made of robust, glass fibre reinforced material with excellent pressure resistance. Under normal conditions of use, the product properties are preserved and there is no decomposition of material over time.

WEIGHT

Indicative tile weight: 9.45 – 10.20 kg/m².

All according to type of perforation and thickness.



CERTIFICATES

- Declaration of Conformity (EN 14190)
- Danish Indoor Climate Labelling

ACOUSTIC CEILING TILES MARKANT

ACOUSTICS

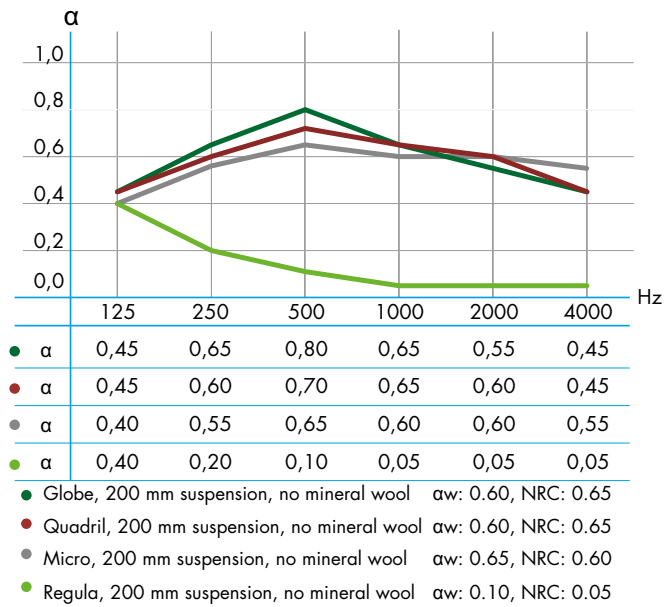

For acoustic data on alternative constructions please see "Absorption Data" at knaufdanoline.com

EDGES



Edge E
(tegular) / S15 or S24
Recessed grid
For Globe, Quadril and Micro.



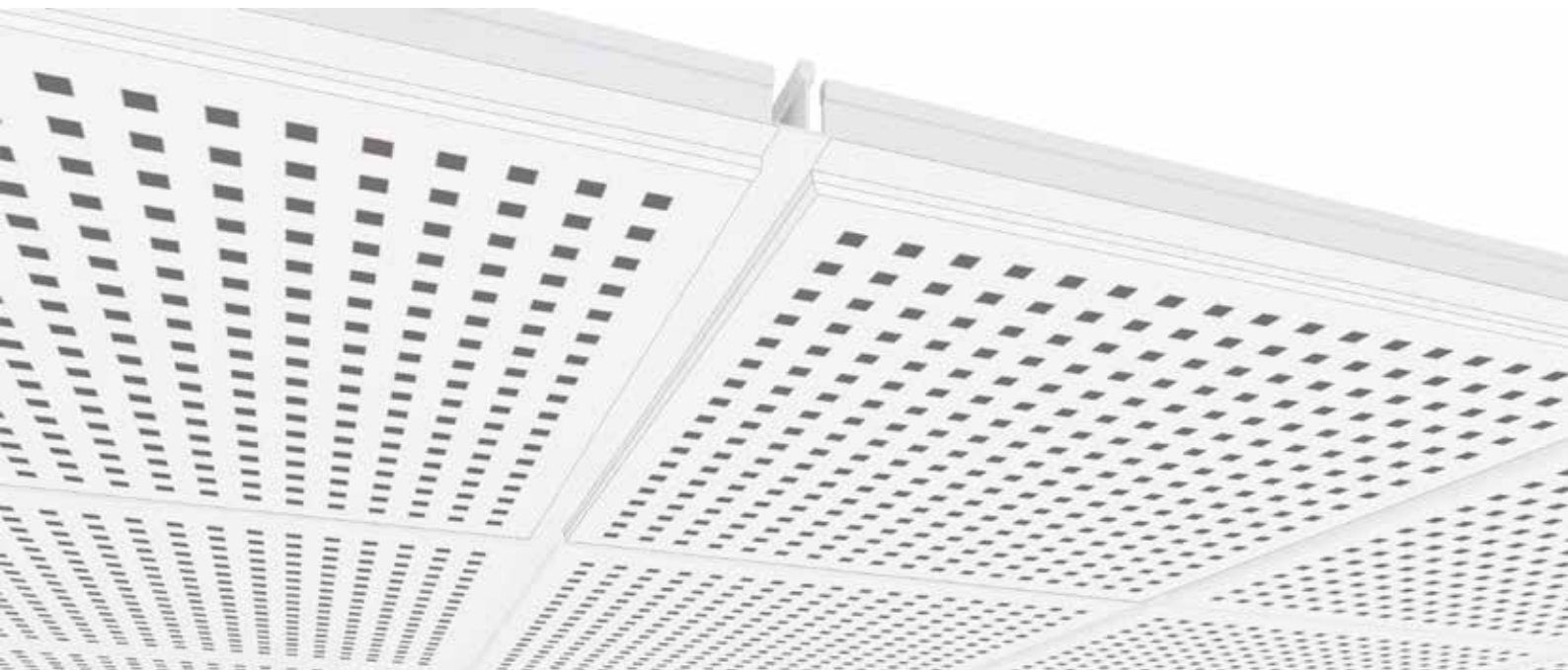

PERFORATION

Also available as Regula.

Other perforation patterns are manufactured to order.



Globe, Ø6 mm,
15 mm c/c
Perforation: 10.2%



Quadril, 12 x 12 mm,
30 mm c/c
Perforation: 13%



Micro, 3 x 3 mm,
8.3 mm c/c
Perforation: 10.2%

INSTALLATION GUIDE 600 x 600 mm module

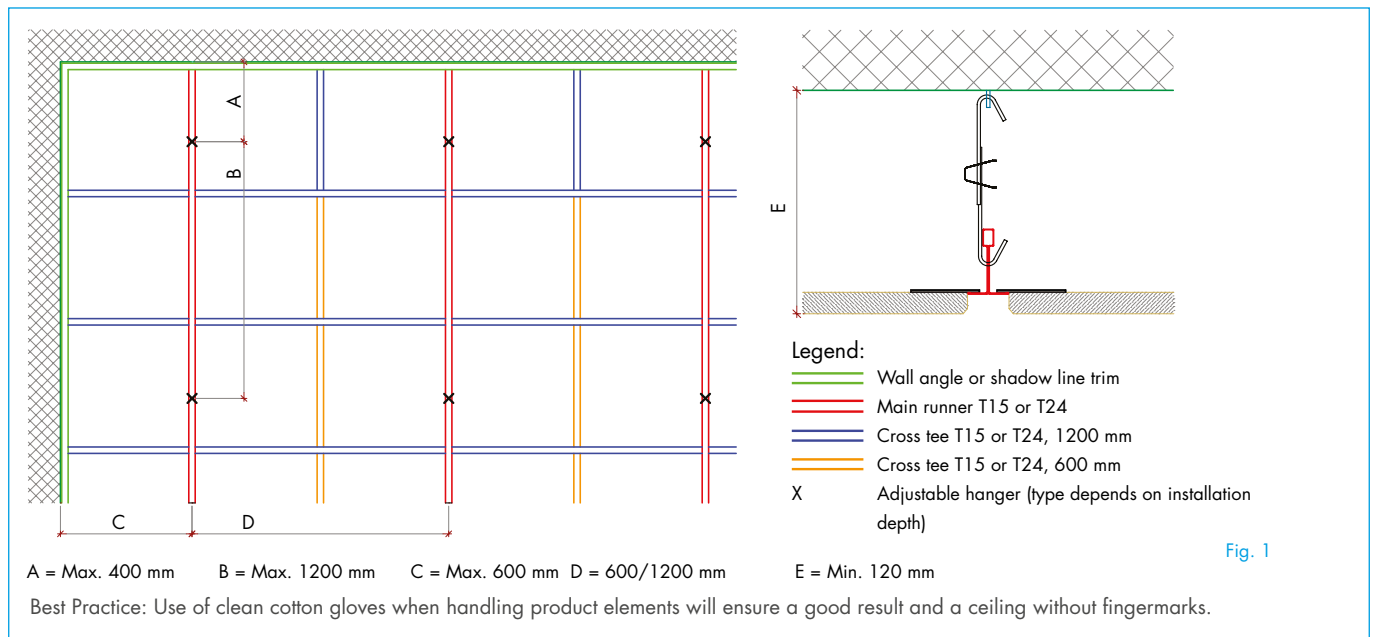
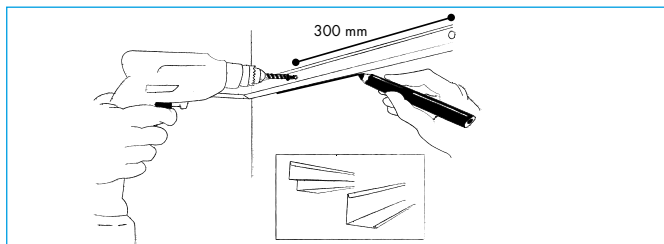
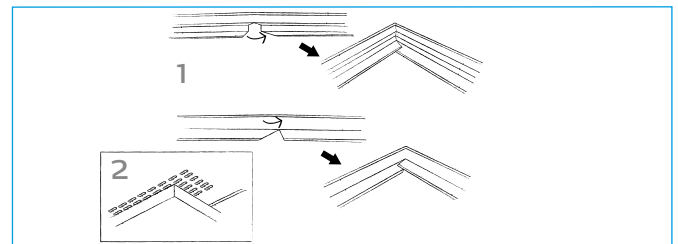

Fig. 1



MARKING AND WALL ANGLES

- Mark the location of the wall angles on the walls and columns in relation to the required ceiling height.
- Install the wall angles at max. 300 mm c/c. Choose the fixings in accordance with the substrate.



CORNERS

- Inside corners (1): cut the corners in a false mitre letting the ends overlap each other, unless anything to the contrary is specified. Finish with a corner cover, if necessary.
- Outside corners (2): must always be mitred. Finish with a corner cover if necessary.

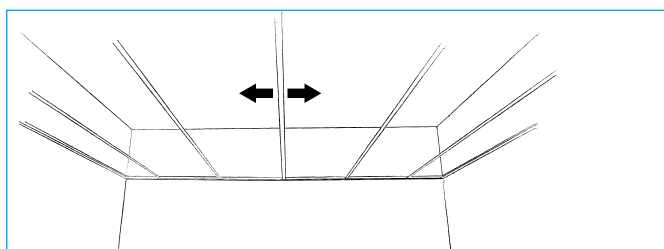

CEILING LAYOUT

- Divide the ceiling surface from the centre of the room or in accordance with the existing ceiling plans.
- The location of light fittings and ventilation units will have an influence on ceiling layout.
- Install the first main runner at max. 600 mm from the wall. The other main runners should be installed at 600/1200 mm c/c.

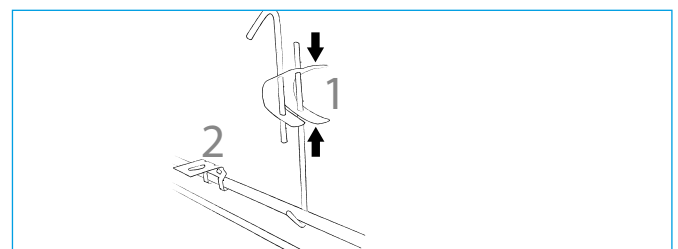

HANGERS

- Fix adjustable hangers (1) with eye screws or similar securely fastened to the primary construction.
- Direct hangers (2) are secured to the ceiling using appropriate fixings in accordance with the substrate.
- Install the first hanger at max. 400 mm from the wall. The other hangers should be installed at max. 1200 mm c/c.
- If loads from light fittings etc. are to be borne by the ceiling, install additional hangers.
- Refer to distances in figure 1.

INSTALLATION GUIDE 600 x 600 mm module

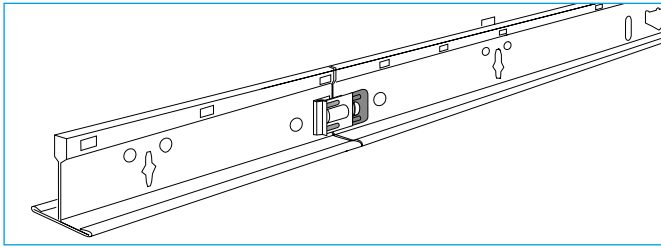

MAIN RUNNERS

- Install the main runners parallel to each other so that the slots are directly opposite each other.
- Join the main runners longitudinally by clicking them together.
- Adjust the lengths of the profiles with metal shears, a hacksaw or a circular power saw with a special blade.
- Make sure there is a hanger between the end joints of the main runners and the fire break.

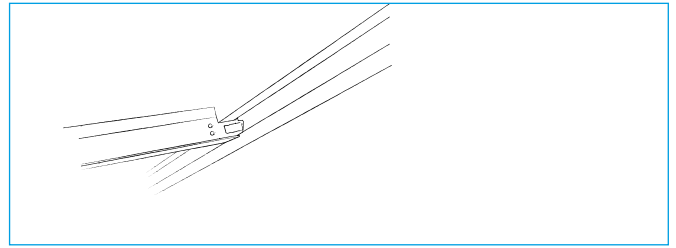

CROSS PROFILES

- Push the snap-in tongue into the slot on the main runner using light downward pressure.
- If there is a cross profile on the opposite side of the main runner, the new one must be on the left hand side of the one already in place.

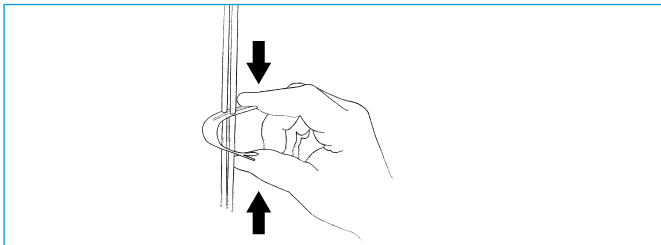

ADJUSTMENT

- Check that all profiles are correctly aligned when the entire suspension grid has been installed.
- Adjust the hangers so that they are taut and the ceiling surface is level.

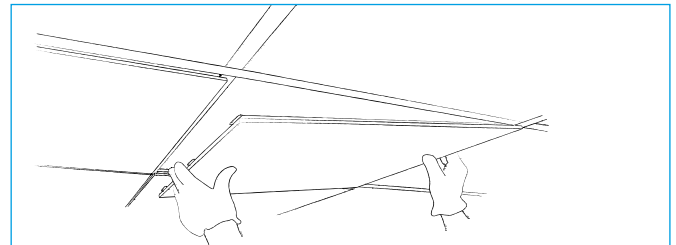

INSTALLATION

- Always wear clean cotton gloves when handling ceiling elements.
- Install the elements by tilting them up between the T-profiles.
- Check that all metal clips are resting on the main runners and that the edges of the tile are between the profiles so that the tile is locked in position.

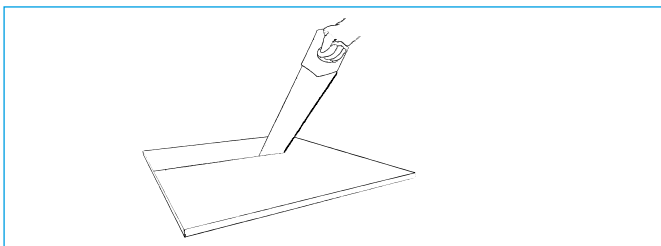

CUTTING

- Cut the elements to size from the front face with a fine-toothed saw.
- If metal clips are installed where the element is to be cut, they must be removed first.
- Grip the clip with a pair of pliers and twist it off gently.
- A new metal clip can be pressed into position with a clip mounting tool available from Knauf Danoline.

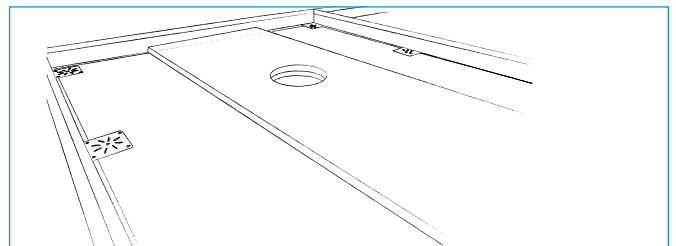

FIXTURES AND FITTINGS

- For sizes up to 625x625 not in Tangent and Unity perforations, units of up to 3kg can be installed directly into the panel without reinforcement.
- For larger module sizes and all sizes with Tangent perforation a reinforcement panel of sufficient strength can be installed behind the Markant element.
- The reinforcement panel must extend all the way into the main runners, so that the weight is transferred to them.
- The total weight should not be greater than 3kg for each m² of ceiling. Where loads are greater than 3kg/m², additional hangers must be used.
- Units over 3kg, should be installed independently, so that they do not place any load on the ceiling.

DETAILS

MARKANT IN GRID SYSTEM S15 OR S24 DIRECT TO WALL

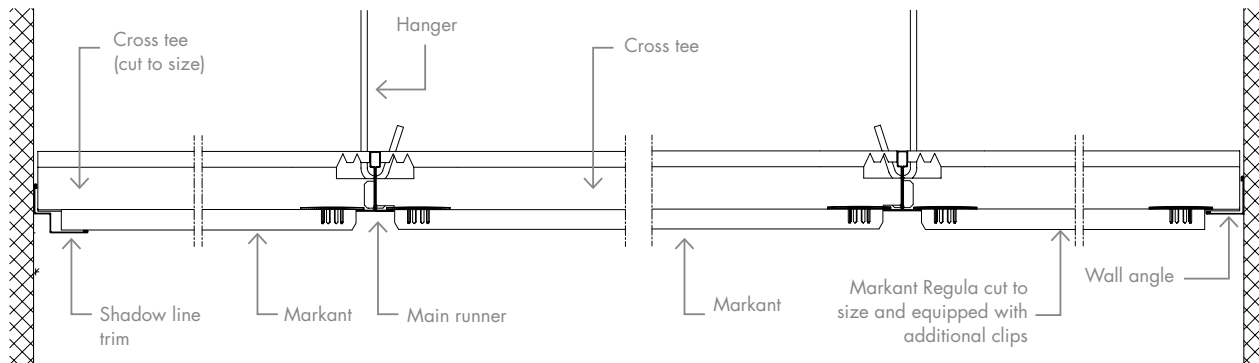

MARKANT IN GRID SYSTEM S15 OR S24 WITH PLAZA FRIEZE

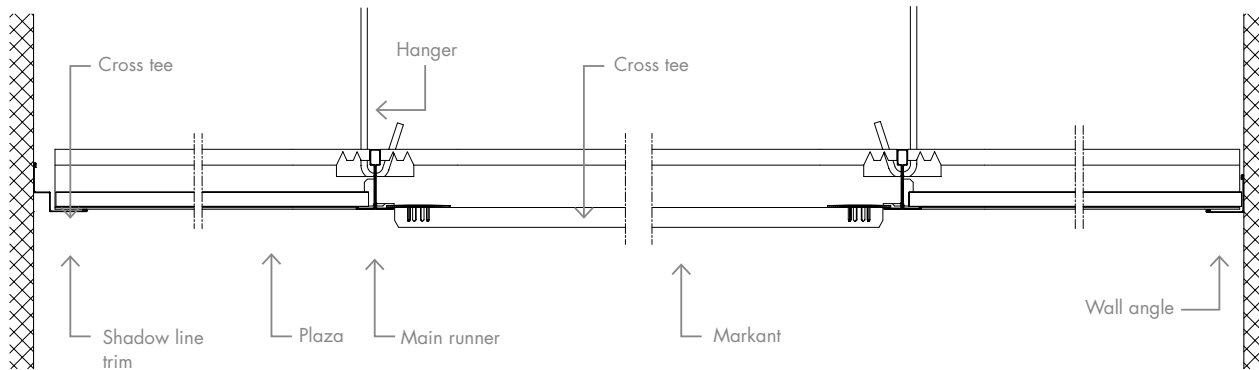



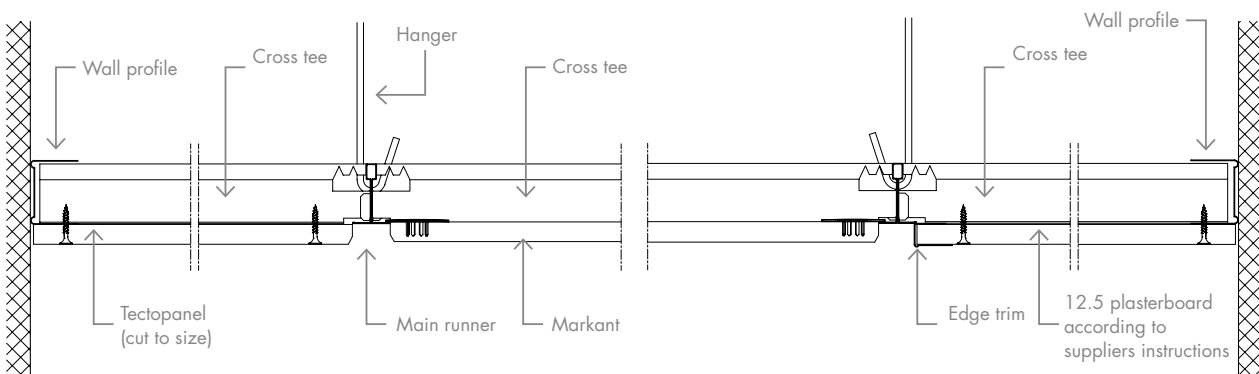



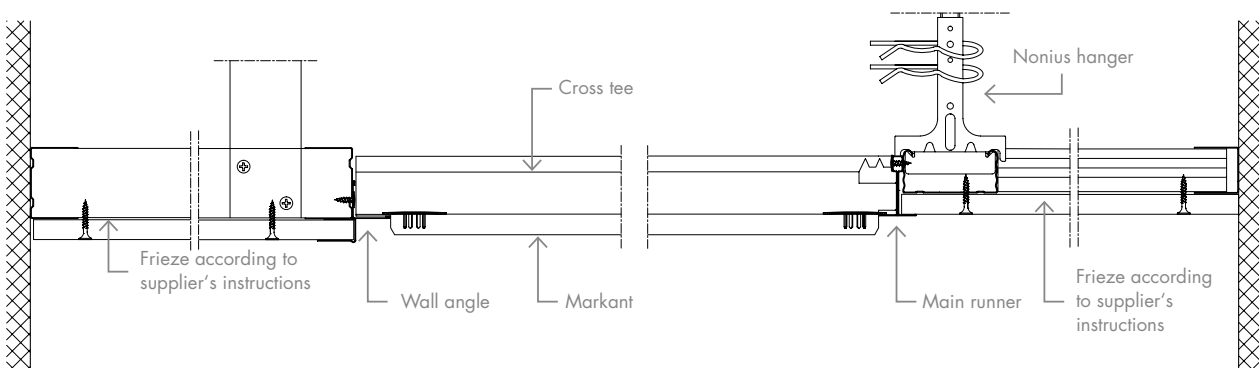

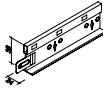
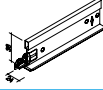
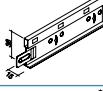
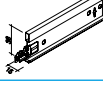
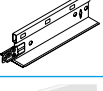

MARKANT IN GRID SYSTEM S15 OR S24 WITH FIXED FRIEZE ON T-PROFILES

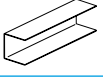
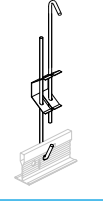

MARKANT IN GRID SYSTEM S15 OR S24 WITH ALTERNATIVE FRIEZE SOLUTIONS

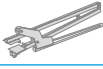
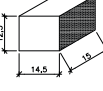

ACCESSORIES

PRODUCT NAME	SAP NO.	W x L x H (mm)
Main runner T24 	467385	24 x 3700 x 38
Cross tee T24 	467388 467389	24 x 600 x 38 24 x 1200 x 38
Main runner T15 	593513	15 x 3700 x 38
Cross tee T15 	593507 593510	15 x 600 x 38 15 x 1200 x 38
Cross tee T40 (galvanized) 	316299 316297	40 x 600 x 38 40 x 1200 x 38
Wall angle type MIE2024 	434023	20 x 3000 x 24
Shadow line trim type MS10 	316330	19+11x3000/13+19
Outside corner for wall angle 	109100 172920	for 24 mm Wall angle for 19 mm Wall angle
Inside corner for wall angle 	109102 172921	for 24 mm Wall angle for 19 mm Wall angle
Wall profile 	316346	32 x 3000 x 41
Adjustable hanger 	469861 469868 469872 469876 469878 469880 469881	165 - 280 315 - 580 510 - 970 630 - 1210 755 - 1460 900 - 1750 1020 - 1990
Hold-down clip (for Markant Swing) 	316313	-
Clips 	198364	40 x 40 1/11
Fixing tool for clips 	198353	-
Plug for Markant w/15 mm T-profiles in wall angle 434023 and shadow line trim 316330 	430861	12.5x14.5x15
Hold down clip 	113734	-
Hanger clip 	198242	-
Lamp hanger 	198896	-
Repair kit White paint for pre-painted tiles 	198956	100 mm NCS 0700

DANOPOR

Extra sound absorption and reduction as backing.
Mineral wool backing sealed in plastic bags.
No risk of dust particles.

SIZES

600 x 600 x 25 mm
600 x 600 x 50 mm



MARKANT SWING

Markant tiles are available with a special Swing function that facilitates the inspection work in the cavity. The demounted tiles are left suspended vertically during the inspection work.



DID YOU KNOW THAT ...

thanks to their robustness, perforated gypsum boards can be fully integrated with the wall construction, thereby creating a uniform wall surface with acoustic performance?

PLAZA

ACOUSTIC CEILING TILES

Functional design with a clean-cut look. Straight-forward acoustic ceiling with visible T-grid. Robust ceiling, easy to mount.

ACOUSTIC CEILING TILES

PLAZA

SIZES

600 x 600 x 9.5 mm*	600 x 1200 x 9.5 mm*
600 x 600 x 12.5 mm	600 x 1200 x 12.5 mm*
625 x 625 x 12.5 mm	625 x 1250 x 12.5 mm*

* Not available with Tangent and Unity perforation

SURFACE

Standard white painted surface (closest match RAL 9003, gloss 5). Other colours available on request

DANISH INDOOR CLIMATE LABELLING (DIM)

Indoor value: 10 days. Particle emission: low (< 0.75 mg)

CLEANING

Dust is removed using a dry duster or vacuum cleaner. Marks can be removed with a damp cloth using normal cleaning practices and neutral cleaning solutions.

AMBIENT CONDITIONS

The product is designed to perform under normal conditions of use. Tested at 90% RH and 30°C. The product can withstand ambient temperatures of up to 50°C.

LIGHT REFLECTION

Globe: 72.8%	Unity 3: 69.2%
Quadril: 75.1%	Unity 4: 72.5%
Micro: 72.1%	Unity 8 15 20: 72.2%
Tangent: 70.9%	Unity 9: 71.6%
Regula: 82.6%	

LOAD-BEARING CAPACITY

1 / A / No load	600 x 600 625 x 625	Globe, Quadril, Micro, Tangent, Regula, Unity 3, Unity 4, Unity 9 Unity 8 15 20
2 / A / No load	600 x 1200 625 x 1250	G1F, Q1F, M1F, R
2 / A / 30 N	600 x 600 625 x 625	Globe, Quadril, Micro, Regula
2 / B / No load	600 x 600 625 x 625	Globe, Quadril, Micro, Regula

FIRE CLASS

A2-s1,d0

ROBUSTNESS

Made of robust, glass fibre reinforced material with excellent pressure resistance. Under normal conditions of use, the product properties are preserved and there is no decomposition of material over time.

WEIGHT

Indicative tile weight: 7.80 – 8.70 (9.5 mm) / 9.00 – 9.90 (12.5 mm) kg/m². All according to type of perforation and thickness.



CERTIFICATES

- FDES LCA Declaration
- Declaration of Conformity (EN 14190)
- Danish Indoor Climate Labelling

ACOUSTIC CEILING TILES

PLAZA

ACOUSTICS

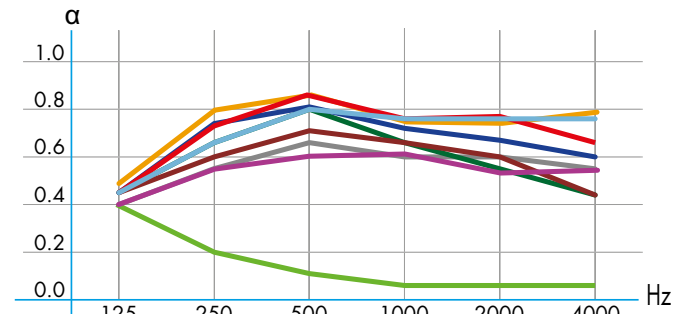

	125	250	500	1000	2000	4000
● α	0.45	0.65	0.80	0.65	0.55	0.45
● α	0.45	0.60	0.70	0.65	0.60	0.45
● α	0.40	0.55	0.65	0.60	0.60	0.55
● α	0.45	0.65	0.80	0.75	0.75	0.75
● α	0.50	0.80	0.85	0.75	0.75	0.80
● α	0.45	0.75	0.80	0.70	0.65	0.60
● α	0.40	0.55	0.60	0.60	0.50	0.50
● α	0.45	0.75	0.85	0.75	0.75	0.65
● α	0.40	0.20	0.10	0.05	0.05	0.05

- Globe, 200 mm suspension, no mineral wool αw: 0.60, NRC: 0.65
- Quadril, 200 mm suspension, no mineral wool αw: 0.60, NRC: 0.65
- Micro, 200 mm suspension, no mineral wool αw: 0.65, NRC: 0.60
- Tangent, 200 mm suspension, no mineral wool αw: 0.80, NRC: 0.75
- Unity 3, 200 mm suspension, no mineral wool αw: 0.80, NRC: 0.80
- Unity 4, 200 mm suspension, no mineral wool αw: 0.70, NRC: 0.75
- Unity 8 | 15 | 20, 200 mm suspension, no mineral wool αw: 0.60, NRC: 0.55
- Unity 9, 200 mm suspension, no mineral wool αw: 0.75, NRC: 0.80
- Regula, 200 mm suspension, no mineral wool αw: 0.10, NRC: 0.05

For acoustic data on alternative constructions please see "Absorption Data" at knaufdanoline.com

EDGES



Edge A
(SQUARE EDGE) / S15 or S24. Visible grid
For Globe, Quadril, Micro and Tangent

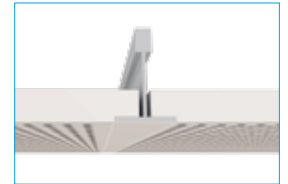

Edge A-Plus [A+]
S15 OR S24 Visible grid
For Unity 3, Unity 4, Unity 9 and U 8 | 15 | 20



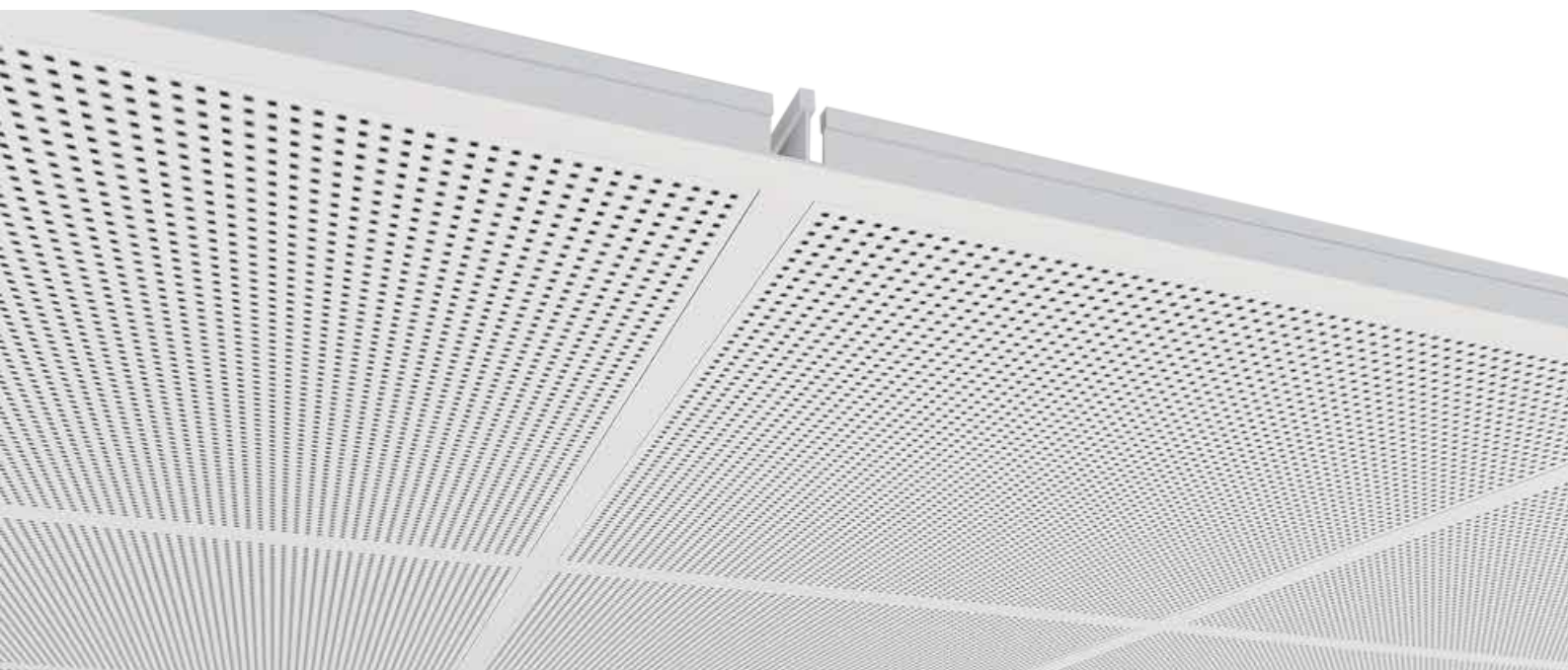

PERFORATION

Also available as Regula.

Other perforation patterns are manufactured to order.



Globe, Ø6 mm,
15 mm c/c
Perforation: 10.2%



Quadril, 12 x 12 mm,
30 mm c/c
Perforation: 13%



Micro, 3 x 3 mm,
8.3 mm c/c
Perforation: 10.2%



Tangent, 4 x 14 mm,
10/20 mm c/c
Perforation: 21.3%

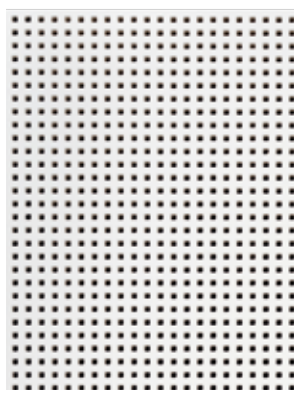

Unity 3, Ø3.5 mm,
8½ mm c/c
Perforation: 17.2%

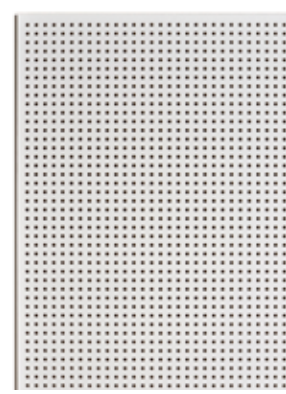

Unity 4, Ø4 mm,
10 mm c/c
Perforation: 12.2%



U8 | 15 | 20,
Ø8mm, Ø15 mm, Ø20 mm
Perforation: 10.8%

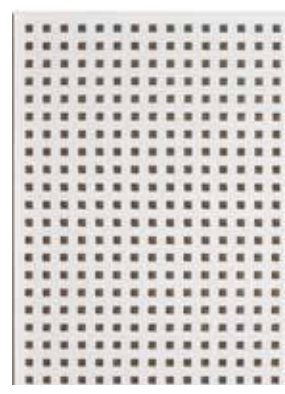

Unity 9, 9 x 9 mm,
20 mm c/c
Perforation: 18.9%

INSTALLATION GUIDE 600 x 600 mm module

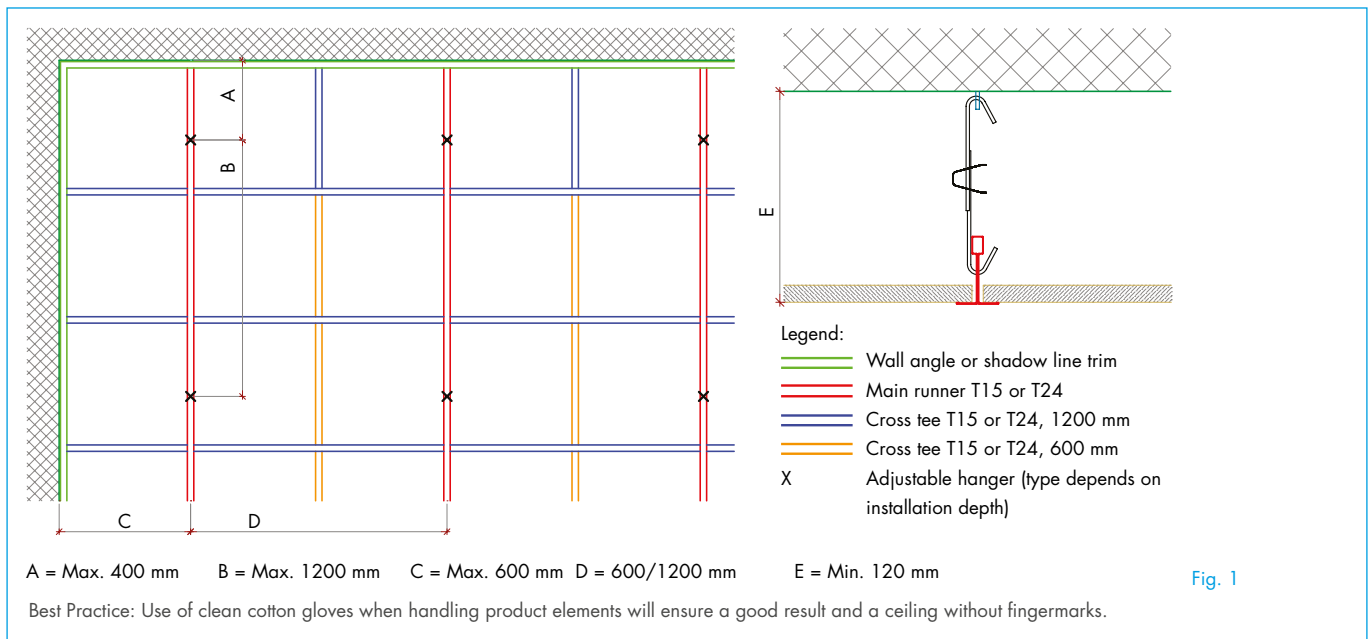
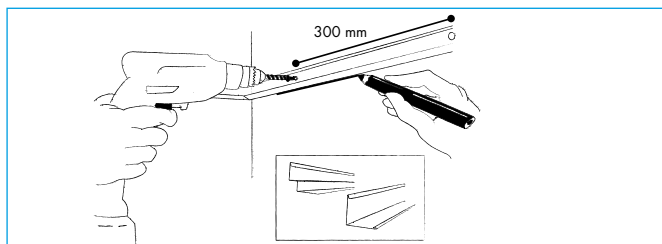
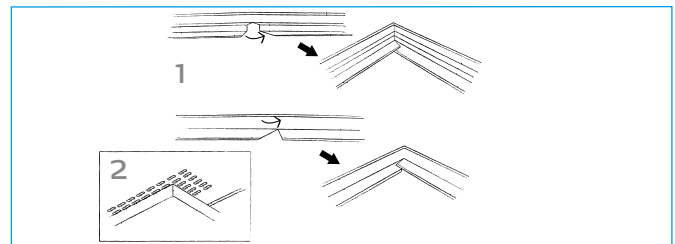

Fig. 1



MARKING AND WALL ANGLES

- Mark the location of the wall angles on the walls and columns in relation to the required ceiling height.
- Fix the wall angles at max. 300 mm c/c. Choose the fixings in accordance with the substrate.



CORNERS

- Inside corners (1): cut the corners in a false mitre letting the ends overlap each other, unless anything to the contrary is specified. Finish with a corner cover, if necessary.
- Outside corners (2): must always be mitred and finished with a corner cover if necessary.

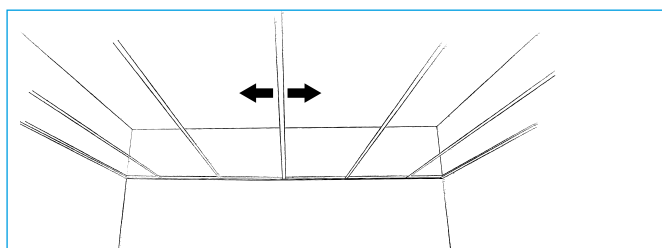

CEILING LAYOUT

- Divide the ceiling surface from the centre of the room or in accordance with the existing ceiling plans.
- The location of light fittings and ventilation units will have an influence on ceiling layout.
- The first main runner is installed at max. 600 mm from the wall. The other main runners should be installed at 600/1200 mm c/c.

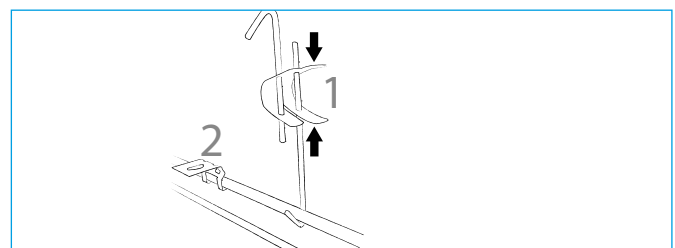

HANGERS

- Fix adjustable hangers (1) with eye screws or similar securely fastened to the primary construction.
- Direct hangers (2) are secured to the ceiling using appropriate fixings in accordance with the substrate.
- Install the first hanger at max. 400 mm from the wall. The other hangers should be installed at max. 1200 mm c/c.
- If loads from light fittings etc. are to be borne by the ceiling, install additional hangers.
- Refer to distances in figure 1.

INSTALLATION GUIDE 600 x 600 mm module

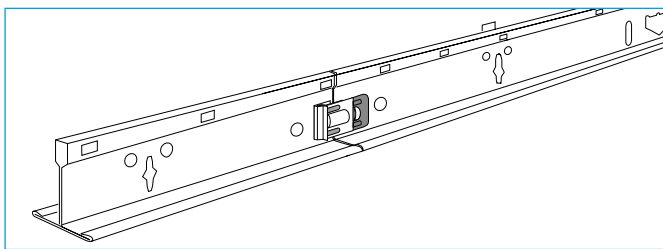

MAIN RUNNERS

- Install the main runners parallel to each other so that the slots are directly opposite each other.
- Join the main runners longitudinally by clicking them together.
- Adjust the lengths of the runners with metal shears, a hacksaw or a circular power saw with a special blade.
- Make sure there is a hanger between the end joints of the main runners and the fire break.

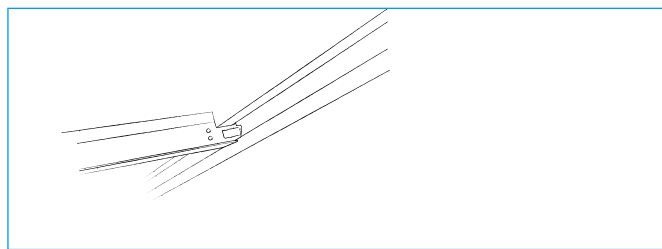

CROSS PROFILES

- Push the snap-in tongue into the slot on the main runner using light downward pressure.
- If there is a cross profile on the opposite side of the main runner, the new one must be on the left hand side of the one already in place.

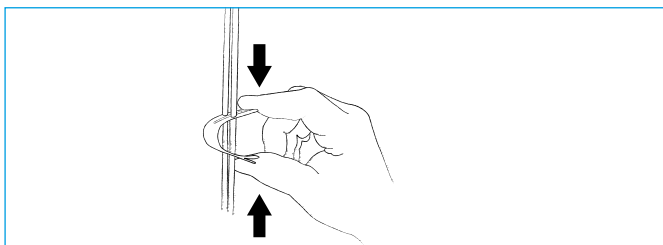

ADJUSTMENT

- Check that all profiles are correctly aligned when the entire suspension grid has been installed.
- Adjust the hangers so that they are taut and the ceiling surface is level.

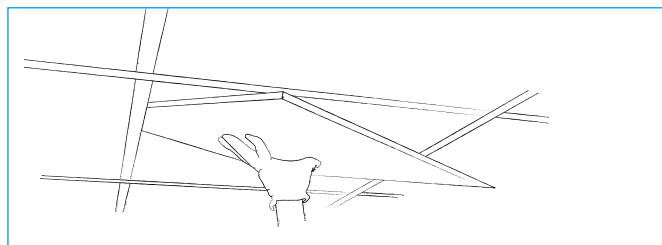

INSTALLATION

- Always wear clean cotton gloves when handling ceiling elements.
- Install the elements.

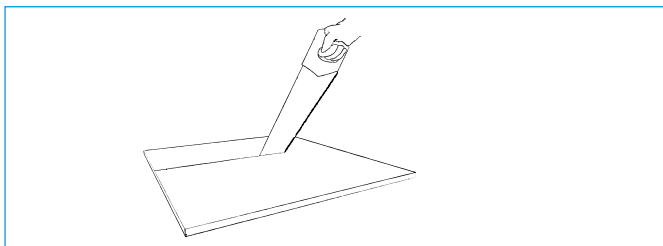

CUTTING

- Cut the elements to size from the front face.

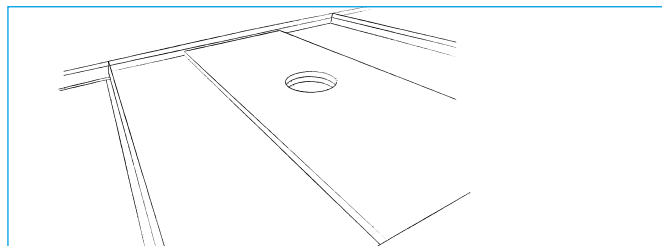

FIXTURES AND FITTINGS

- For sizes up to 625x625 not in Unity and Tangent perforation, units of up to 3kg can be installed directly into the panel without reinforcement.
- For larger module sizes and all sizes with Tangent perforation a reinforcement panel of sufficient strength can be installed behind the Plaza element.
- The reinforcement panel must extend all the way into the main runners, so that the weight is transferred to them.
- The total weight should not be greater than 3kg for each m² of ceiling. Where loads are greater than 3kg/m², additional hangers must be used.
- Units over 3kg, should be installed independently, so that they do not place any load on the ceiling.

DETAILS



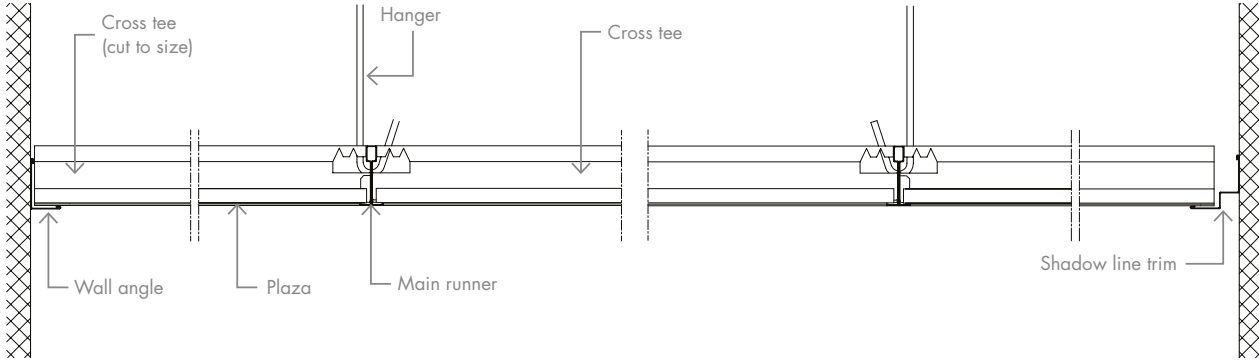

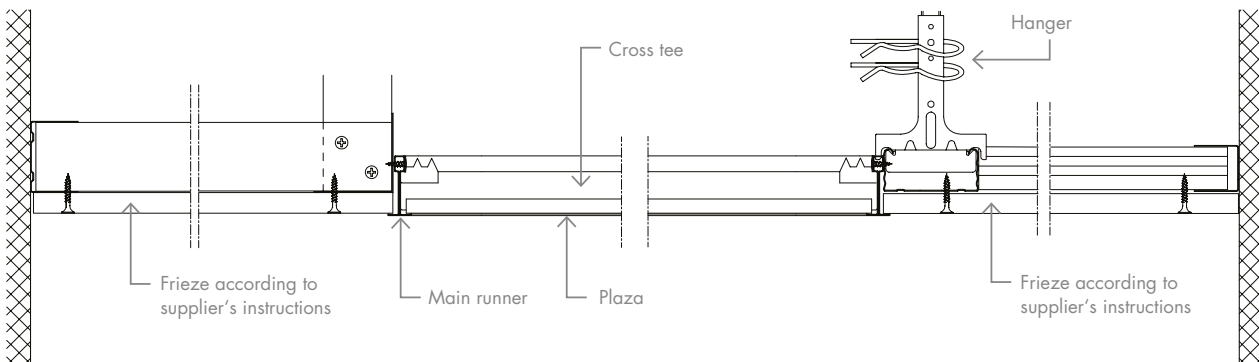
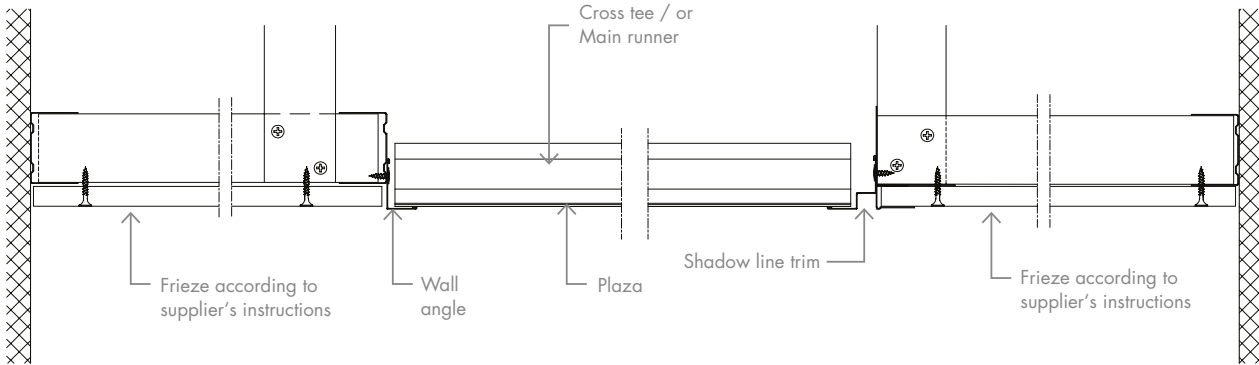

PLAZA IN GRID SYSTEM S15 OR S24 DIRECT TO WALL

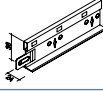
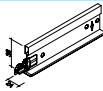
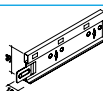
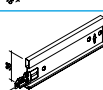
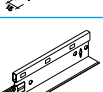

PLAZA IN GRID SYSTEM S15 OR S24 WITH FIXED FRIEZE

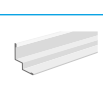
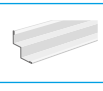
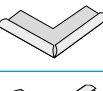
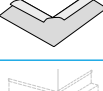
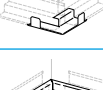
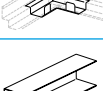
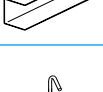
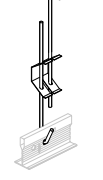
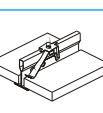

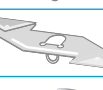
ACCESSORIES

PRODUCT NAME	SAP NO.	W x L x H (mm)
Main runner T24 	467385	24 x 3700 x 38
Cross tee T24 	467388 467389	24 x 600 x 38 24 x 1200 x 38
Main runner T15 	593513	15 x 3700 x 38
Cross tee T15 	593507 593510	15 x 600 x 38 15 x 1200 x 38
Cross tee T40 (galvanized) 	316299 316297	40 x 600 x 38 40 x 1200 x 38
Wall angle type MIE2024 	434023	20 x 3000 x 24
Shadow line trim type MS15 	316335	15+15x3000/8+25
Shadow line trim type MS10 	316330	19+11x3000/13+19
Outside corner for wall angle 	109100	for 24 mm Wall angle
Inside corner for wall angle 	109102	for 24 mm Wall angle
Outside corner for wall angle 	316310	for 15 mm Shadow line trim
Inside corner for wall angle 	316312	for 15 mm Shadow line trim
Wall profile 	316346	32 x 3000 x 41
Adjustable hanger The size specification indicates the min. and max. range 	469861 469868 469872 469876 469878 469880 469881	165 - 280 315 - 580 510 - 970 630 - 1210 755 - 1460 900 - 1750 1020 - 1990
Hold down clip 	430744	-
Hanger clip 	198242	-
Lamp hanger 	198896	-
Repair kit White paint for pre-painted tiles 	198956	100 mm NCS 0700

DANOPOR

Extra sound absorption and reduction as backing.

Mineral wool backing sealed in plastic bags.

No risk of dust particles.

SIZES

600 x 600 x 25 mm

600 x 600 x 50 mm



DID YOU KNOW THAT ...

gypsum boards are so robust that they can be curved even with small radii?

DANOTILE

ACOUSTIC CEILING TILES

Hygiene ceiling suitable for rooms with high cleaning and infection control requirements. White foil-covered surface with a clean-cut look. Robust ceiling tolerating tough cleaning and disinfection agents with pH levels from 2 – 13. Clean-room certified gypsum ceiling.

ACOUSTIC CEILING TILES

DANOTILE

SIZES

600 x 600 x 6.5 mm
 600 x 1200 x 6.5 mm
 600 x 600 x 9.5 mm
 600 x 1200 x 9.5 mm
 625 x 625 x 9.5 mm
 600 x 600 x 12.5 mm
 600 x 1200 x 12.5 mm

SURFACE

Foil-covered with pre-impregnated, non-toxic white paper RAL 9016 (NCS S0300-N, gloss 10)
 Tested for chemical resistance in accordance with DIN 68 861, FIRA BS 3962 and NEMA LD-3-1991.

DANISH INDOOR CLIMATE LABELLING (DIM)

Indoor value: 10 days. Particle emission: low (< 0.75 mg)

CLEANING

Dust is removed using a dry duster or vacuum cleaner. Marks can be removed with a damp cloth using normal cleaning practices and neutral cleaning solutions.

AMBIENT CONDITIONS

The product is designed to perform under normal conditions of use. Tested at 90% RH and 30°C. The product can withstand ambient temperatures of up to 50°C.

LIGHT REFLECTION

86.3%

LOAD-BEARING CAPACITY

2 / A / No load	600 x 1200 x 6.5
1 / B / No Load	600 x 600 x 9.5 625 x 625 x 9.5
2 / B / 30N	600 x 600 x 9.5 625 x 625 x 9.5

FIRE CLASS

B-s1,d0

FIRE RESISTANCE

½ hour fire resistance (6.5 mm)

ROBUSTNESS

Durable and dirt resistant surface. Product made of robust, glass fibre reinforced material with excellent pressure resistance. Under normal conditions of use, the product properties are preserved and there is no decomposition of material over time.

WEIGHT

Indicative tile weight: 6.90 – 7.90 kg/m². All according to thickness.



CERTIFICATES

- Clean room certificate (Céra Labo report)
- Physical resistance to disinfectants (Céra Labo report)
- Excell Hygiene Certificate
- FDES LCA Declaration
- Declaration of Conformity (EN 14190)
- Danish Indoor Climate Labelling

ACOUSTIC CEILING TILES

DANOTILE

ACOUSTICS

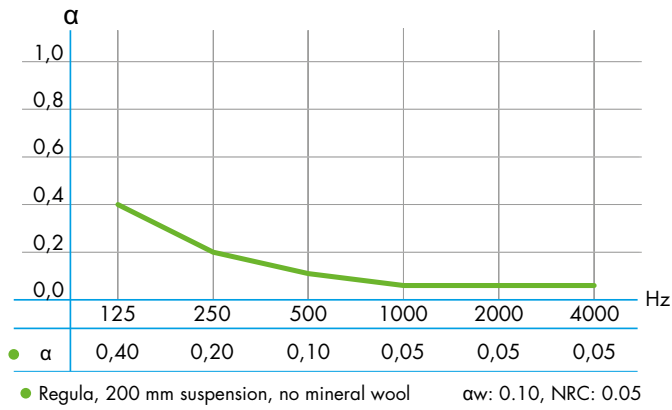

For acoustic data on alternative constructions please see "Absorption Data" at knaufdanoline.com

HYGIENE

Danotile can stand rigorous cleaning with concentrated disinfectants and detergents with a very high pH (up to pH 13.0) and a very low pH (down to pH 2.5). Danotile has also been tested for airborne particles in accordance with ISO 14644-1 and are classified as ISO 5.

EDGES



Edge A
(SQUARE EDGE) / S15 or S24
Visible grid
For Regula





PERFORATION

Available only as Regula.



INSTALLATION GUIDE 600 x 600 mm module

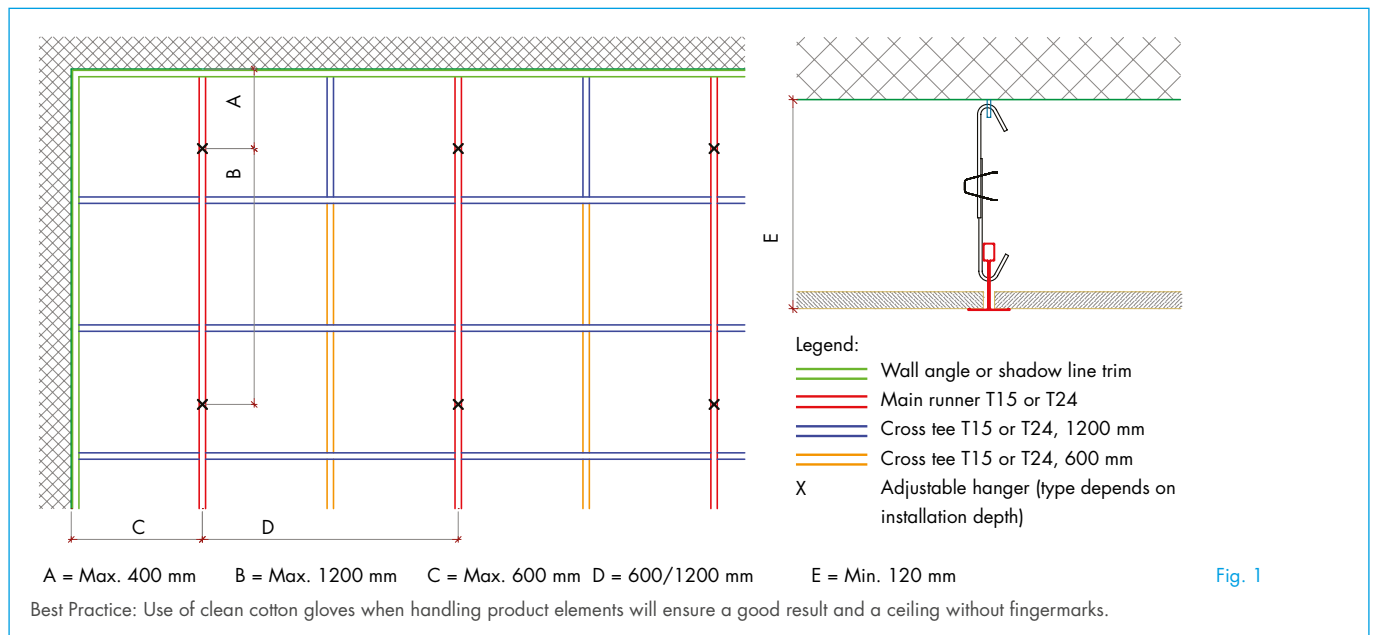
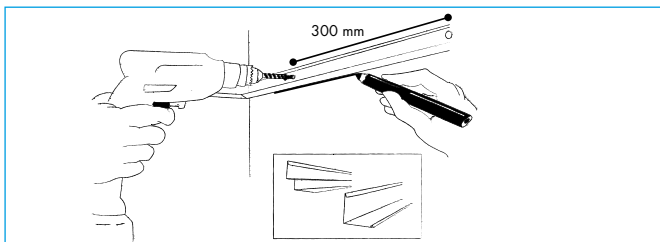
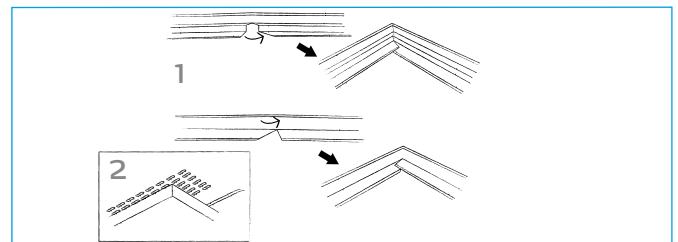

Fig. 1



MARKING AND WALL ANGLES

- Mark the location of the wall angles on the walls and columns in relation to the required ceiling height.
- Fix the wall angles at max. 300 mm c/c. Choose the fixings in accordance with the substrate.



CORNERS

- Inside corners (1): cut the corners in a false mitre letting the ends overlap each other, unless anything to the contrary is specified. Finish with a corner cover, if necessary.
- Outside corners (2): must always be mitred and finished with a corner cover if necessary.

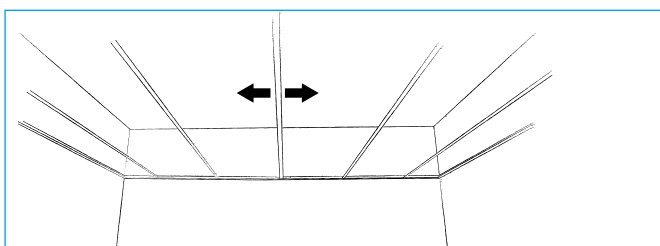

CEILING LAYOUT

- Divide the ceiling surface from the centre of the room or in accordance with the existing ceiling plans.
- The location of light fittings and ventilation units will have an influence on ceiling layout.
- The first main runner is installed at max. 600 mm from the wall. The other main runners should be installed at 600/1200 mm c/c.

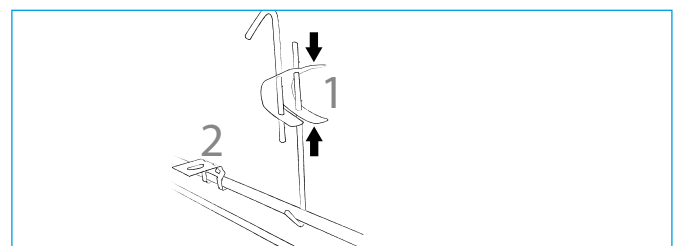

HANGERS

- Fix adjustable hangers (1) with eye screws or similar securely fastened to the primary construction.
- Direct hangers (2) are secured to the ceiling using appropriate fixings in accordance with the substrate.
- Install the first hanger at max. 400 mm from the wall. The other hangers should be installed at max. 1200 mm c/c.
- If loads from light fittings etc. are to be borne by the ceiling, install additional hangers.
- Refer to distances in figure 1.

INSTALLATION GUIDE 600 x 600 mm module

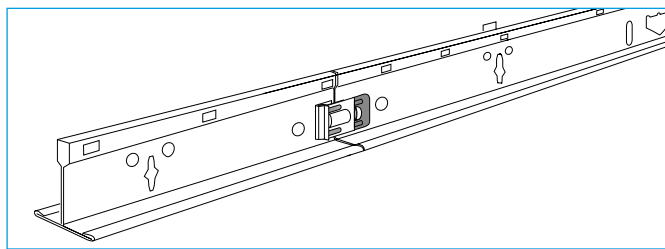

MAIN RUNNERS

- Install the main runners parallel to each other so that the slots are directly opposite each other.
- Join the main runners longitudinally by clicking them together.
- Adjust the lengths of the runners with metal shears, a hacksaw or a circular power saw with a special blade.
- Make sure there is a hanger between the end joints of the main runners and the fire break.

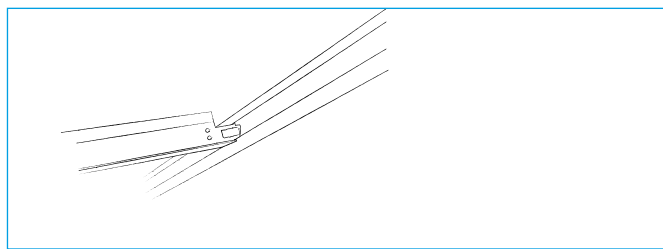

CROSS PROFILES

- Push the snap-in tongue into the slot on the main runner using light downward pressure.
- If there is a cross profile on the opposite side of the main runner, the new one must be on the left hand side of the one already in place.

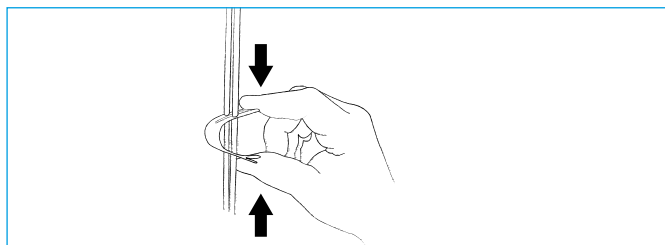

ADJUSTMENT

- Check that all profiles are correctly aligned when the entire suspension grid has been installed.
- Adjust the hangers so that they are taut and the ceiling surface is level.

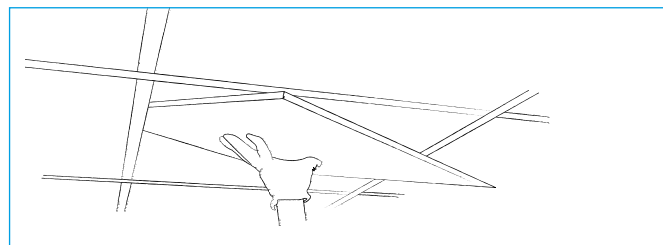

INSTALLATION

- Always wear clean cotton gloves when handling ceiling elements.
- Install the elements.

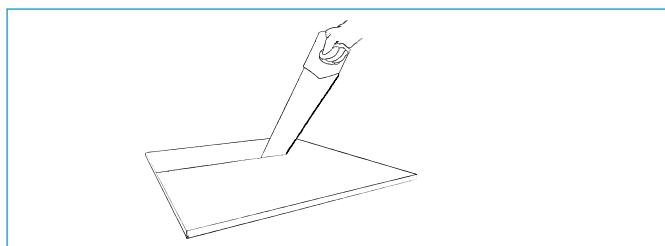

CUTTING

- Cut the elements to size from the front face.

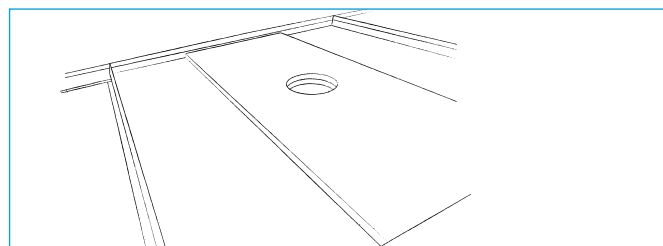

FIXTURES AND FITTINGS

- For sizes up to 625x625 and min. thickness 9mm, units of up to 3kg can be installed directly into the panel without reinforcement.
- For larger module sizes and all sizes in 6mm thickness, a reinforcement panel of sufficient strength can be installed behind the Danotile element.
- The reinforcement panel must extend all the way into the main runners, so that the weight is transferred to them.
- The total weight should not be greater than 3kg for each m² of ceiling. Where loads are greater than 3kg/m², additional hangers must be used.
- Units over 3kg, should be installed independently, so that they do not place any load on the ceiling.

DETAILS



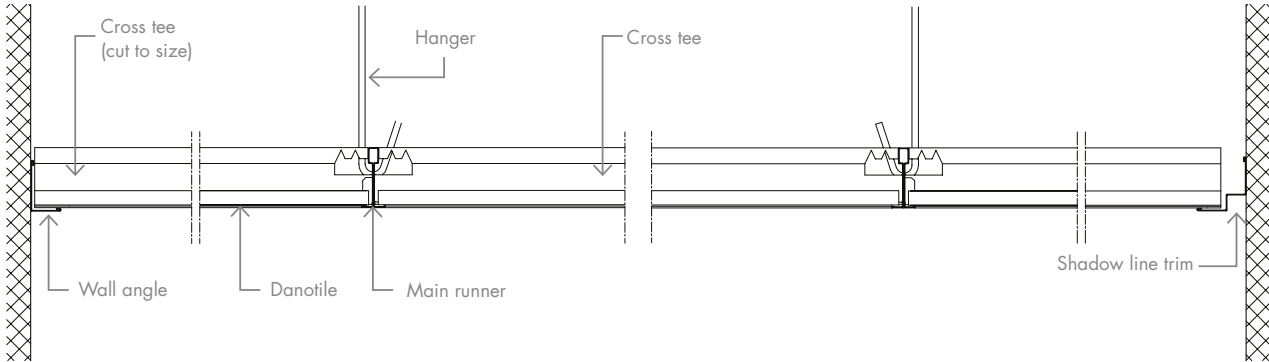



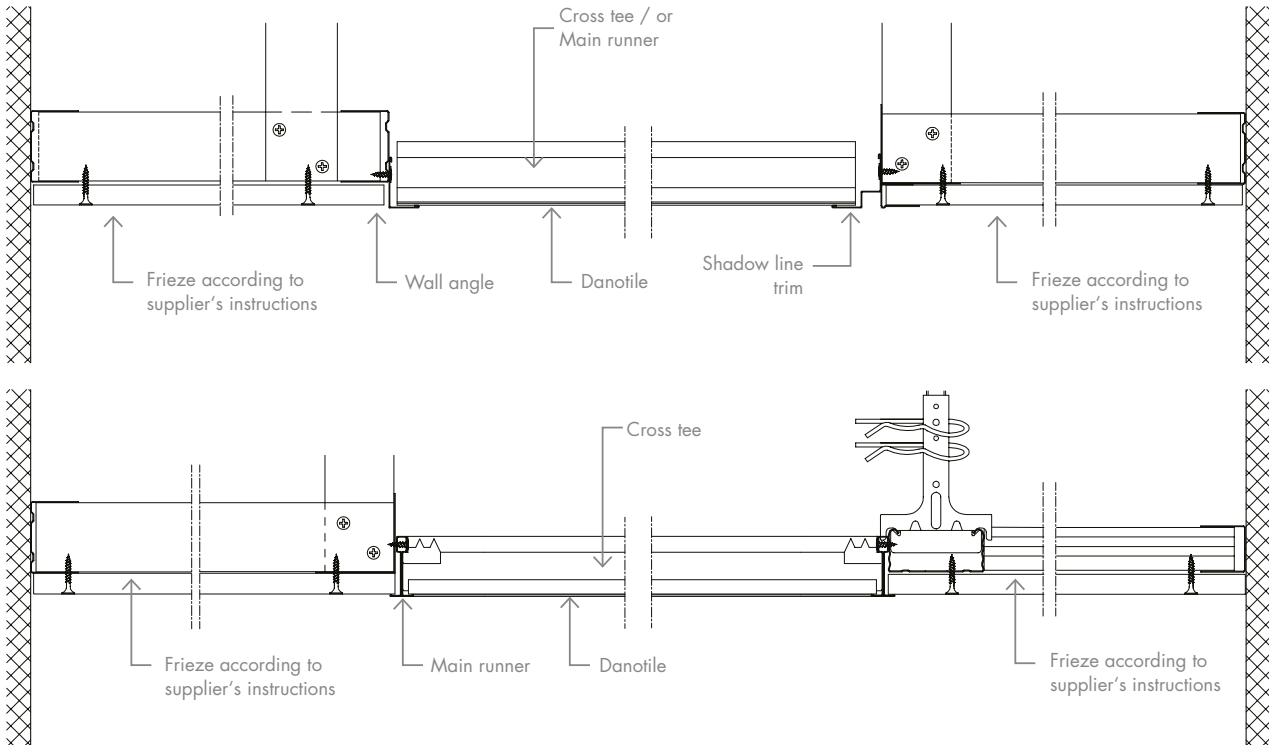

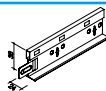
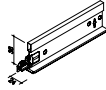
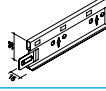
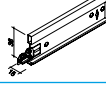

DANOTILE IN GRID SYSTEM S15 OR S24 DIRECT TO WALL



DANOTILE IN GRID SYSTEM S15 OR S24 WITH FIXED FRIEZE

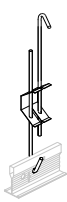
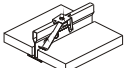

ACCESSORIES

PRODUCT NAME		SAP NO.	W x L x H (mm)
Main runner T24		467385	24 x 3700 x 38
Cross tee T24		467388 467389	24 x 600 x 38 24 x 1200 x 38
Main runner T15		593513	15 x 3700 x 38
Cross tee T15		593507 593510	15 x 600 x 38 15 x 1200 x 38
Wall angle type MIE2024		434023	20 x 3000 x 24
Shadow line trim type MS15		316335	15+15x3000/8+25
Shadow line trim type MS10		316330	19+11x3000/13+19
Outside corner for wall angle		109100	for 24 mm Wall angle
Inside corner for wall angle		109102	for 24 mm Wall angle
Outside corner for wall angle		316310	for 15 mm Shadow line trim
Inside corner for wall angle		316312	for 15 mm Shadow line trim
Adjustable hanger The size specification indicates the min. and max. range		469861 469868 469872 469876 469878 469880 469881	165 - 280 315 - 580 510 - 970 630 - 1210 755 - 1460 900 - 1750 1020 - 1990
Hold down clip		430744	-
Hanger clip		198242	-
Lamp hanger		198896	-



DID YOU KNOW THAT ...

gypsum used for manufacturing of Knauf Danoline products is high grade glass fibre reinforced?



MEDLEY

ACOUSTIC CEILING TILES

Demountable T-grid ceiling with a matt, dust proof foil surface. Robust ceiling that is easy to mount and clean.



ACOUSTIC CEILING TILES

MEDLEY

SIZES

600 x 600 x 9.5 mm

SURFACE

Foilcovered with pre-impregnated dyed foil (eggshell white).
Lightfastness ≥ 6 according to EN 15817.

DANISH INDOOR CLIMATE LABELLING (DIM)

Indoor value: 10 days. Particle emission: low (< 0.75 mg)

CLEANING

Dust is removed using a dry duster or vacuum cleaner. Marks can be removed with a damp cloth using normal cleaning practices and neutral cleaning solutions.

AMBIENT CONDITIONS

The product is designed to perform under normal conditions of use. Tested at 90% RH and 30°C. The product can withstand ambient temperatures of up to 50°C.

LIGHT REFLECTION

77.7%

LOAD-BEARING CAPACITY

2 / A / No load

2 / B / 30N

2 / B / No Load

FIRE CLASS

B-s1,d0

ROBUSTNESS

Durable and dirt resistant surface. Product made of robust, glass fibre reinforced material with excellent pressure resistance and can therefore be used on walls as well as ceilings. Under normal conditions of use, the product properties are preserved and there is no decomposition of material over time.

WEIGHT

Indicative tile weight: 8,10 – 8,70 kg/m².

All according to thickness.



CERTIFICATES

- FDES LCA Declaration
- Declaration of Conformity (EN 14190)
- Danish Indoor Climate Labelling

ACOUSTIC CEILING TILES

MEDLEY

ACOUSTICS

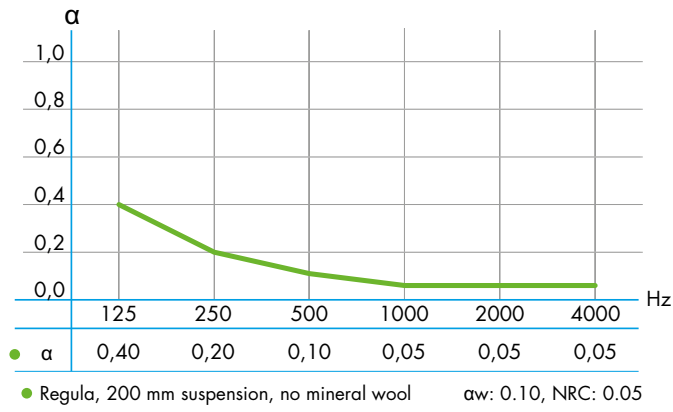

For acoustic data on alternative constructions please see "Absorption Data" at knaufdanoline.com

EDGES



Edge A
 (SQUARE EDGE) / S15 or S24
 Visible grid
 For Regula





PERFORATION

Available only as Regula.



INSTALLATION GUIDE 600 x 600 mm module

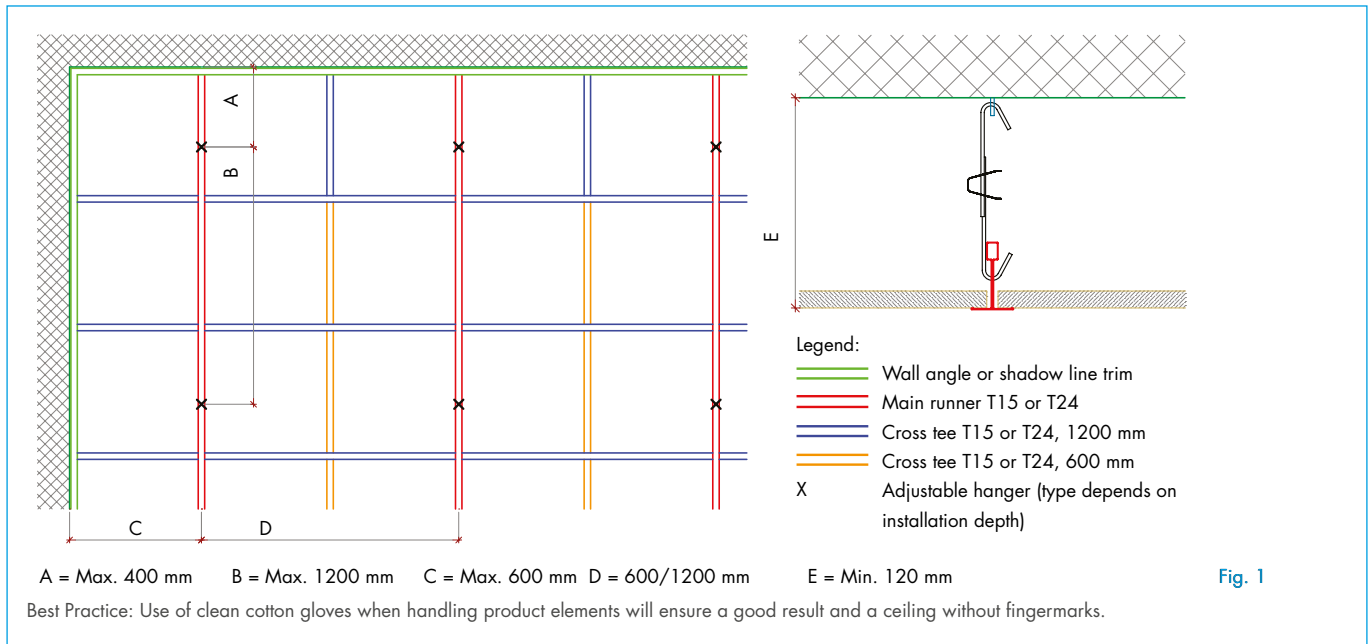
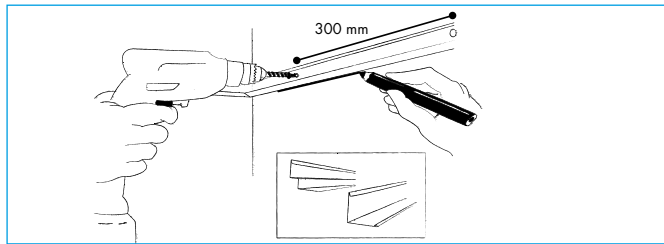
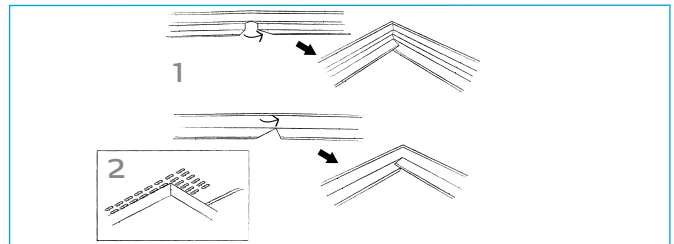

Fig. 1



MARKING AND WALL ANGLES

- Mark the location of the wall angles on the walls and columns in relation to the required ceiling height.
- Fix the wall angles at max. 300 mm c/c. Choose the fixings in accordance with the substrate.



CORNERS

- Inside corners (1): cut the corners in a false mitre letting the ends overlap each other, unless anything to the contrary is specified. Finish with a corner cover, if necessary.
- Outside corners (2): must always be mitred and finished with a corner cover if necessary.

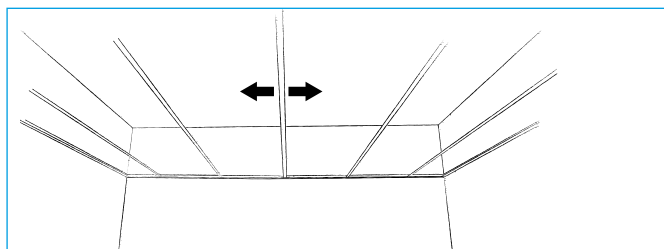

CEILING LAYOUT

- Divide the ceiling surface from the centre of the room or in accordance with the existing ceiling plans.
- The location of light fittings and ventilation units will have an influence on ceiling layout.
- The first main runner is installed at max. 600 mm from the wall. The other main runners should be installed at 600/1200 mm c/c.

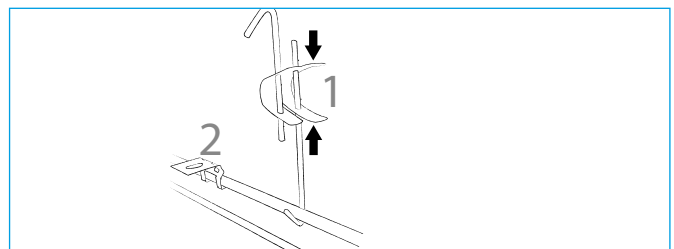

HANGERS

- Fix adjustable hangers (1) with eye screws or similar securely fastened to the primary construction.
- Direct hangers (2) are secured to the ceiling using appropriate fixings in accordance with the substrate.
- Install the first hanger at max. 400 mm from the wall. The other hangers should be installed at max. 1200 mm c/c.
- If loads from light fittings etc. are to be borne by the ceiling, install additional hangers.
- Refer to distances in figure 1.

INSTALLATION GUIDE 600 x 600 mm module

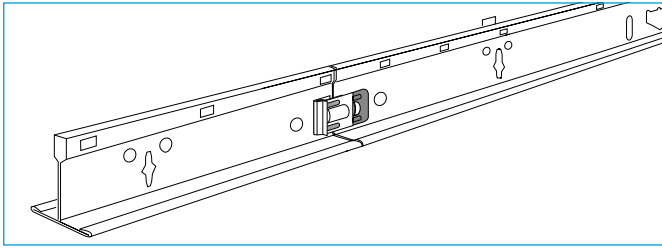

MAIN RUNNERS

- Install the main runners parallel to each other so that the slots are directly opposite each other.
- Join the main runners longitudinally by clicking them together.
- Adjust the lengths of the runners with metal shears, a hacksaw or a circular power saw with a special blade.
- Make sure there is a hanger between the end joints of the main runners and the fire break.

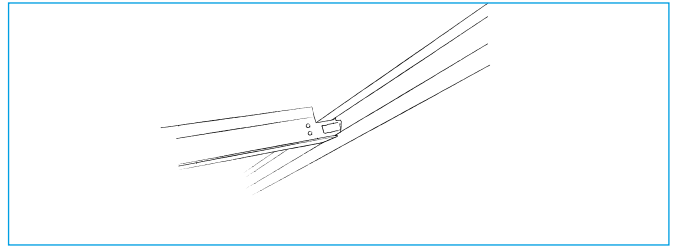

CROSS PROFILES

- Push the snap-in tongue into the slot on the main runner using light downward pressure.
- If there is a cross profile on the opposite side of the main runner, the new one must be on the left hand side of the one already in place.

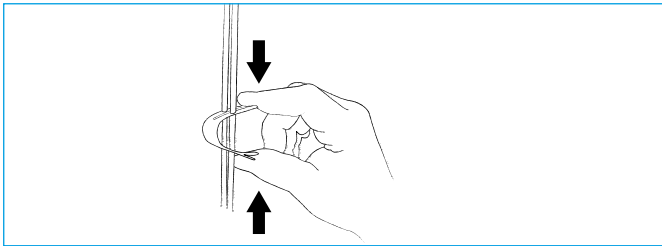

ADJUSTMENT

- Check that all profiles are correctly aligned when the entire suspension grid has been installed.
- Adjust the hangers so that they are taut and the ceiling surface is level.

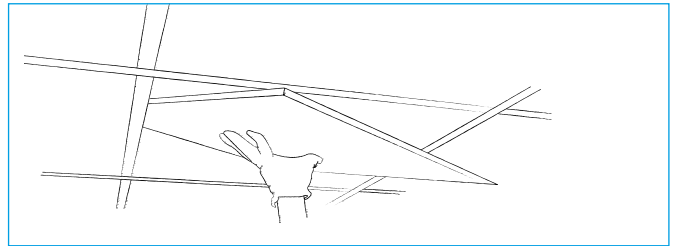

INSTALLATION

- Always wear clean cotton gloves when handling ceiling elements.
- Install the elements.

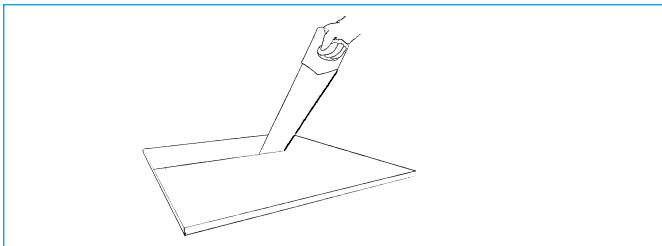

CUTTING

- Cut the elements to size from the front face.

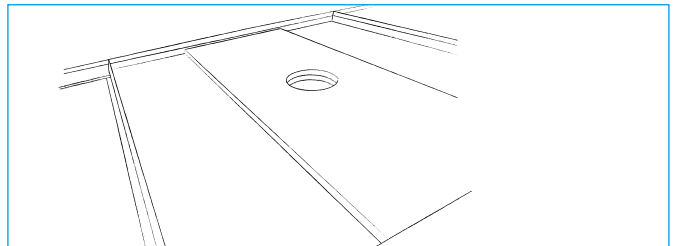

FIXTURES AND FITTINGS

- For sizes up to 625x625 and min. thickness 9mm, units of up to 3kg can be installed directly into the panel without reinforcement.
- For larger module sizes and all sizes in 6mm thickness, a reinforcement panel of sufficient strength can be installed behind the Medley element.
- The reinforcement panel must extend all the way into the main runners, so that the weight is transferred to them.
- The total weight should not be greater than 3kg for each m² of ceiling. Where loads are greater than 3kg/m², additional hangers must be used.
- Units over 3kg, should be installed independently, so that they do not place any load on the ceiling.

DETAILS



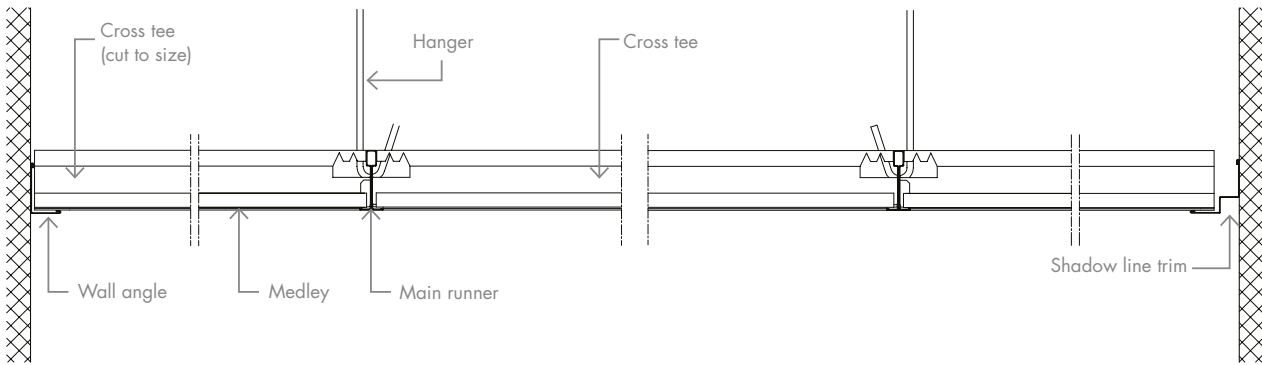



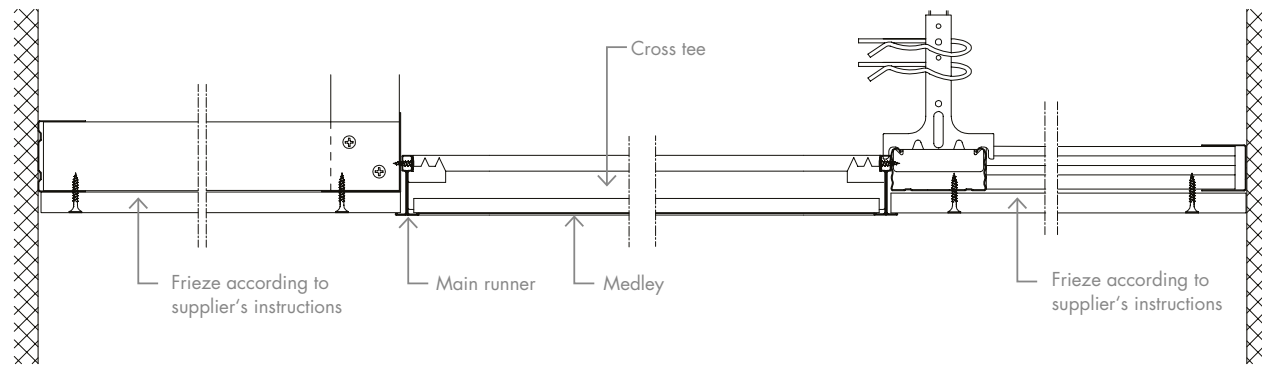
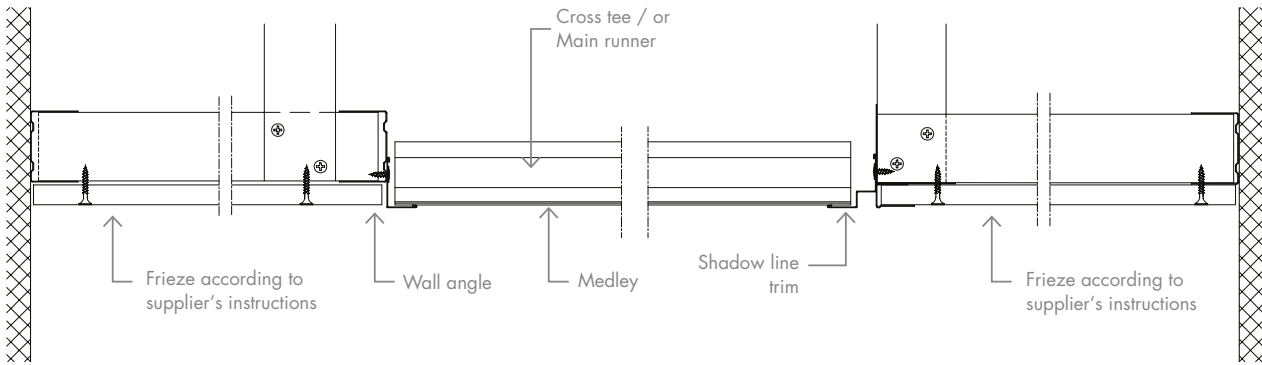

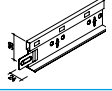
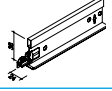
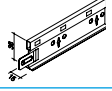
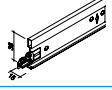

MEDLEY IN GRID SYSTEM S15 OR S24 DIRECT TO WALL

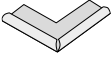

MEDLEY IN GRID SYSTEM S15 OR S24 WITH FIXED FRIEZE

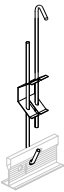
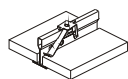

ACCESSORIES

PRODUCT NAME		SAP NO.	W x L x H (mm)
Main runner T24		467385	24 x 3700 x 38
Cross tee T24		467388 467389	24 x 600 x 38 24 x 1200 x 38
Main runner T15		593513	15 x 3700 x 38
Cross tee T15		593507 593510	15 x 600 x 38 15 x 1200 x 38
Wall angle type MIE2024		434023	20 x 3000 x 24
Shadow line trim type MS15		316335	15+15x3000/8+25
Shadow line trim type MS10		316330	19+11x3000/13+19
Outside corner for wall angle		109100 172920	for 24 mm Wall angle for 19 mm Wall angle
Inside corner for wall angle		109102 172921	for 24 mm Wall angle for 19 mm Wall angle
Outside corner for wall angle		316310	for 15 mm Shadow line trim
Inside corner for wall angle		316312	for 15 mm Shadow line trim
Adjustable hanger The size specification indicates the min. and max. range		469861 469868 469872 469876 469878 469880 469881	165 - 280 315 - 580 510 - 970 630 - 1210 755 - 1460 900 - 1750 1020 - 1990
Hold down clip		430744	-
Hanger clip		198242	-
Lamp hanger		198896	-

DID YOU KNOW THAT ...

synthetic (recycled industrial) gypsum has a higher purity than natural gypsum, typically 96% vs. 80%?

CORRIDOR 400

ACOUSTICAL PLANK CEILINGS

Distinct unified look for narrow rooms and corridors. No suspension runners and hangers required.

Open area with no hangers revealed when demounted during inspection work. Self-supporting up to 2.4 m.

ACOUSTICAL PLANK CEILINGS

CORRIDOR 400

SIZES

400 x 1200 x 9.5 mm
 400 x 1800 x 9.5 mm
 400 x 2400 x 9.5 mm
 400 x Special length (900 - 2400) x 9.5 mm

SURFACE

Standard white painted surface
 (closest match RAL 9003, gloss 5)
 Other colours available on request

DANISH INDOOR CLIMATE LABELLING (DIM)

Indoor value: 10 days
 Particle emission: low (< 0.75 mg)

CLEANING

Dust is removed using a dry duster or vacuum cleaner. Marks can be removed with a damp cloth using normal cleaning practices and neutral cleaning solutions.

AMBIENT CONDITIONS

The product is designed to perform under normal conditions of use. Tested at 90% RH and 30°C. The product can withstand ambient temperatures of up to 50°C.

LIGHT REFLECTION

Globe: 72.8%
 Quadril: 75.1%
 Micro: 72.1%
 Tangent: 70.9%
 Regula: 82.6%

LOAD-BEARING CAPACITY

G, Q, M, T, R: 1 / A / No load
 G, Q, M, R: 2 / A / 30N
 G, Q, M, T, R: 2 / B / No load

FIRE CLASS

A2-s1,d0

ROBUSTNESS

Made of robust, glass fibre reinforced material with excellent pressure resistance. Under normal conditions of use, the product properties are preserved and there is no decomposition of material over time.

WEIGHT

Indicative tile weight: 11.66 – 12.69 kg/m².
 All according to type of perforation.



CERTIFICATES

- Declaration of Conformity (EN 14190)
- Danish Indoor Climate Labelling

ACOUSTICAL PLANK CEILINGS

CORRIDOR 400

ACOUSTICS

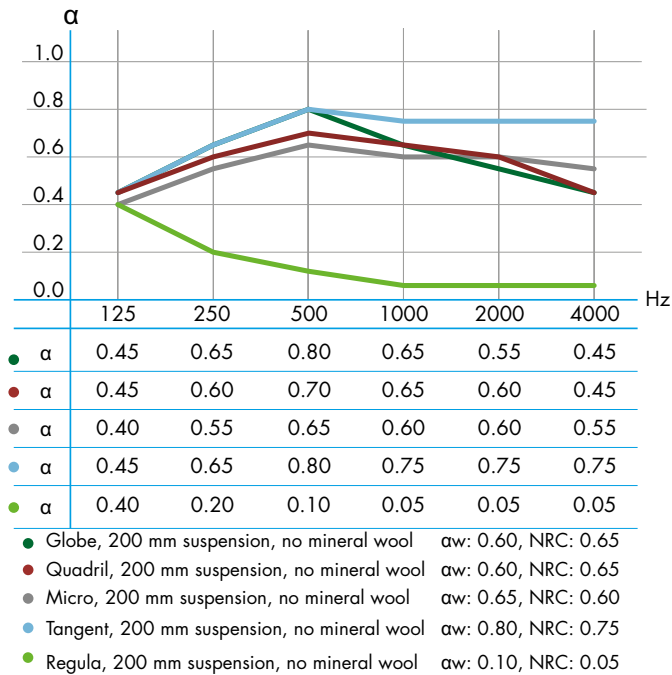

For acoustic data on alternative constructions please see "Absorption Data" at knaufdanoline.com

EDGES



Edge D

(rebated and grooved edge)
Self-supporting with visible trim at the short ends

For Globe, Quadril, Micro and Tangent





PERFORATION

Also available as Regula.

Other perforation patterns are manufactured to order.



Globe, Ø6 mm
15 mm c/c
Perforation: 10.6%



Quadril, 12 x 12 mm
30 mm c/c
Perforation: 14.2%



Micro, 3 x 3 mm
8.3 mm c/c
Perforation: 10.6%



Tangent, 4 x 14 mm
10/20 mm c/c
Perforation: 21.6%

INSTALLATION GUIDE

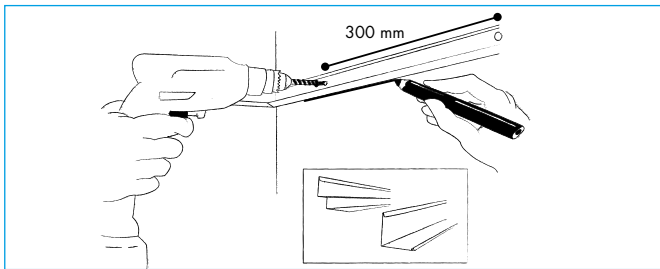
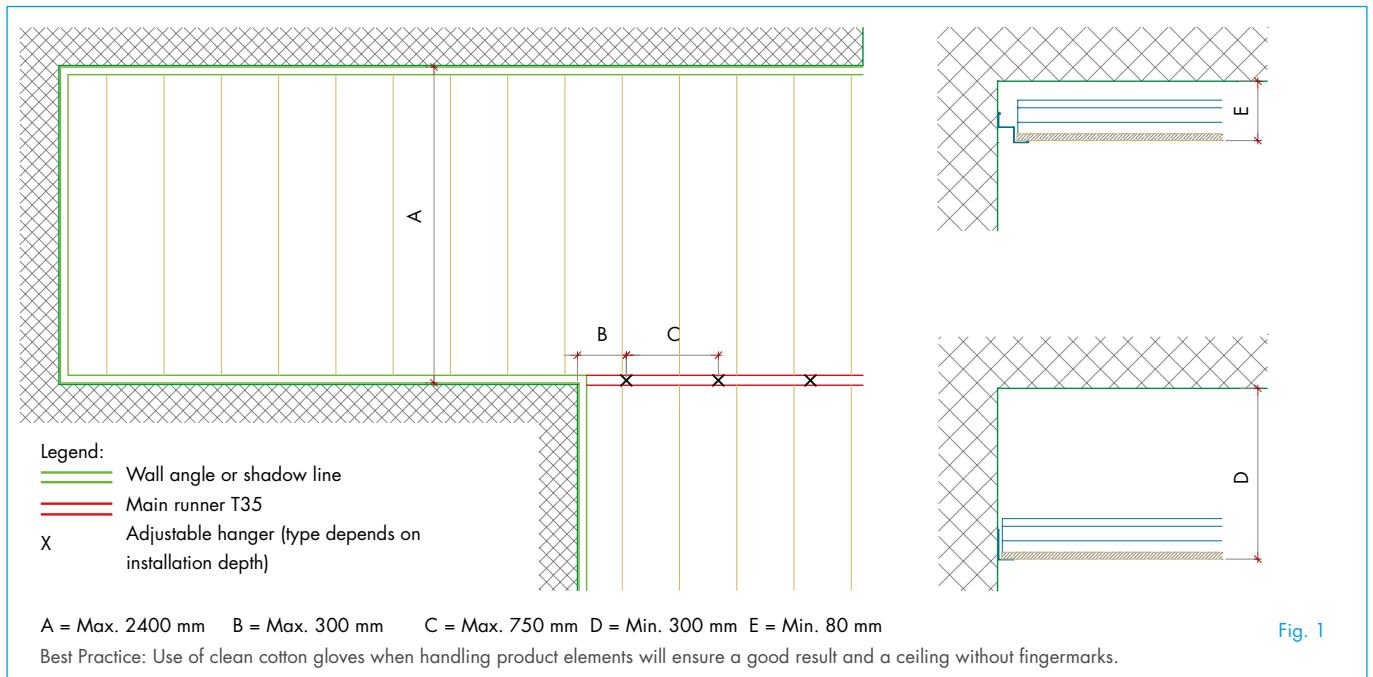

MARKING AND WALL ANGLES

- Mark the location of the wall angles on the walls and columns in relation to the required ceiling height.
- Install wall angle or shadow line trim at max. 300 mm. Choose fittings in accordance with the substrate.
- Please note that Corridor 400 requires heavy duty wall angles or shadow line trims with metal thickness of minimum 0.7 mm
- The bearing contact surface of the wall angle / shadow line trim must be at least 20 mm.

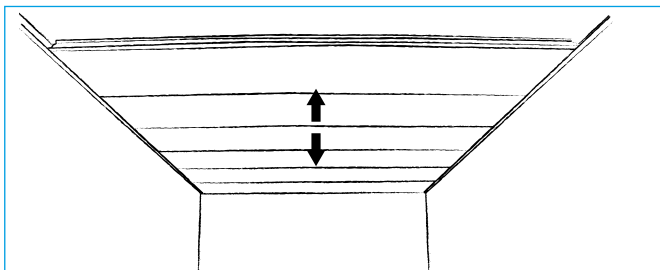

CEILING LAYOUT

- Divide the ceiling surface from the centre of the room or in accordance with the existing ceiling plans.

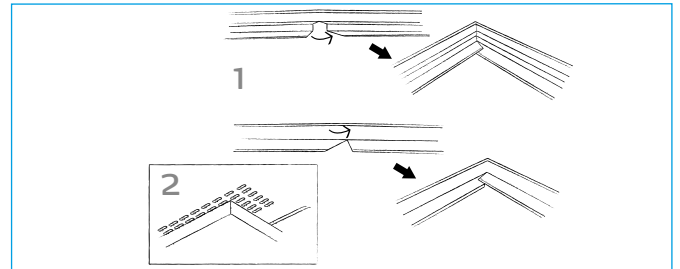

CORNERS

- Inside corners (1): cut the corners in a false mitre letting the ends overlap each other, unless anything to the contrary is specified.
- Outside corners (2): must always be mitred.

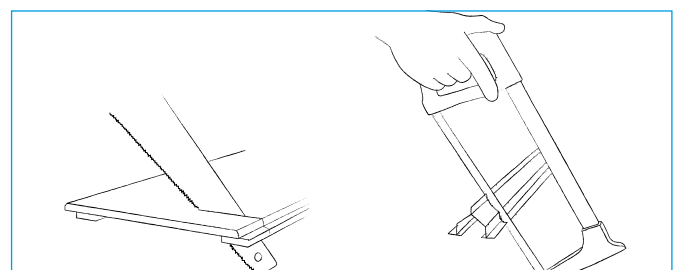

CUTTING

- Always wear clean cotton gloves when handling elements.
- Cut the elements to size from the front with a fine-toothed saw. Elements must be 3-8 mm undersized according to tight measure.
- Adjust the lengths of the profiles with a hacksaw or a circular power saw with a special blade, max. 10 mm shorter than the ceiling element.

INSTALLATION GUIDE

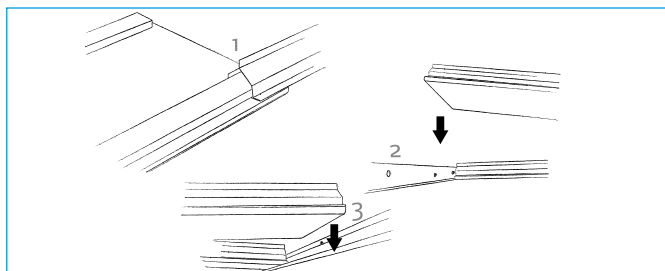

INSTALLATION

- Always wear clean cotton gloves when handling elements.
- Push the flex runner over the gypsum runner before installation (1).
- Place the elements in position on the wall angle and push them close together (2 and 3).
- Recommended minimum installation height: when using wall angles, 300 mm, when using shadow line trims, 85 mm.

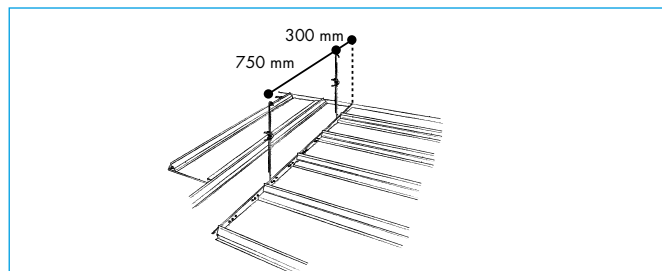

CHANGE OF DIRECTION AND NICHES

- Use Knauf Danoline T-profiles type T35 (35 mm wide) supported by hangers when changing directions and in connection with niches.
- Install the first hanger max. 300 mm from the wall. Other hangers should be installed at max. 750 mm c/c.

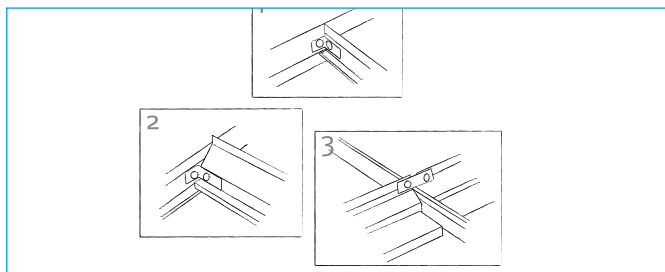

JOINING ELEMENTS IN T-PROFILES

- Secure the T-profile to the wall construction with an angle. (1)
- At least every 4th element resting on the T-profile should be secured against sliding using an angle or band iron at both ends. (2)(3)

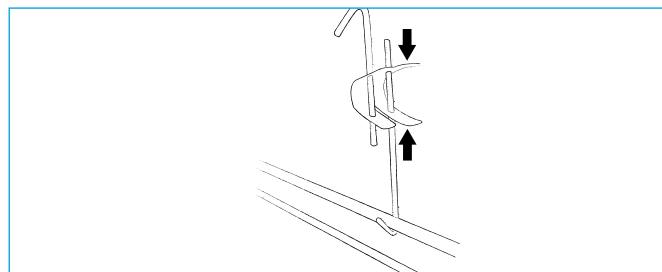

HANGERS (IF T-PROFILES ARE USED FOR THE CEILING)

- Fix adjustable hangers (1) with eye screws or similar securely fastened to the primary construction.
- Install the first hanger at max. 300 mm from the wall. The other hangers should be installed at max. 750 mm c/c.
- If loads from light fittings etc. are to be borne by the ceiling, install additional hangers.
- Refer to distances in figure 1.

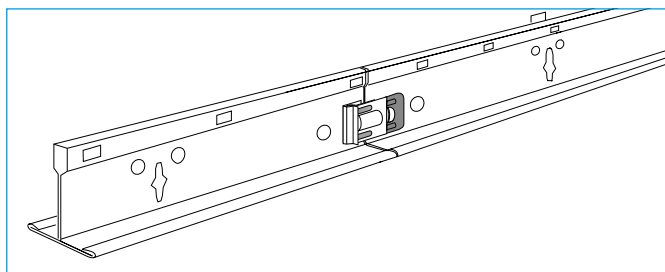

T-PROFILES

- Join the main runners longitudinally by clicking them together.
- Adjust the lengths of the profiles with metal shears, a hacksaw or a circular power saw with a special blade.
- Make sure there is a hanger between the end joints of the main runners and the fire break.
- The T-profile must be fixed to the wall construction.

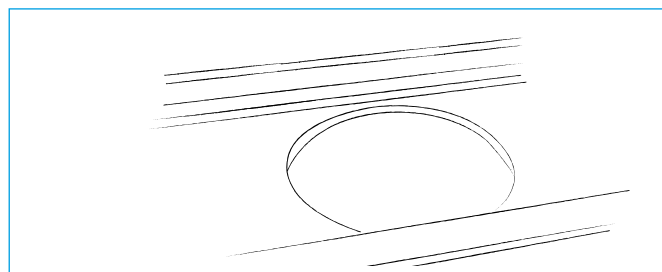

FIXTURES AND FITTINGS

- Units weighing up to 3kg can be installed directly into the panel without reinforcement.
- N.B. The maximum cut-out, when installing in the centre of the panel is $\varnothing 265$ mm / 265x26 5mm.
- Units over 3kg, should be supported independently, so that they do not place any load on the ceiling.

DETAILS



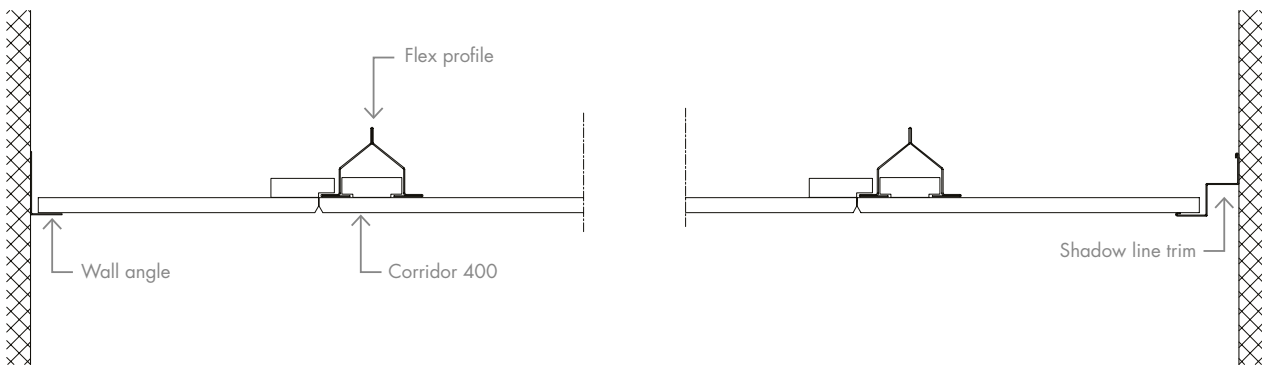
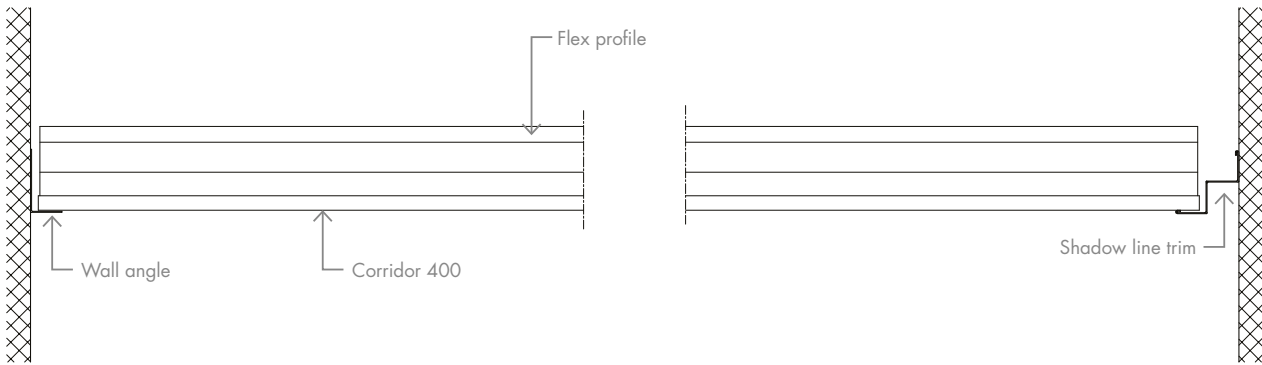

CORRIDOR 400 DIRECT TO WALL

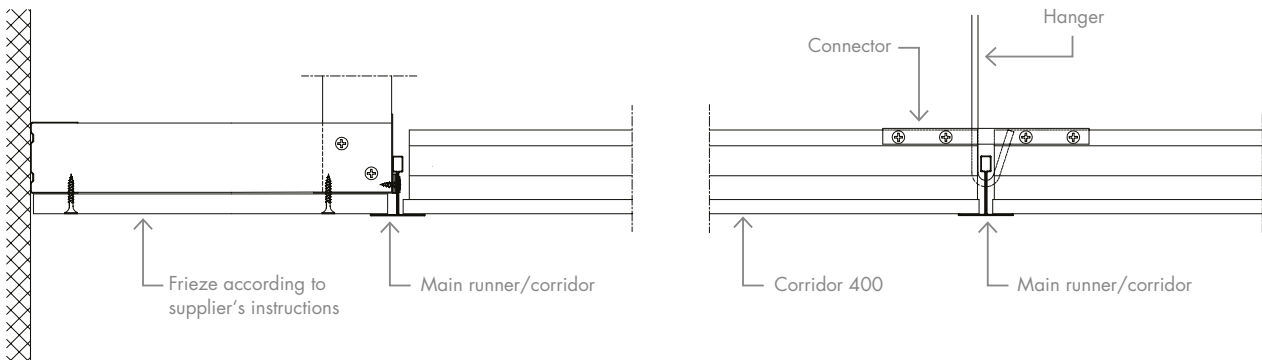
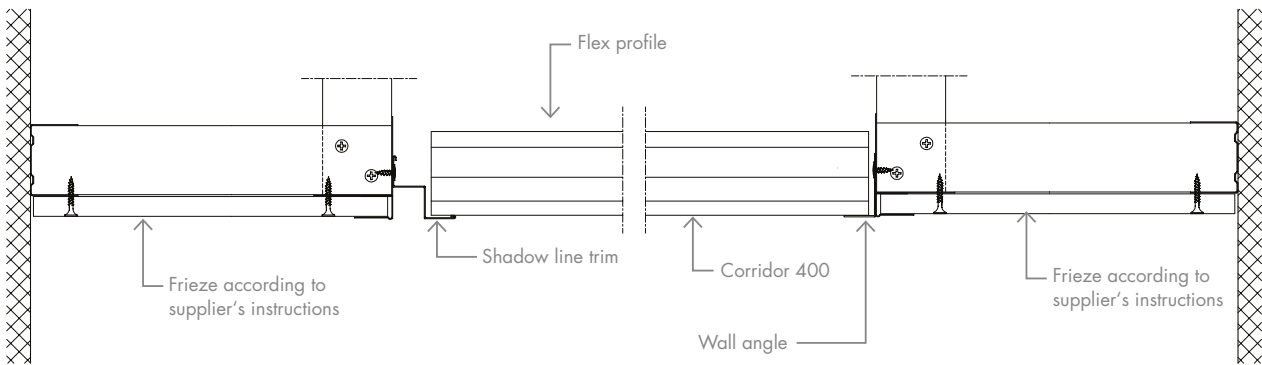

CORRIDOR 400 WITH FIXED FRIEZE

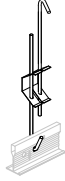

ACCESSORIES

PRODUCT NAME		SAP NO.	W x L x H (mm)
Flex runner		198603	65 x 1194 x 44
		198652	65 x 1794 x 44
		198660	65 x 2394 x 44
Main runner T35		343273	35 x 3700 x 38
Wall angle type MI4020		502754	20 x 3050 x 40
Shadow line trim type MS14		316332	20+20x3000 / 20+20
Adjustable hanger The size specification indicates the min. and max. range		469861	165 - 280
		469868	315 - 580
		469872	510 - 970
		469876	630 - 1210
		469878	755 - 1460
		469880	900 - 1750
		469881	1020 - 1990



DID YOU KNOW THAT ...

gypsum has stood the test of time from the pyramids to a modern versatile building material of today?



Sjukresor
utbetalningar



CORRIDOR SWING

ACOUSTICAL PLANK CEILINGS

Highly functional acoustic ceiling solution for corridors. Swing function – leaving tiles suspended vertically during inspection and maintenance work. Exceptionally easy access to installations requiring no tools. Distinct linear look with a light, floating effect thanks to the air gaps around the tile.

ACOUSTICAL PLANK CEILINGS

CORRIDOR SWING

SIZES

600 x 1200 x 12.5 mm

600 x 1500 x 12.5 mm

600 x 1800 x 12.5 mm

SURFACE

Standard white painted surface
(closest match RAL 9003, gloss 5)

Other colours available on request

DANISH INDOOR CLIMATE LABELLING (DIM)

Indoor value: 10 days

Particle emission: low (< 0.75 mg)

CLEANING

Dust is removed using a dry duster or vacuum cleaner. Marks can be removed with a damp cloth using normal cleaning practices and neutral cleaning solutions.

AMBIENT CONDITIONS

The product is designed to perform under normal conditions of use. Tested at 70% RH and 25°C. The product can withstand ambient temperatures of up to 50°C.

LIGHT REFLECTION

Globe: 72.8%

Quadril: 75.1%

Micro: 72.1%

Regula: 82.6%

LOAD-BEARING CAPACITY

2 / A / No load

FIRE CLASS

A2-s1,d0

ROBUSTNESS

Made of robust, glass fibre reinforced material with excellent pressure resistance. Under normal conditions of use, the product properties are preserved and there is no decomposition of material over time.

WEIGHT

Indicative tile weight: 9.50 – 10.20 kg/m².

All according to type of perforation.



CERTIFICATES

- Declaration of Conformity (EN 14190)
- Danish Indoor Climate Labelling

DEMOUNTABLE SELF-SUPPORTING CEILING CORRIDOR SWING

ACOUSTICS

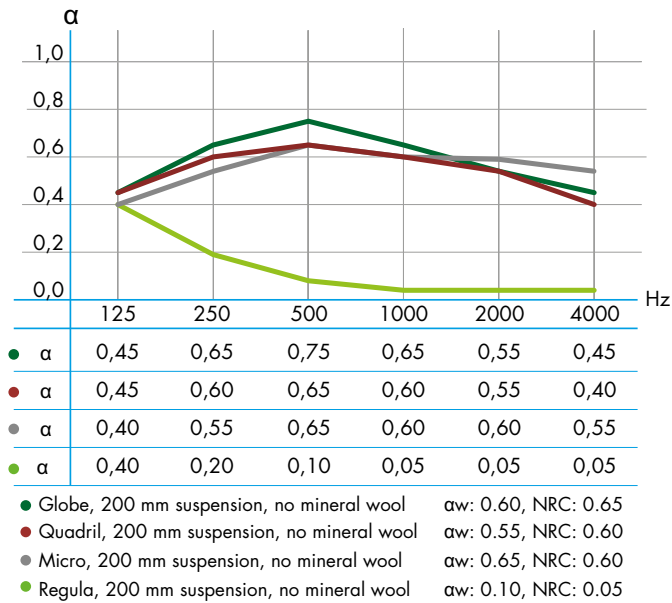

For acoustic data on alternative constructions please see
 "Absorption Data" at knaufdanoline.com

EDGES



Edge E

Edge E (tegular)
 No visible grid;
 air gaps around tiles

For Globe, Quadril, Micro





PERFORATION

Also available as Regula.

Other perforation patterns are manufactured to order.



Globe, Ø6 mm
15 mm c/c
Perforation: 10%

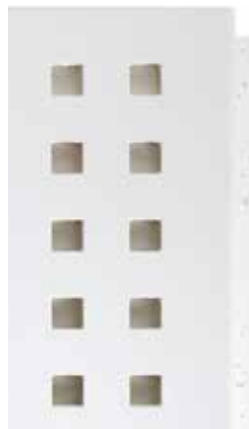

Quadril, 12 x 12 mm
30 mm c/c
Perforation: 11.5%



Micro, 3 x 3 mm
8.3 mm c/c
Perforation: 9.9%

INSTALLATION GUIDE

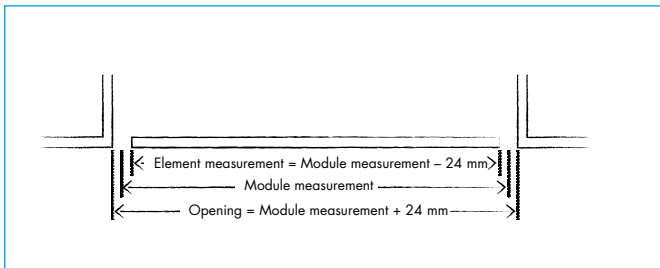
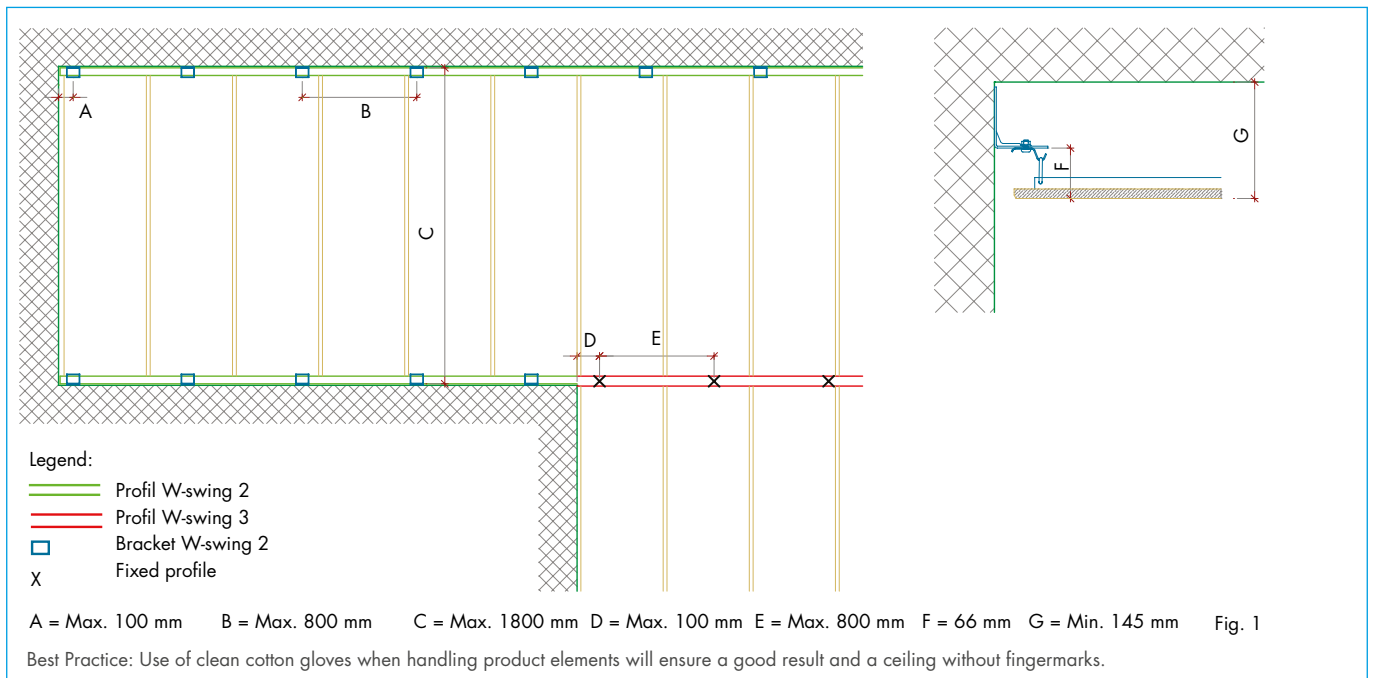

PLANNING THE CEILING SURFACE

- The board elements are 24 mm smaller than the module size:
 Module: 600 x 1200/1500/1800
 Element: 576 x 1176/1476/1776
 Opening: 624 x 1224/1524/1824

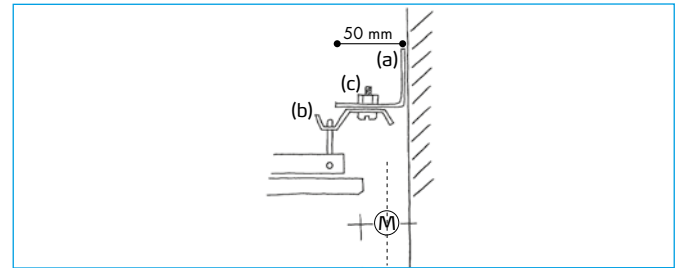

DIMENSIONAL OUTLINE, WALL JUNCTION

- M indicates the module line.
- There must be a 12 mm gap on each side of M.
- The bracket W-Swing 2 (a) is fixed to the wall at c/c 800 mm.
- The W-swing 2 profile (b) is fixed to the bracket with the W34 bolt (c).

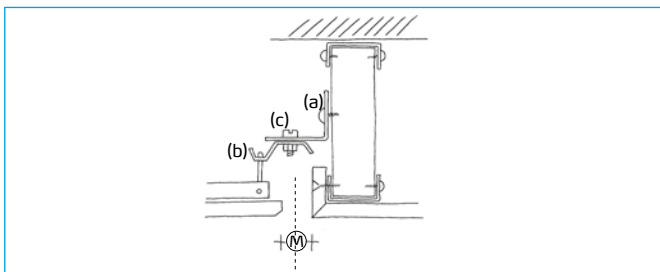

DIMENSIONAL OUTLINE, FIXED FRIEZE

- M indicates the module line.
- There must be a 12 mm gap on each side of M.
- The bracket W-Swing 2 (a) is fixed to the vertical profiles and horizontal U-profiles are installed so the fixed frieze can be screwed onto them.
- The W-swing 2 (b) profile is fixed to the bracket with the W34 bolt (c).

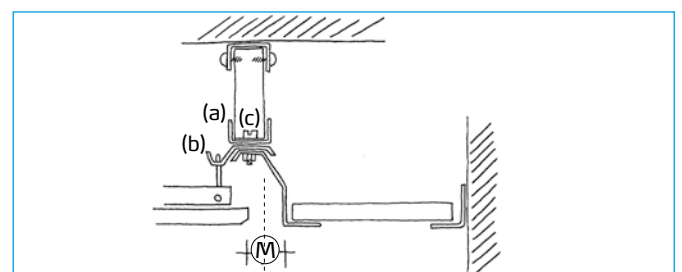

DIMENSIONAL OUTLINE, DEMOUNTABLE FRIEZE

- M indicates the module line.
- There must be a 12 mm gap towards the Corridor Swing element and a 18 mm gap to the frieze.
- Horizontal U-profiles and vertical C-profiles are installed in order to create a rigid frame for the swing profile.
- W-swing 2 (b) and 4A profiles are fixed at c/c 800 mm in the vertical steel profiles with the W34 bolt (c).
- The wall angle is fixed to the wall at c/c 400 mm

INSTALLATION GUIDE

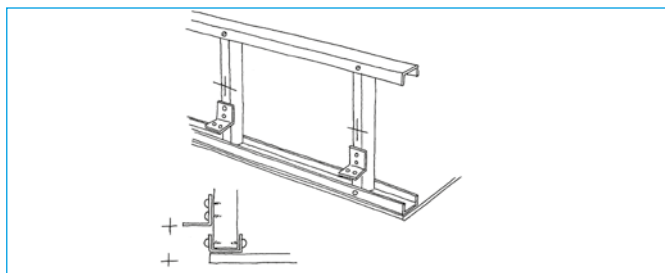

FIXING OF THE METAL CLIP

- The brackets are fixed to the wall or vertical steel profiles at c/c max. 800 mm. There must always be a bracket behind the joints of Swing 2 profiles.
- The lowest edge of the bracket should be 65 mm higher than the desired ceiling height.
- It is very important that the frame work is rigid so it cannot deform the elements when installed.

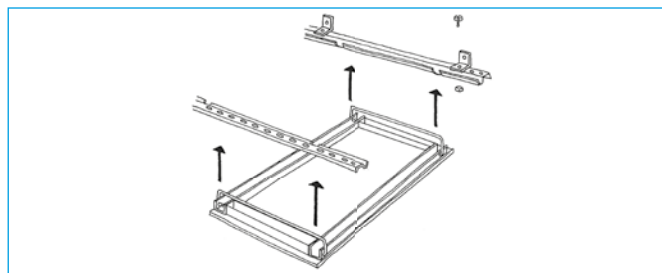

PROFILE DISTANCES

- The W-swing 2 profiles are installed under the bracket with the W34 nut and bolt.
- Now the distance between the "suspension points" on the W-swing 2 profiles must be adjusted, so the distance between them is the length of the element minus 50 mm.
- The two Swing profiles must be installed, so the cut-outs are directly opposite each other due to the following installation of the actual element.

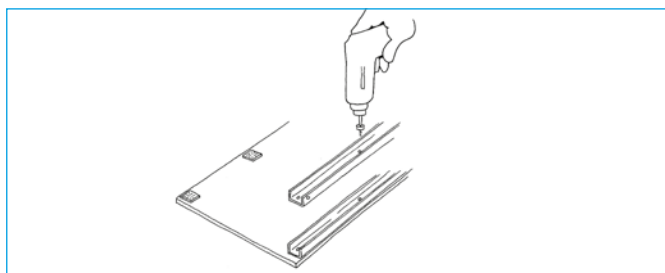

ASSEMBLY OF THE ELEMENTS

- The elements come with pre-fitted clips.
- The U-profile-swing are fixed with the supplied screws through the pre-fitted clips into the element.
- The distance between the end of the profile to the edge of the element must be 15 mm.
- Only one U-profile-swing is fixed at this stage.
- The base for fixing the load bearing profiles must be plane and solid.
- There must be no deflection of the profile during the fixing of it.

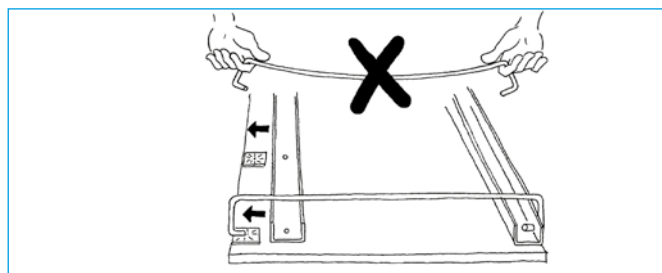

INSTALLATION OF SWING HANGER

- The Swing hanger is fixed to the fastened SW15 profile and the other U-profile-swing is pushed into its slot so the hanger is fixed in the hole of the U-profile-swing profile.
- Now the other U-profile-swing profile can be fixed using previous described method.
- It is not recommended installing the hanger by tensioning as it will give an inappropriate sideways force on the SW15 profiles.

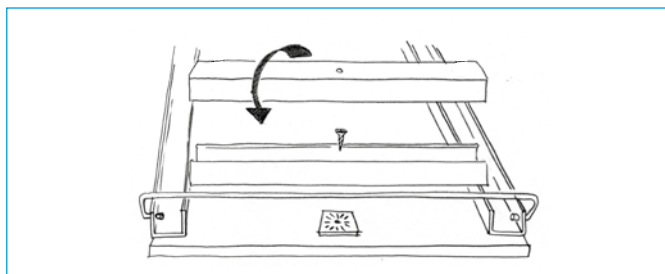

INSTALLATION OF SWING CROSS PROFILE

- The cross profile is placed onto the metal clip so that outer side of the cross profile aligns with the edges on the side profiles.
- The cross profile is pressed tightly against the element.
- The screw is fixed through the profile into the metal clip.

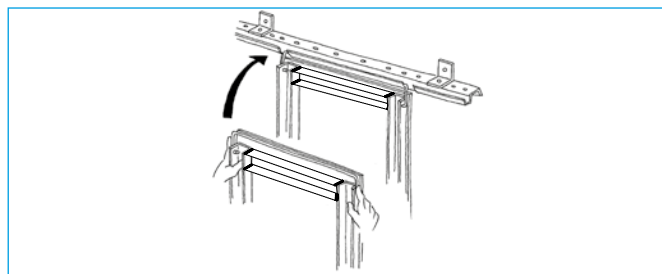

INSTALLATION OF THE ELEMENTS

- Start out by hanging the elements along one of the sides.
- The element is kept vertical with the hanger pointing up and the hanger is clasped on the W-swing 2 profile.

DETAILS

CORRIDOR SWING DIRECT TO WALL - CROSS SECTION IN CORRIDOR

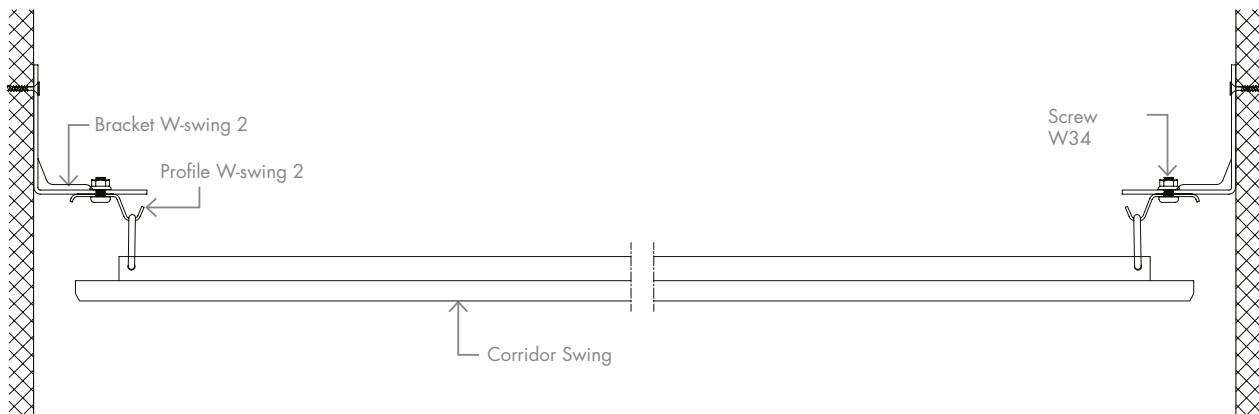

Corridor Swing with fixed frieze - length section in corridor

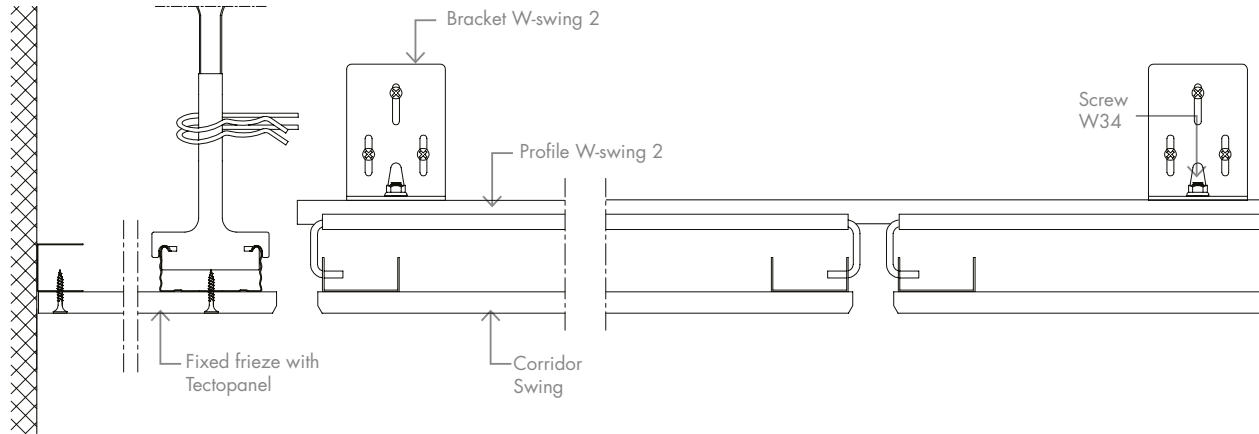



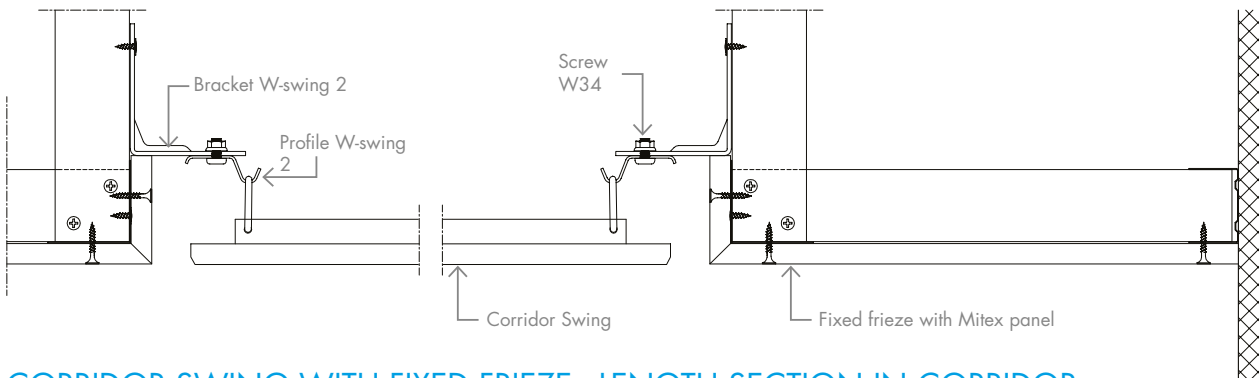



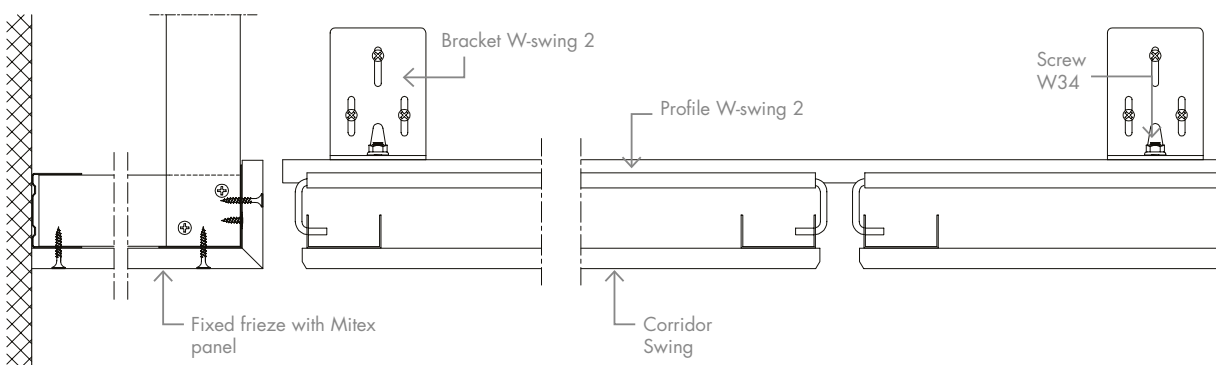

CORRIDOR SWING WITH FIXED FRIEZE - CROSS SECTION IN CORRIDOR



CORRIDOR SWING WITH FIXED FRIEZE - LENGTH SECTION IN CORRIDOR



ACCESSORIES

PRODUCT NAME		SAP NO.	W x L x H (mm)
Profile W-swing 2		198315	42 x 2400 x 16
Profile W-swing 3		198797	92 x 2400 x 16
Bracket W-Swing 2		198324	70 x 58 x 80
Nut/Bolt Nut W34		199036	-
Swing hanger		198323	Ø4 x 582 x 35
Screw for profiles		198978	11
U-profile-swing		198320 198321 198322	45 x 1146 x 20 45 x 1446 x 20 45 x 1746 x 20
Cross profile		198959	45 x 479 x 20

DID YOU KNOW THAT...

People spend 90% of time indoor,
and that Cleaneo Technology
actively purifies the indoor air?

CORRIDOR PLANKS

ACOUSTICAL PLANK CEILINGS

Rectangular ceiling modules with free span up to 2100 mm. Available with 4 different edges enabling a range of elegant designs.

ACOUSTICAL PLANK CEILINGS

CORRIDOR PLANKS

SIZES

300 x 1200 mm

300 x 1500 mm

300 x 1800 mm

300 x 2100 mm

Plaza in 9.5 mm and 12.5 mm, Belgravia, Markant and Contur in 12.5 mm thickness.

SURFACE

Standard white painted surface
(closest match RAL 9003, gloss 5)

Other colours available on request

DANISH INDOOR CLIMATE LABELLING (DIM)

Indoor value: 10 days

Particle emission: low (< 0.75 mg)

CLEANING

Dust is removed using a dry duster or vacuum cleaner. Marks can be removed with a damp cloth using normal cleaning practices and neutral cleaning solutions.

LIGHT REFLECTION

Globe: 72.8%

Quadril: 75.1%

Micro: 72.1%

Tangent: 70.9%

Regula: 82.6%

AMBIENT CONDITIONS

The product is designed to perform under normal conditions of use. Tested at 90% RH and 30°C. The product can withstand ambient temperatures of up to 50°C.

LOAD-BEARING CAPACITY

1 / B / No load

2 / A / 30N

FIRE CLASS

A2-s1,d0

ROBUSTNESS

Made of robust, glass fibre reinforced material with excellent pressure resistance. Under normal conditions of use, the product properties are preserved and there is no decomposition of material over time.



CERTIFICATES

- Declaration of Conformity (EN 14190)
- Danish Indoor Climate Labelling

DEMOUNTABLE SELF-SUPPORTING CEILING CORRIDOR PLANKS

ACOUSTICS

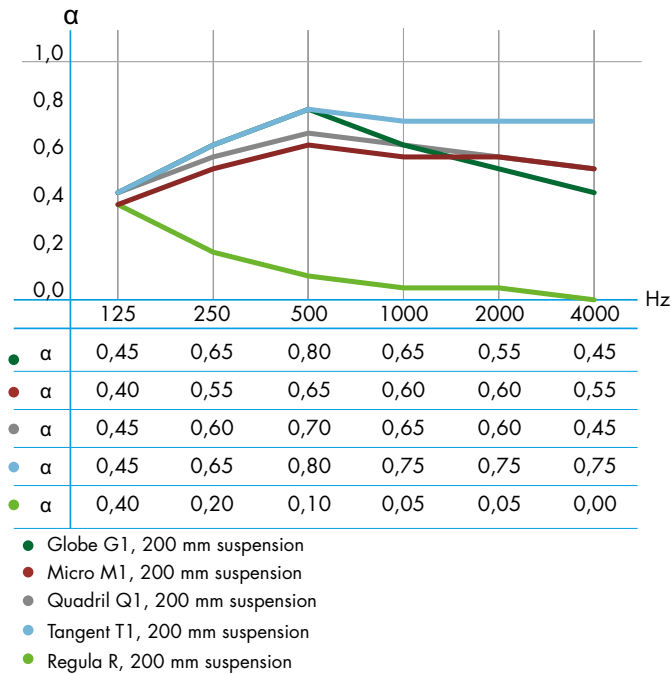

For acoustic data on alternative constructions please see
"Absorption Data" at knaufdanoline.com

EDGES



Edge A - Plaza

(SQUARE EDGE) / S15
or S24, Visible grid



Edge E - Markant

(REGULAR) / S15 or S24,
Recessed grid



Edge E - Belgravia

(REGULAR) / S15 or
S24, Recessed grid



Edge D - Contur

(REBATED AND GROOVED)
/ S24, Concealed grid



PERFORATION

Also available as Regula.

Other perforation patterns are manufactured to order.



Globe, Ø6 mm,
15 mm c/c



Quadril, 12 x 12 mm,
30 mm c/c



Micro, 3 x 3 mm,
8.3 mm c/c



Tangent, 4 x 14 mm,
10/20 mm c/c

DESIGNPANEL

ACOUSTICAL CEILING PANELS

Ceiling lining with a unified expression without visible joints. Suitable for flat surfaces and for curving on site or from the factory.

DID YOU KNOW THAT ...

gypsum was used by the ancient Egyptians as jointing material in monuments built over 4000 years ago?

ACOUSTICAL CEILING PANELS

DESIGNPANEL

SIZES

Dimension	Available with:
900 x 2700 x 12.5 mm*	Globe, Quadril, Micro
1200 x 2400 x 12.5 mm	Globe, Quadril, Micro
900 x 2400 x 12.5 mm	Tangent

SURFACE

Untreated

DANISH INDOOR CLIMATE LABELLING (DIM)

Indoor value: 10 days
Particle emission: low (< 0.75 mg)

CLEANING

Dust is removed using a dry duster or vacuum cleaner. Removal of marks depends on the paint used on site, although a damp cloth using normal cleaning practices and neutral cleaning solutions is normally suitable for minor marks. In the case of stubborn marks or if in doubt refer to the paint manufacturer's recommendations.

AMBIENT CONDITIONS

The product is designed to perform under normal conditions of use. Tested at 90% RH and 30°C. The product can withstand ambient temperatures of up to 50°C.

LIGHT REFLECTION

Depends on the paint used on site.

LOAD-BEARING CAPACITY

2 / A / No load	900 x 2700	G1F, Q1F, Q2F M1F, M2F
2 / B / 30N	1200 x 2400	G2F, Q2F Q4F, M2F
1 / A / No load	900 x 2400	T3L1, T3L2 T3L4

FIRE CLASS

A2-s1,d0

FIRE RATING

Class 1; K₁ 10, A2-s1,d0. Can be used in a BD 30 construction.

ROBUSTNESS

Made of robust, glass fibre reinforced material with excellent pressure resistance and can therefore be used on walls as well as ceilings. Under normal conditions of use, the product properties are preserved and there is no decomposition of material over time.

WEIGHT

Indicative tile weight: 9.20 kg/m².
All according to type of perforation.



CERTIFICATES

- Declaration of Conformity (EN 14190)
- Danish Indoor Climate Labelling

ACOUSTICAL CEILING PANELS DESIGNPANEL

ACOUSTICS

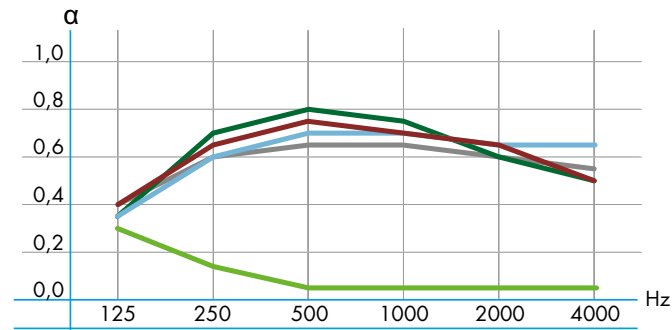

● α	0,35	0,70	0,80	0,75	0,60	0,50
● α	0,40	0,65	0,75	0,70	0,65	0,50
● α	0,40	0,60	0,65	0,65	0,60	0,55
● α	0,35	0,60	0,70	0,70	0,65	0,65
● α	0,30	0,15	0,05	0,05	0,05	0,05
● G1F, 65 mm suspension, 50 mm mineral wool						aw: 0.65, NRC: 0.70
● Q1F, 65 mm suspension, 50 mm mineral wool						aw: 0.65, NRC: 0.70
● M1F, 65 mm suspension, 50 mm mineral wool						aw: 0.65, NRC: 0.65
● T3L1, 65 mm suspension, 50 mm mineral wool						aw: 0.70, NRC: 0.65
● Regula, 65 mm suspension, 50 mm mineral wool						aw: 0.10, NRC: 0.05

For acoustic data on alternative constructions please see "Absorption Data" at knaufdanoline.com

EDGES



Edge B1

Edge B1 (EN 520). 4 tapered edges
No visible joints

For Globe, Quadril, Micro and Tangent



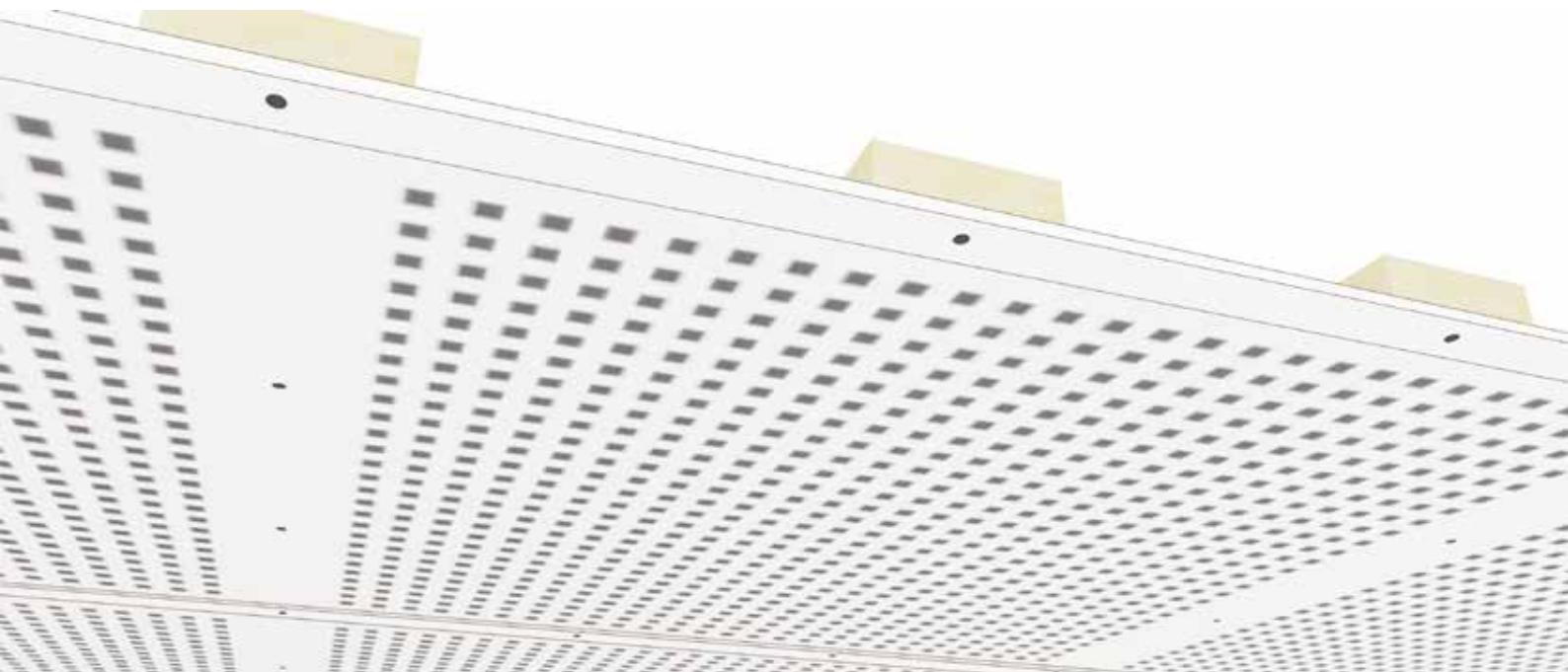

PERFORATION

Also available as Regula.

Other perforation patterns are manufactured to order.



Globe, Ø6 mm,
15 mm c/c
Perforation: 5.3 - 9.8%



Quadril, 12 x 12 mm,
30 mm c/c
Perforation: 7.8 - 13%



Micro, 3 x 3 mm,
8.3 mm c/c
Perforation: 7.1 - 9.8%



Tangent, 4 x 14 mm,
10/20 mm
Perforation: 13.3 - 15.0.
15.8%

INSTALLATION GUIDE - FURRINGS OF WOOD

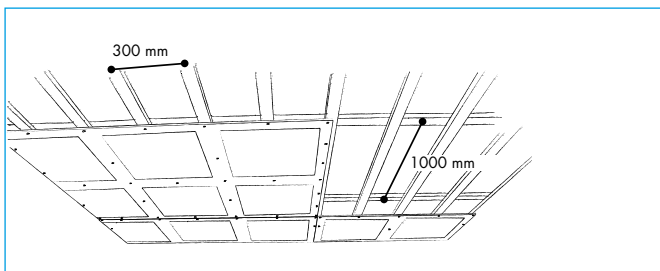
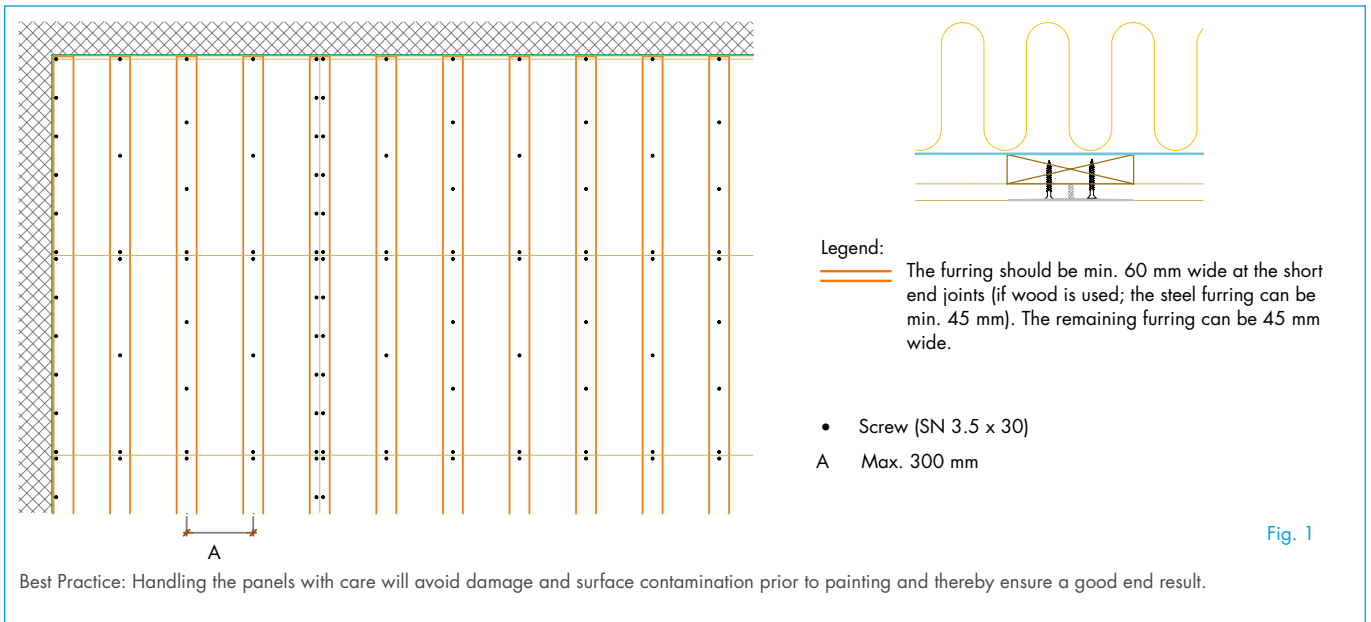

FURRING

- Furrings can be of wood or steel profiles; CD2 system can also be used as substrate - for more details please see page 92.
- Also see the sections "Fire" and "Acoustics" on page 95.

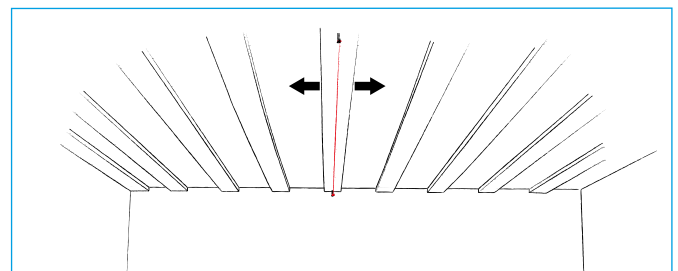

CEILING LAYOUT AND FURRING SYSTEM

- Divide the ceiling surface from the centre of the room or in accordance with the existing ceiling plans.
- As a rule, the furring must be at right angles to the longitudinal direction of the elements at centres of 300 mm to ensure that the panels are properly supported. Ensure full support for the short edges (e.g. steel band) on longitudinal furrings.
- Please note that expansion joints must be established on extensive ceiling surfaces at max.intervals of 15 metres in both directions. See detailed drawings on knaufdanoline.com
- Also see the sections "Fire" and "Acoustics" on page 95.

INSTALLATION GUIDE - FURRINGS OF STEEL (P45-S25)

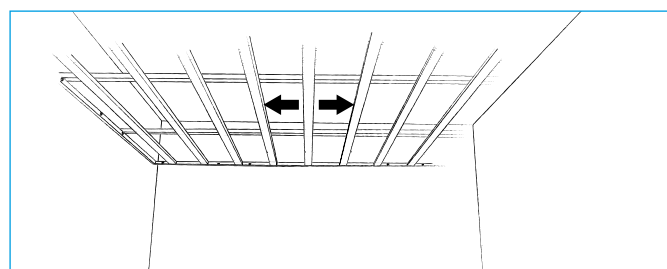
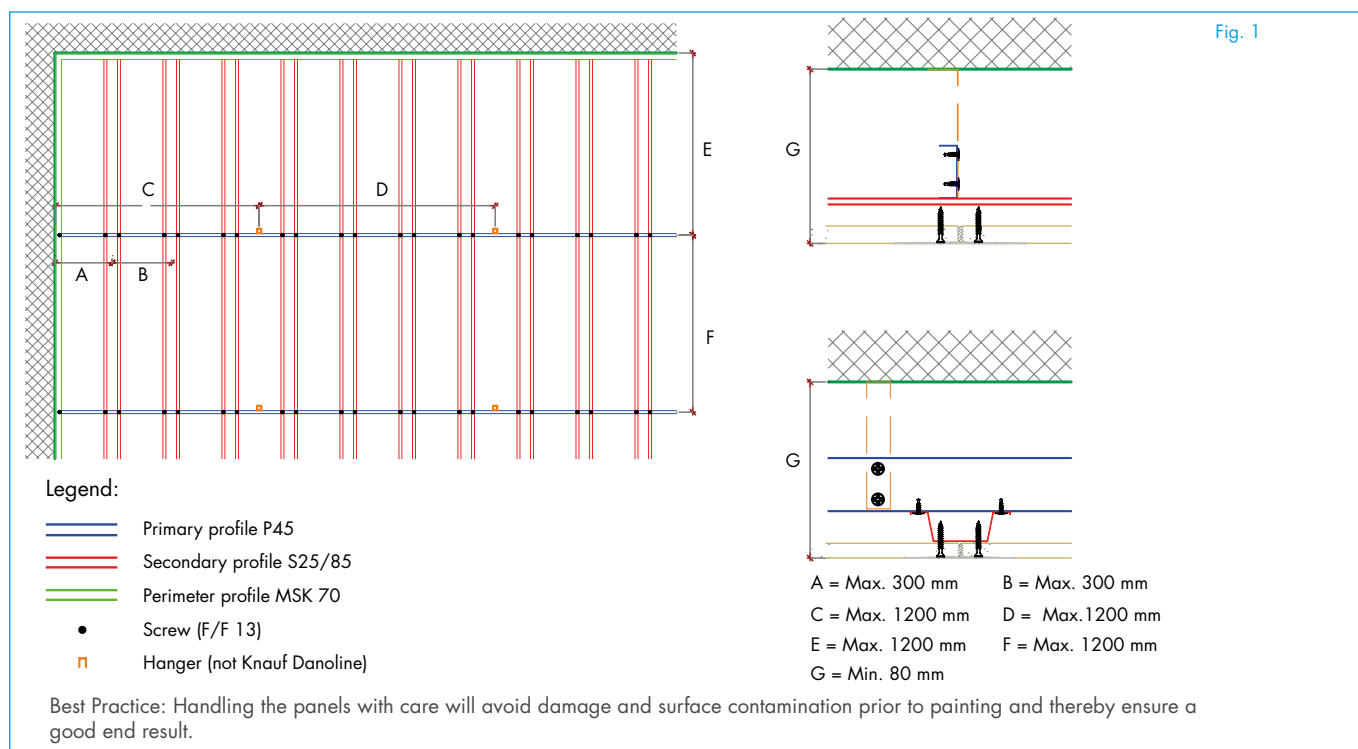

CEILING LAYOUT

- Divide the ceiling surface from the centre of the room or in accordance with the existing ceiling plans.
- The furrings should usually run across the longitudinal direction of the element with a C-C distance of 300 mm. This will ensure that the end edges are fully supported. Ensure full furring support at short edge joints for longitudinal furrings (e.g. steel band).
- Please note that expansion joints must be established on extensive ceiling surfaces at max.intervals of 15 metres in both directions.
- Where conditions indicate an increased risk of movement in a building, this must be taken into account by reducing the distance between expansion joints.

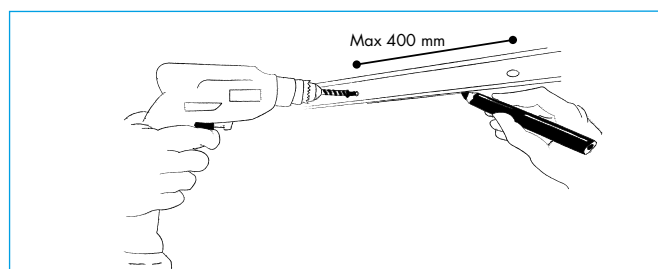

INSTALLING THE WALL PROFILE

- Mark out.
- Install the wall profile MSK70. Choose the method of fixing in accordance with the substrate.

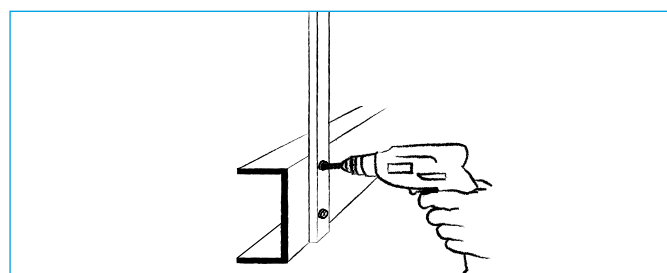

PRIMARY PROFILES/HANGERS

- Install primary profiles every 1200 mm centres (max).
- Using rigid or strap hangers. Connect hangers to primary profile with 2 screws (F/F 13).

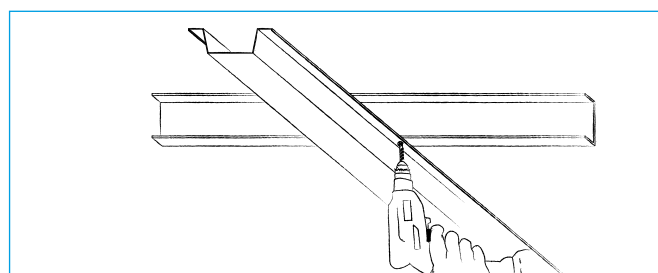

SECONDARY PROFILES

- Fix the secondary profiles to the primary profiles at every 300 mm. Use 2 screws (F/F 13) in each connection.

INSTALLATION GUIDE - FURRINGS OF STEEL (CD2)

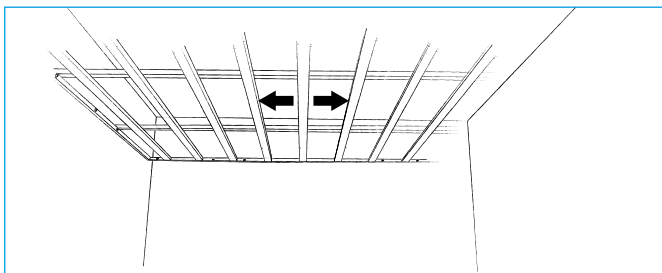
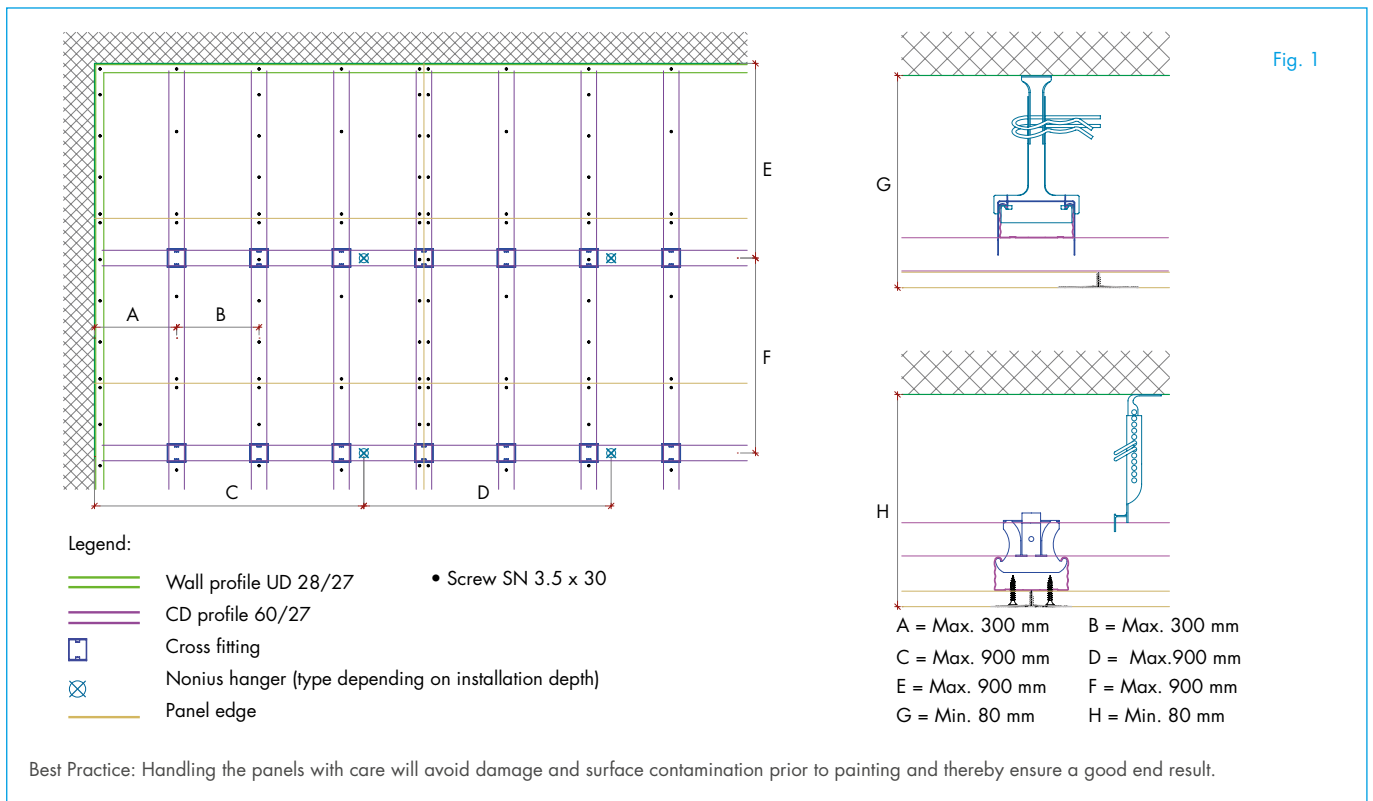

CEILING LAYOUT

- Divide the ceiling surface from the centre of the room or in accordance with existing loft plans.
- The furrings should usually run across the longitudinal direction of the element with a C-C distance of 300 mm. This will ensure that the end edges are fully supported. Ensure full furring support at short edge joints for longitudinal furrings (e.g. steel band).
- Please note that expansion joints must be installed in both directions at an interval of maximum 15 metres when working with large ceiling surfaces. Please see detail drawings on knaufdanoline.com.
- Where conditions indicate an increased risk of movement in a building, this must be taken into account by reducing the distance between expansion joints.

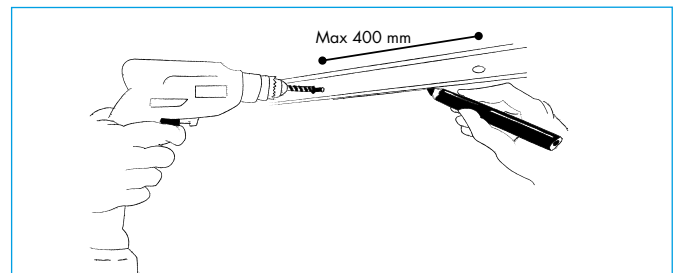

INSTALLING THE WALL PROFILE

- Mark out.
- Install the wall profile UD 28/27. Choose the method of fixing in accordance with the substrate.

INSTALLATION GUIDE - FURRINGS OF STEEL (CD2)

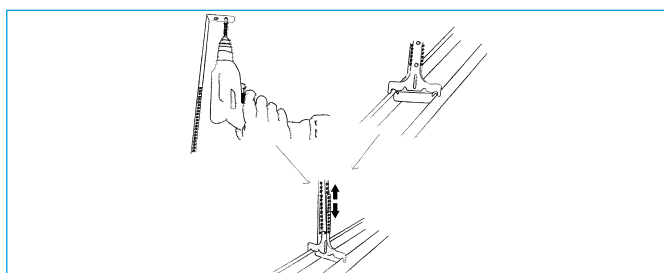

HANGERS

- Secure the upper part to the construction above it at 900 mm c/c. Choose the fixings in accordance with the substrate.
- Secure the lower part to the primary profile.

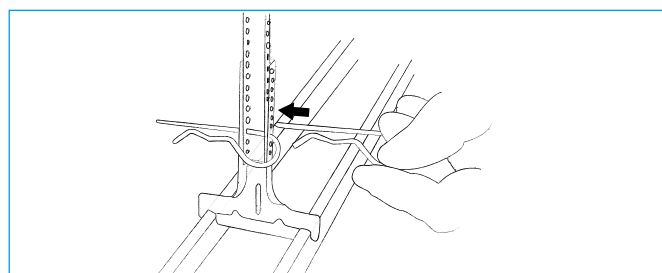

PRIMARY PROFILES

- Connect the two parts of the hangers with two split pins, one immediately above the other.

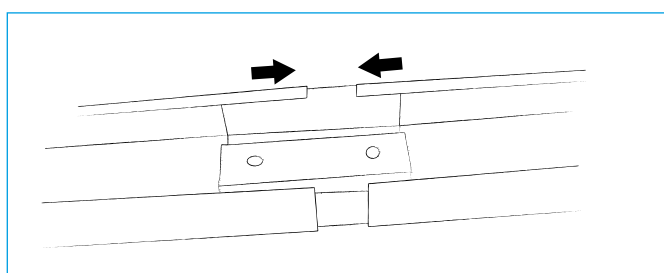

JOINING CD-PROFILES

- Join the CD profiles with the help of length connectors.

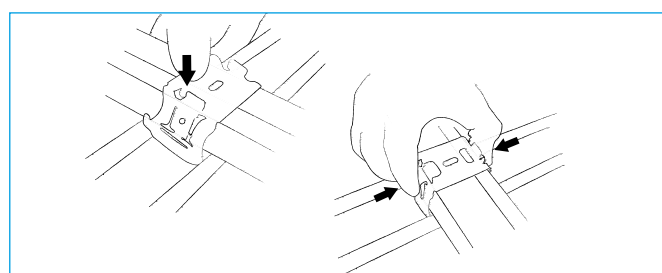

SECONDARY PROFILES

- Place a cross fitting on the primary profile.
- Press the underlying secondary profile into it.
- Adjust the locations of the secondary profiles and lock the cross fitting.
- See distances in figure 1.

INSTALLATION GUIDE - PANELS AND FILLING

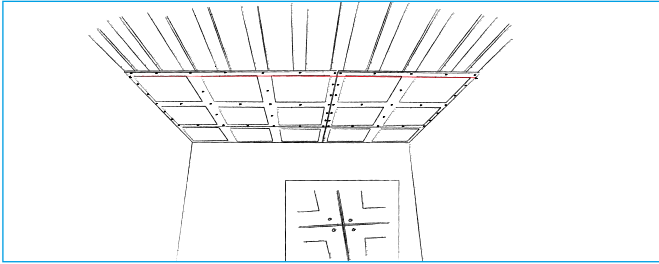

INSTALLATION

- Install the first row of panels with the help of string.
- See distances in figure 1 page 90 -92 all according to furring. Screws must be fixed 10 mm from the long panel edge and 15 mm from the end panel edge.
- Panel length and breadth have a tolerance of ± 0.4 mm. When installing, take into account the location of perforation fields to ensure they are flush in both directions. This can mean that there can be up to 4 mm between panel edges.
- The panels are supplied undersized and must be installed at distances of up to 4 mm from each other to ensure that it is possible to insert filler all the way up between the edges of the panels.
- Cut the elements to size from the front with a fine-toothed saw.
- Designpanel should always be installed with bevelled edge (same applies for friezes). We recommend using Plan-4 Board for friezes.
- If joints with cut edges cannot be avoided, match cut edge to cut edge. We recommend sanding and priming cut edges before installation. Always maintain a gap between the panel edges for a 3-5 mm grout seal.
- Apply Knauf Uniflott (without paper strips) as grout.
- Alternatively, the perforated Designpanel boards can run right to the wall, using filler to fill the perforated holes when an unperforated surface is required. In such instances, the perforated holes should be sprayed first with deep primer and then filled with Knauf Uniflott, before finishing with Knauf Uniflott Finish.

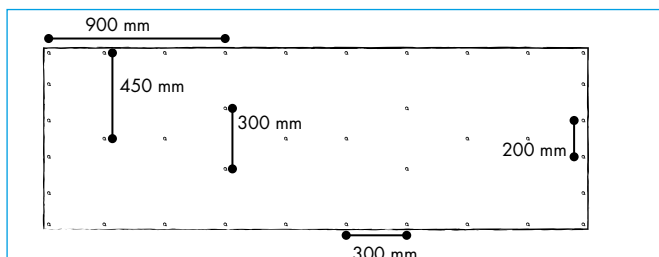

SCREW DISTANCES 900 X 2700

- Fix the panels according to the template above.

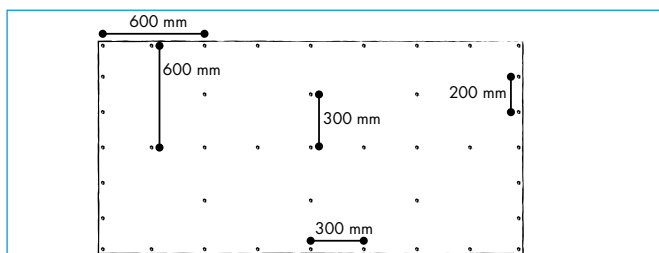

SCREW DISTANCES 1200 X 2400

- Fix the panels according to the template above.

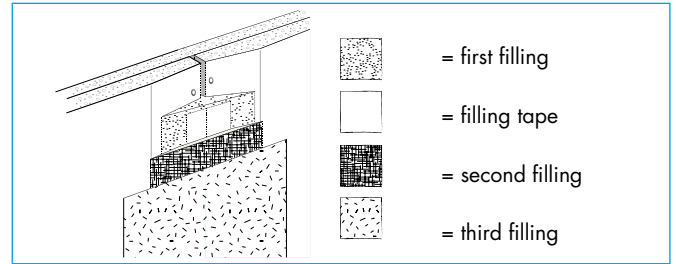

FILLING

- Apply the first layer of filler (Easy Filler Light). Ensure that it is pressed firmly between the panel edges if there is a gap between them.
- Avoid filler in the perforated holes (can be masked with a sensitive masking tape, but check that the tape can be removed without damaging the cardboard surface before starting).
- Apply filler tape to the wet filler.
- The first filling and application of filler tape can be carried out in a single, very simple operation by using a Mini Bazooka.
- Allow the filler to dry. Make sure that the filler is completely dry before sanding. Sand with fine sandpaper. Be careful not to damage the cardboard surface.
- Apply the second layer of filler (Easy Filler Light).
- Allow the filler to dry. Make sure that the filler is completely dry before sanding. Sand with fine sandpaper. Be careful not to damage the cardboard surface.
- Apply the third layer of filler (Easy Filler Light). Make sure that the filler is completely dry before sanding. Sand with fine sandpaper until the joint is completely smooth. Be careful not to damage the cardboard surface.

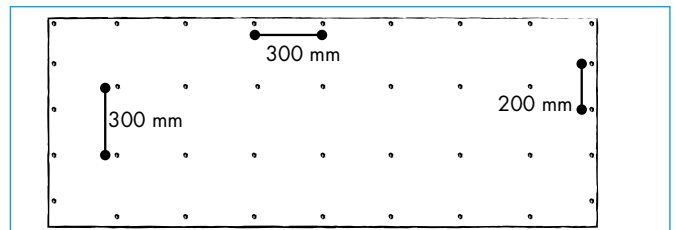

SCREW DISTANCES 900 X 2400 (TANGENT)

- Fix the panels according to the template above.

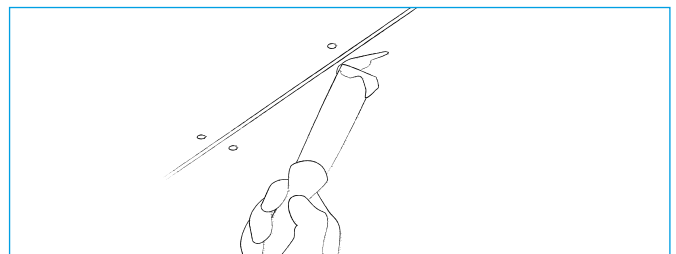

FILLING SCREW HOLES

- Check that the screws have been countersunk.
- Apply filler (Knauf Uniflott Finish or Easy Filler). Overfill slightly.
- We recommend the use of Knauf Danogips „Acoustic filling knife for holes“ in order to avoid filler getting into the perforation holes.

FILLING PERFORATED HOLES

- spray the holes first with deep primer and fill with Knauf Uniflott. Finish off with Knauf Uniflott Finish.

INSTALLATION GUIDE - PAINTING

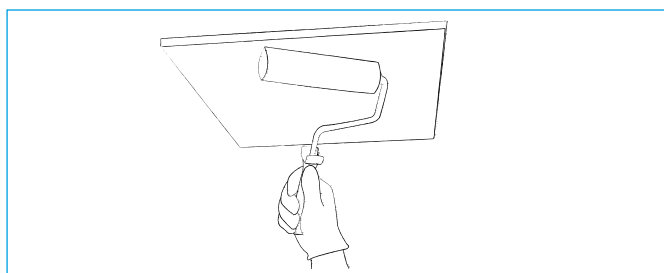

PAINTING

- Make sure that the filler is completely dry and the surface is smooth and free from dust.
- Priming should be carried out in accordance with the paint manufacturer's instructions.
- Apply the paint with a roller so that the acoustic felt on the perforated panels is not sealed. Use a fine mohair roller.
- Make sure that the paint is not too thick and avoid applying too much paint at a time.
- Spraying cannot be recommended as this could influence the acoustic properties of the panels.

ACOUSTICS

- A perforated gypsum panel will lose its acoustic function if the perforations are blocked (this applies to the front and back of the panel).
- Where applicable, a vapour barrier should therefore always be placed behind the furrings so that it does not come into contact with the back of the perforated panel.
- When installing Designpanel on a fixed surface we recommend filling the cavity between the back of the panel and the furring with mineral wool. This is primarily to ensure low frequency sound absorption.

FIRE

- If there is a requirement for BD30 follow the instructions for this construction.
- The furring should be dimensioned in accordance with the load in question and should be at least 45 mm in width. Where BD30 constructions are concerned 25 x 100 mm furrings should be used.

INSTALLATION GUIDE - CURVED PANELS

Apply water on the front face and leave for 30 minutes. If necessary the panel can be covered in plastic to assist the panel in absorbing the water.

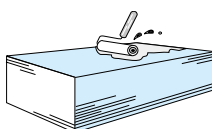

Lay the panel over a template. Secure the panel on one side of the template.

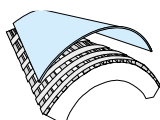

To minimize the risk of mold formation during the process, make then sure that a fast drying of the boards is present. A good ventilation with high air exchange and relative high temperature is needed and with advantage the boards can be bended and dried out before mounting.

Press the panel against the template using a batten, moving it every 100 mm. Secure the panel on the other side of the template. Make sure that the panel is fully dry before mounting or closing the construction.

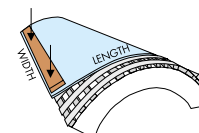

DETAILS



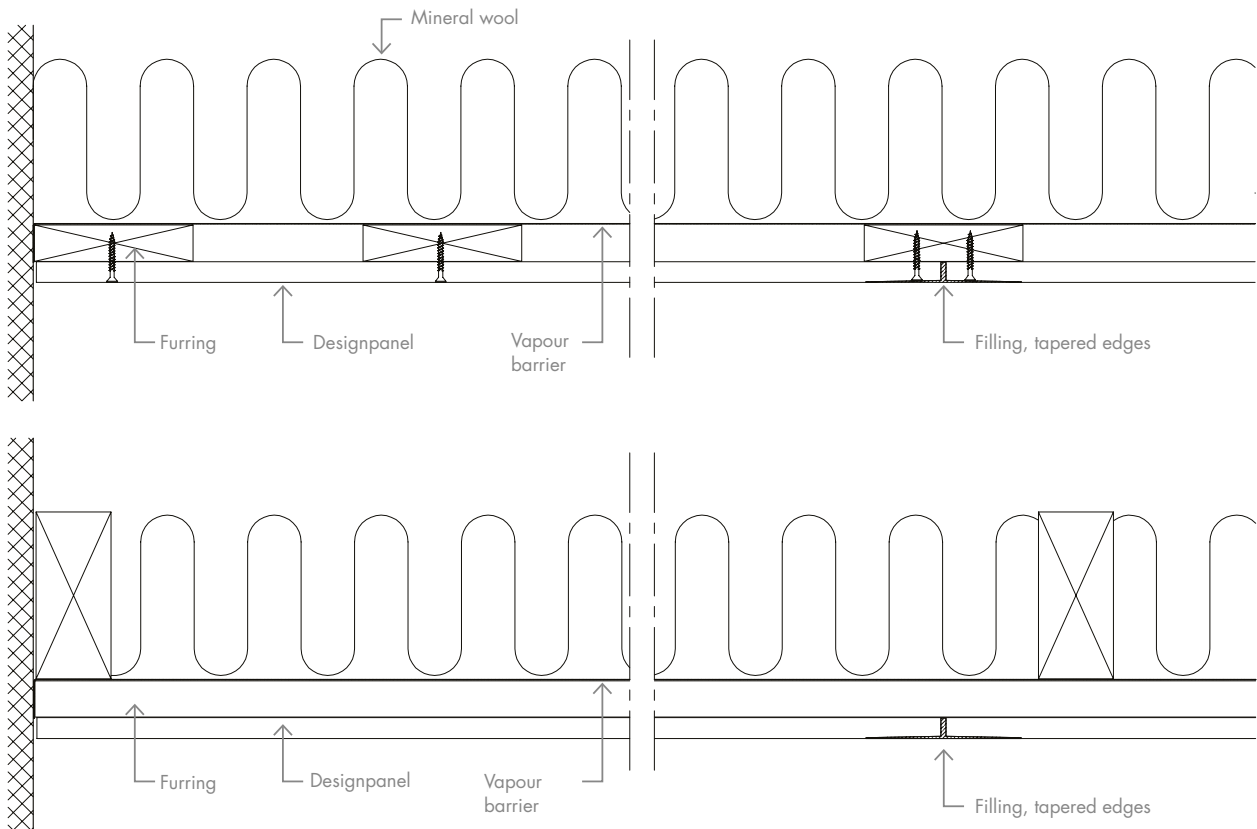



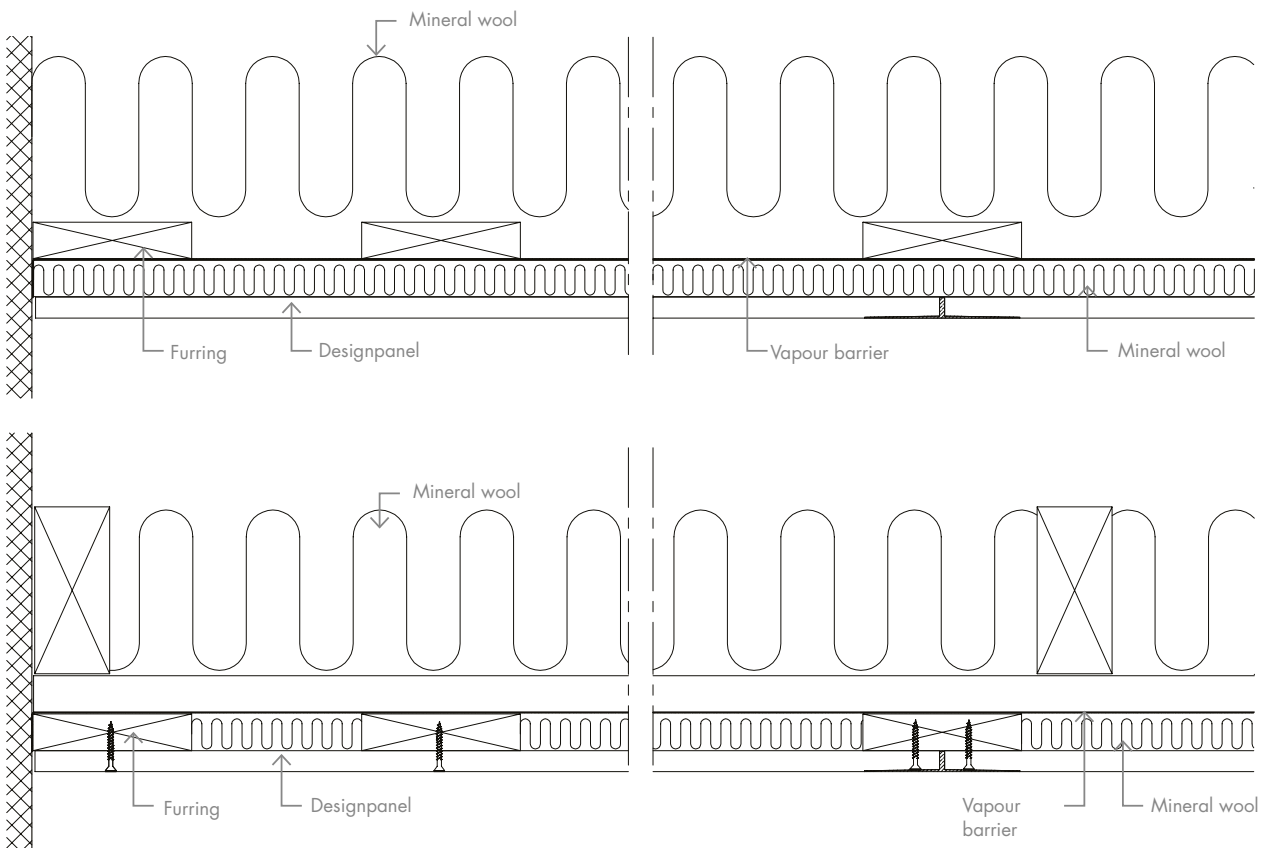



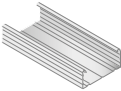





DESIGNPANEL WITH 1 LAYER FURRING



DESIGNPANEL WITH CROSS-FURRING



ACCESSORIES

	PRODUCT NAME		SAP NO.	W x L x H (mm)	Consumption per. m ²
Accessories for system CD2	Primary / secondary CD 60/27-profile		3294	60 x 4000 x 27	4.6 m
	Wall angle UD 28/27		181589	28 x 3000 x 27	1.0*
	Length connector CD 60/27		181080	59 x 80 x 28	1.1 pcs.
	Cross-fitting		3446	-	3.3 pcs.
	Split pin for hanger		198907	-	2.6 pcs.
	Nonius hanger lower		198904	-	1.3 pcs.
	Nonius hanger upper 85mm		198905	125 - 185	1.3 pcs.
	Nonius hanger upper 135mm		198906	135 - 235	
	Nonius hanger upper 235mm		198923	235 - 340	
	Nonius hanger upper 340mm		198924	340 - 440	
	Nonius hanger upper 440mm		198925	440 - 540	
	Nonius hanger upper 540mm		198926	540 - 640	
	Nonius hanger upper 640mm		198927	640 - 740	
	Nonius hanger upper 740mm		198928	740 - 840	
Nonius hanger upper 840mm	198929		840 - 940		
Nonius hanger upper 940mm	198930		940 - 1040		
Accessories for system P45-S25	MSK 70 Perimeter profile		181029 181030	2500 3600	1.0 m*
	P45 Primary profile		181684	3600	0.85 m
	S25/85 Secondary profile		181685	3800	3.6 m
	F/F13 Screw		2017	13	8 pcs.
	Screw SN3.5x30		3503	3,5 x 30	20 pcs.
	Joint Filler - Easy Filler Light		235309	-	0.35 kg
	Uniflott Finish		129801	8 kg	≤ 0.1 kg
	Filling tape		314828	-	1.5 m
	Mini Bazooka		181232	-	-
	Filling knife		73962	-	-

*Depending on room size.

PATTERNS DESIGNPANEL 900 X 2700

Following perforation patterns are available for Designpanel Globe, Quadril og Micro 900 x 2700 mm.

G1F, Q1F, M1F

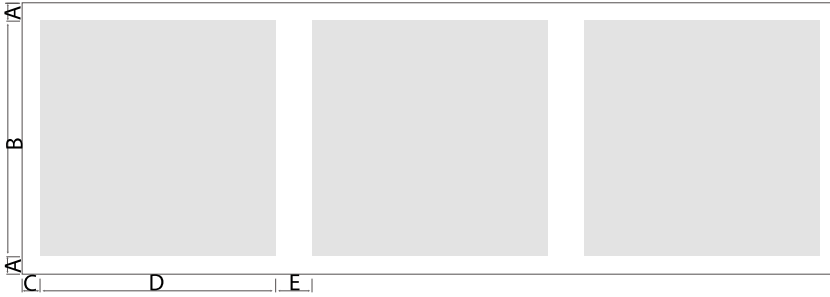

G1F, Q1F, M1F	Perforation percentage	A	B	C	D	E
Designpanel G1F	9.8%	60	780	60	780	120
Designpanel Q1F	13%	60	780	60	780	120
Designpanel M1F	9.8%	62.5	775	62.5	775	125

G2F*, Q2F, M2F

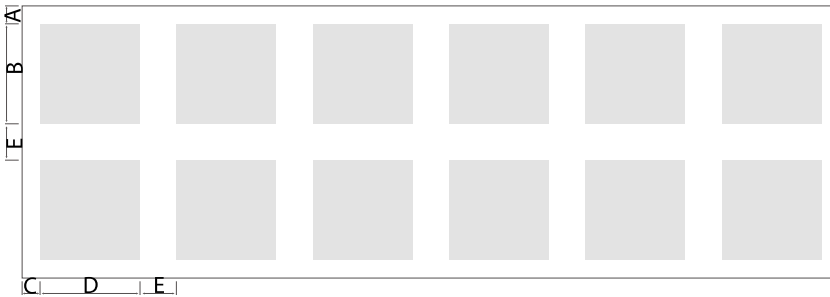

G2F, Q2F, M2F	Perforation percentage	A	B	C	D	E
Designpanel G2F	7.4%	60	330	60	330	120
Designpanel Q2F	10.2%	60	330	60	330	120
Designpanel M2F	7.1%	62.5	325	62.5	325	125

PATTERNS DESIGNPANEL 1200 X 2400

Following perforation patterns are available for Designpanel Globe, Quadril og Micro 1200 x 2400 mm.

G2F, Q2F, M2F

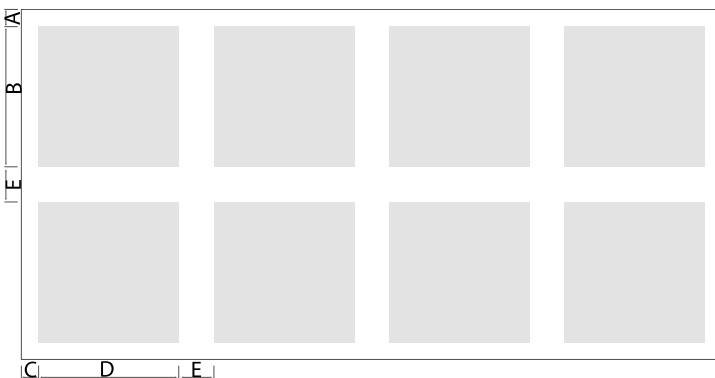

G2F, Q2F, M2F	Perforation percentage	A	B	C	D	E
Designpanel G2F	8.6%	60	480	60	480	120
Designpanel Q2F	11.6%	60	480	60	480	120
Designpanel M2F	8.4%	62.5	475	62.5	475	125

*Non standard

PATTERNS DESIGNPANEL 900 X 2400

Following perforation patterns are available for Designpanel Tangent 900 x 2400 mm.

T3L1

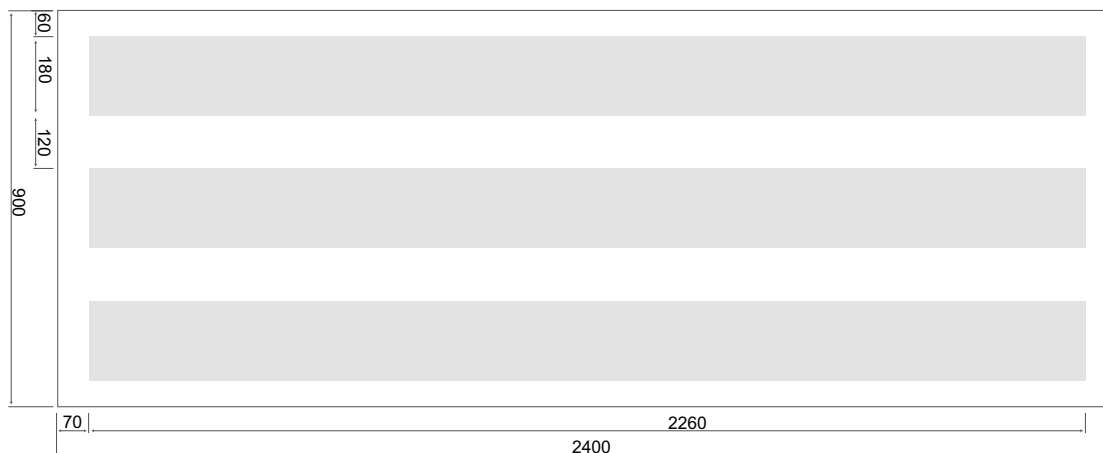

Perforation percentage

T3L1 15.8%

T3L2

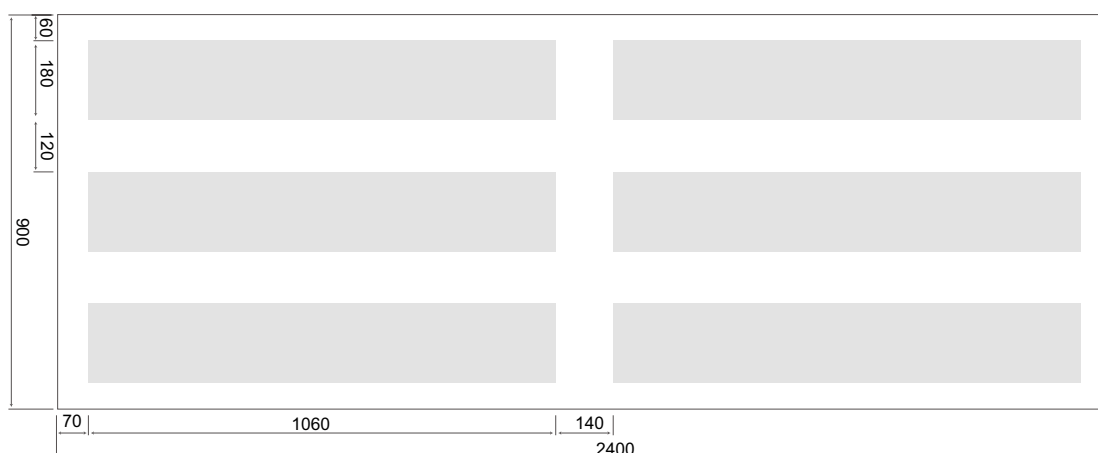

Perforation percentage

T3L2 15.0%

T3L4

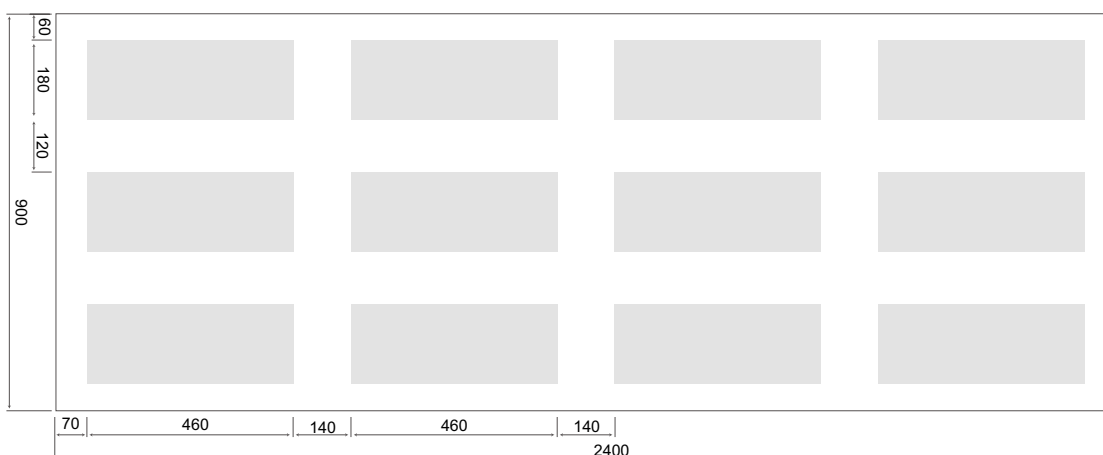

Perforation percentage

T3L4 13.3%

DID YOU KNOW THAT ...

perforated gypsum boards, in case of fire, act as a natural sprinkler in the building?

TECTOPANEL

ACOUSTICAL CEILING PANELS

Acoustic ceiling lining offering flexibility. Blank canvas providing numerous opportunities for creative design. Available in a large number of sizes. Suitable for curving on site or from factory.

ACOUSTICAL CEILING PANELS

TECTOPANEL

SIZES

400 x 600 x 9,5 mm	R
600 x 600 x 12,5 mm	G, M, T, R
600 x 2400 x 12,5 mm	R
625 x 625 x 12,5 mm	G, M, R
625 x 1250 x 12,5 mm	G, R

Other sizes on request

SURFACE

Untreated

DANISH INDOOR CLIMATE LABELLING (DIM)

Indoor value: 10 days

Particle emission: low (< 0.75 mg)

CLEANING

Dust is removed using a dry duster or vacuum cleaner. Removal of marks depends on the paint used on site, although a damp cloth using normal cleaning practices and neutral cleaning solutions is normally suitable for minor marks. In the case of stubborn marks or if in doubt refer to the paint manufacturer's recommendations.

AMBIENT CONDITIONS

The product is designed to perform under normal conditions of use. Tested at 90% RH and 30°C. The product can withstand ambient temperatures of up to 50°C.

LIGHT REFLECTION

Depends on the paint used on the site.

LOAD-BEARING CAPACITY

1 / A / No load

2 / B / No load

FIRE CLASS

A2-s1,d0

FIRE RATING

Can be used in a BD 30 construction

Class 1; K₁ 10, A2-s1,d0

ROBUSTNESS

Made of robust, glass fibre reinforced material with excellent pressure resistance and can therefore be used on walls as well as ceilings. Under normal conditions of use, the product properties are preserved and there is no decomposition of material over time.

WEIGHT

Indicative tile weight: 7.70 – 9.90 kg/m².

All according to type of perforation and thickness.



CERTIFICATES

- Declaration of Conformity (EN 14190)
- Danish Indoor Climate Labelling

ACOUSTICAL CEILING PANELS

TECTOPANEL

ACOUSTICS

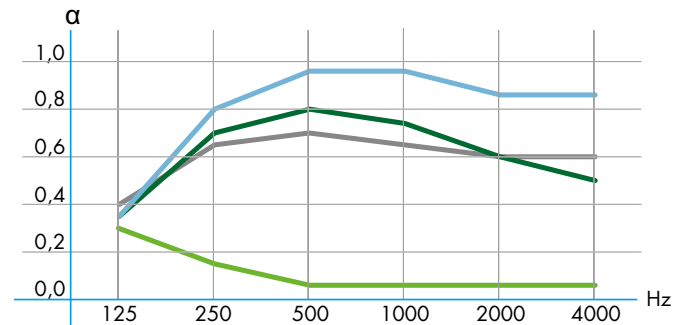

● α	0,35	0,70	0,80	0,75	0,60	0,50
● α	0,40	0,65	0,70	0,65	0,60	0,60
● α	0,35	0,70	0,95	0,95	0,85	0,85
● α	0,30	0,15	0,05	0,05	0,05	0,05

● Globe, 65 mm suspension, 50 mm mineral wool aw: 0.65, NRC: 0.70
 ● Micro, 65 mm suspension, 50 mm mineral wool aw: 0.65, NRC: 0.60
 ● Tangent, 65 mm suspension, 50 mm mineral wool aw: 0.90 NRC: 0.85
 ● Regula, 65 mm suspension, 50 mm mineral wool aw: 0.10, NRC: 0.05

For acoustic data on alternative constructions please see "Absorption Data" at knaufdanoline.com

EDGES



Edge B

(bevelled edge)

Visible joints

For Globe, Micro and Tangent





PERFORATION

Also available as Regula.

Other perforation patterns are manufactured to order.



Globe, $\text{Ø}6$ mm,
15 mm c/c
Perforation: 9-11%



Micro, 3 x 3 mm,
8.3 mm c/c
Perforation: 9.5-10.7%



Tangent, 4 x 14 mm,
10/20 mm c/c
Perforation: 21.1-21.3%

INSTALLATION GUIDE - FURRINGS OF WOOD

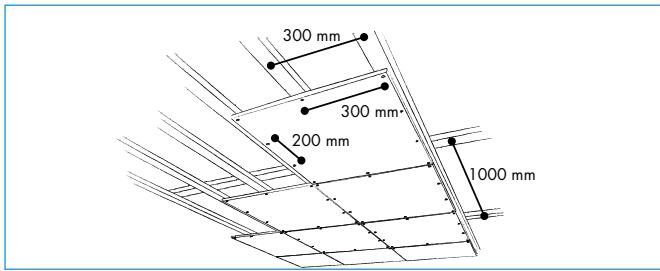
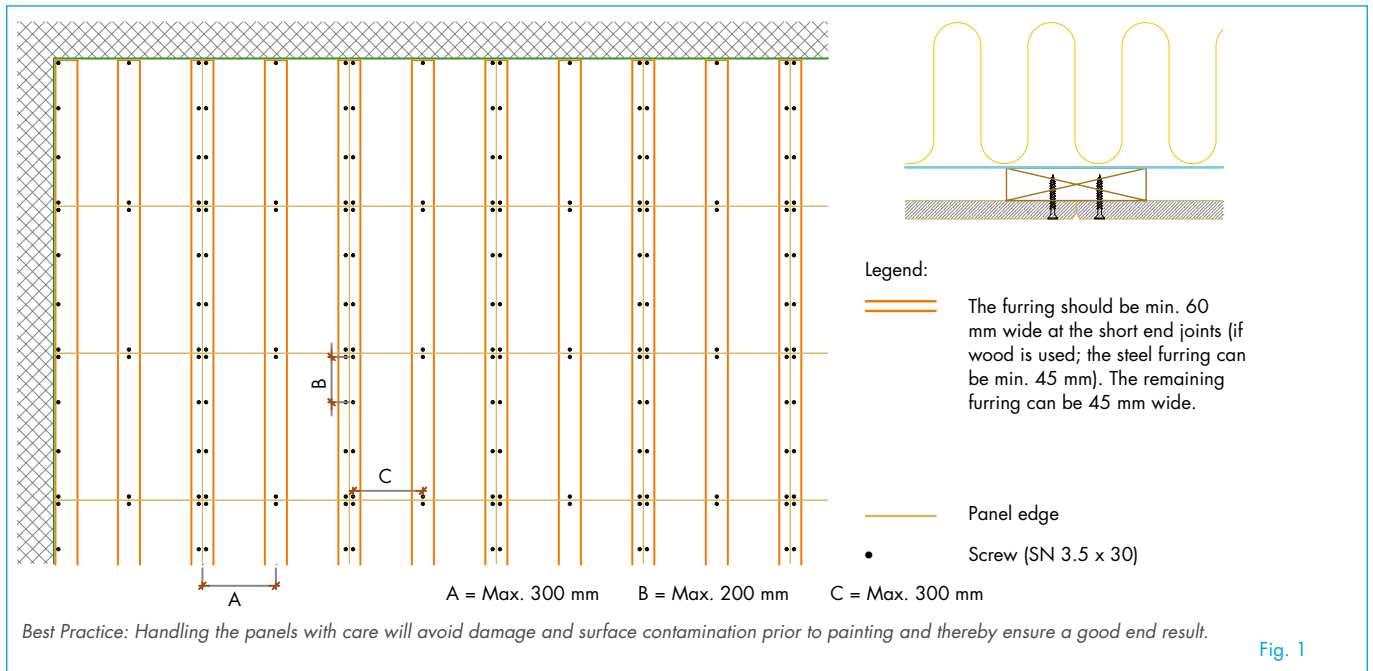

FURRING

- Furrings can be of wood or steel depending on current fire regulations.
- Furrings should be at least 45 mm in width (steel) / 60 mm in width (wood).
- Also see the sections "Fire" and "Acoustics" on next page.

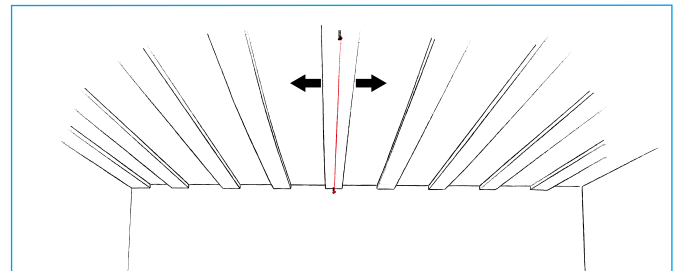

CEILING LAYOUT

- Divide the ceiling surface from the centre of the room or in accordance with the existing ceiling plans.

INSTALLATION GUIDE - FURRINGS OF STEEL (P45-S25)

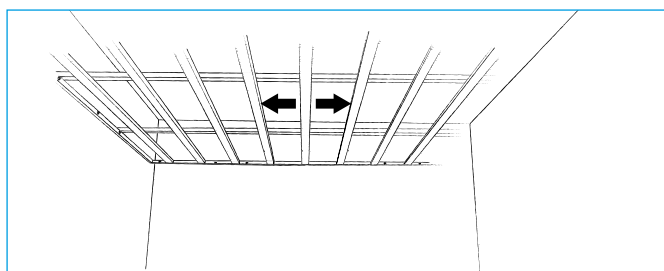
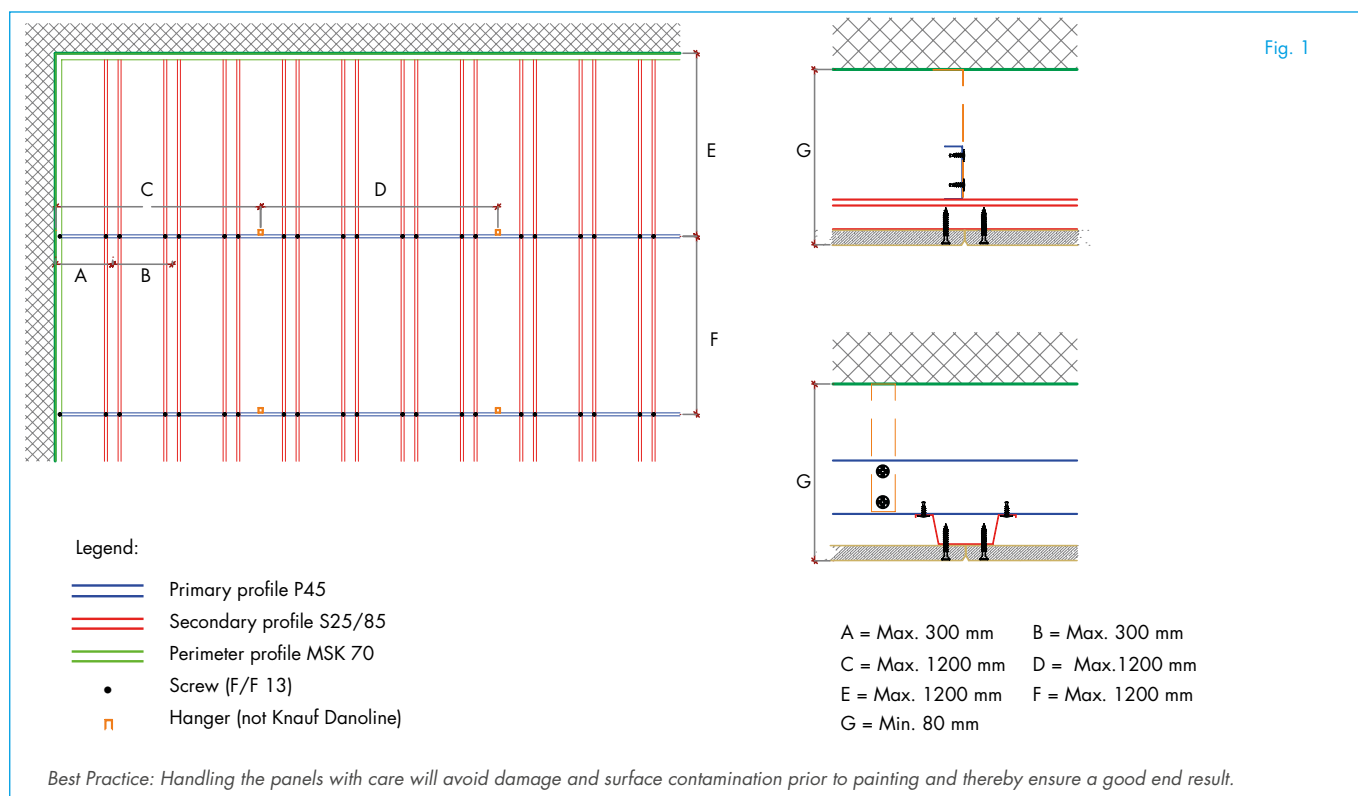

CEILING LAYOUT

- Divide the ceiling surface from the centre of the room or in accordance with the existing ceiling plans.
- Please note that expansion joints must be established on extensive ceiling surfaces at max.intervals of 15 metres in both directions.
- Where conditions indicate an increased risk of movement in a building, this must be taken into account by reducing the distance between expansion joints.

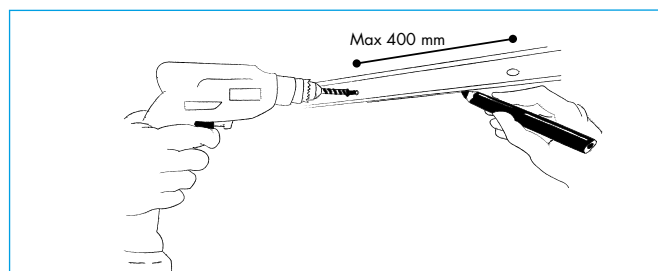

INSTALLING THE WALL PROFILE

- Mark out.
- Install the wall profile MSK70. Choose the method of fixing in accordance with the substrate.

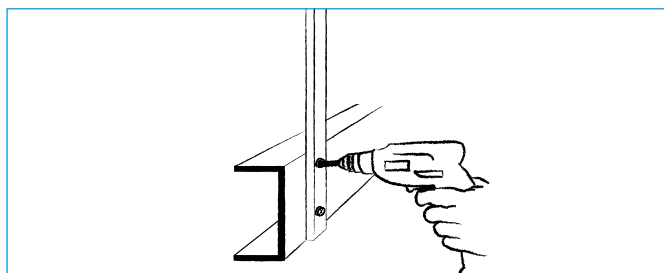

PRIMARY PROFILES/HANGERS

- Install primary profiles every 1200 mm centres (max).
- Using rigid or strap hangers. Connect hangers to primary profile with 2 screws (F/F 13).

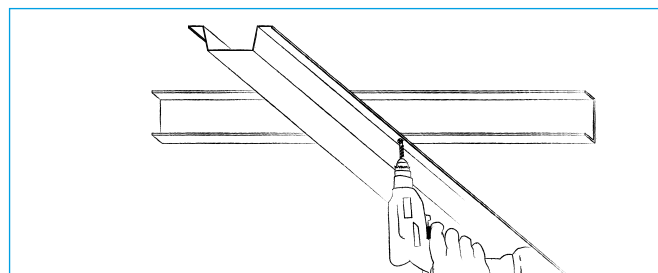

SECONDARY PROFILES

- Fix the secondary profiles to the primary profiles at every 300 mm. Use 2 screws (F/F 13) in each connection.

INSTALLATION GUIDE - FURRINGS OF STEEL (CD2)

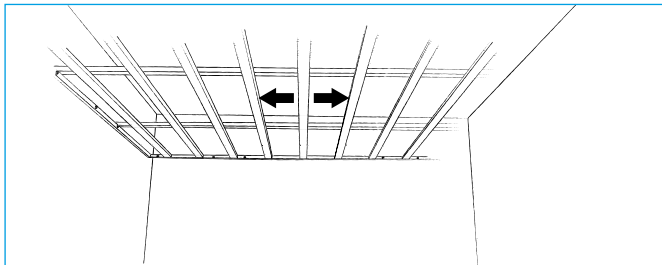
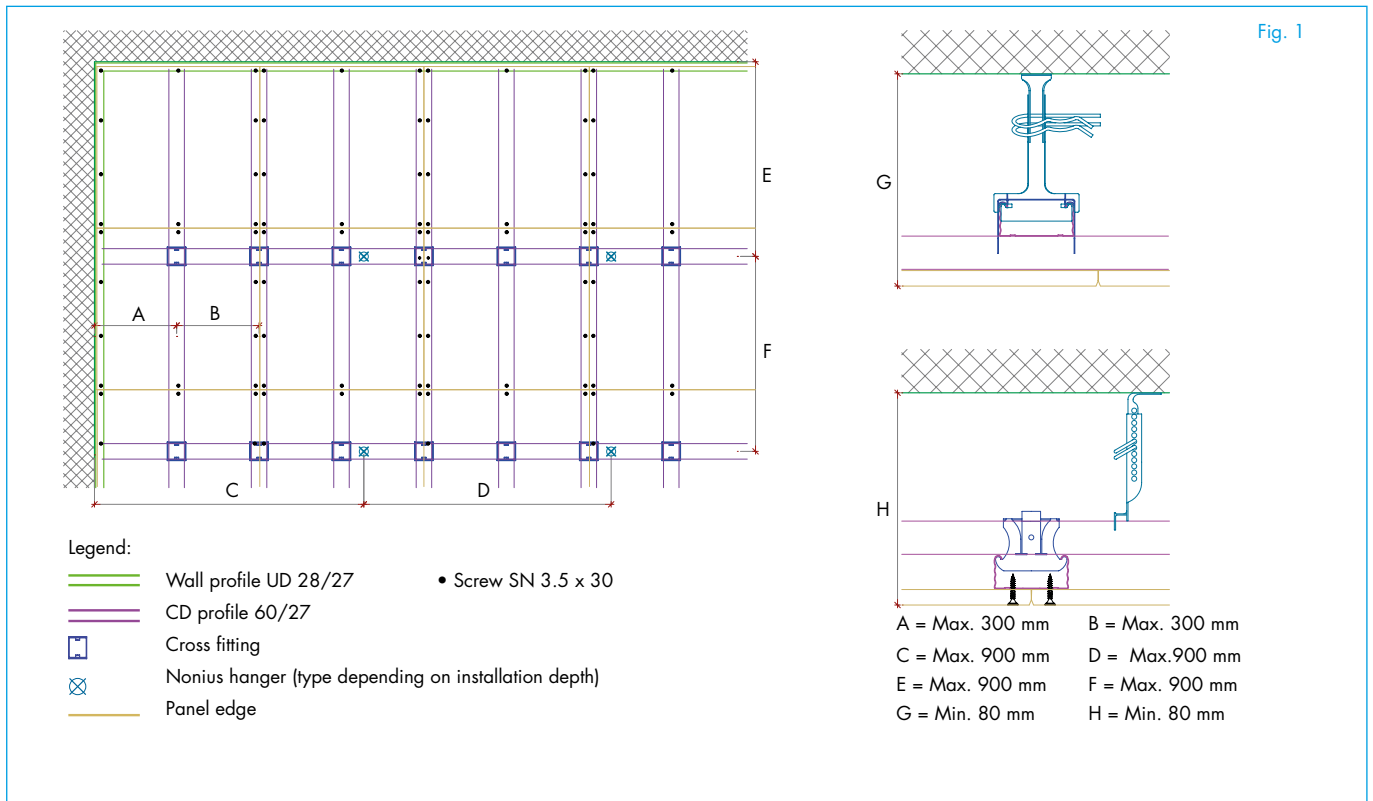

CEILING LAYOUT

- Divide the ceiling surface from the centre of the room or in accordance with the existing ceiling plans.

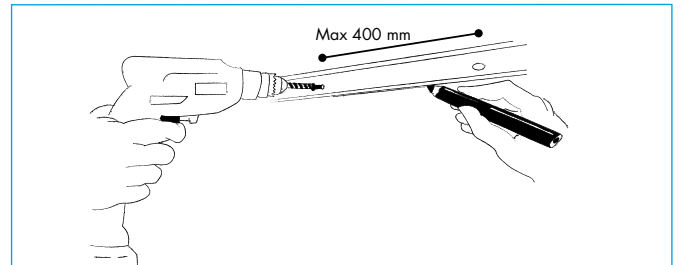

INSTALLING THE WALL PROFILE

- Mark out.
- Install the wall profile UD 28/27. Choose the method of fixing in accordance with the substrate.

INSTALLATION GUIDE - FURRINGS OF STEEL (CD2)

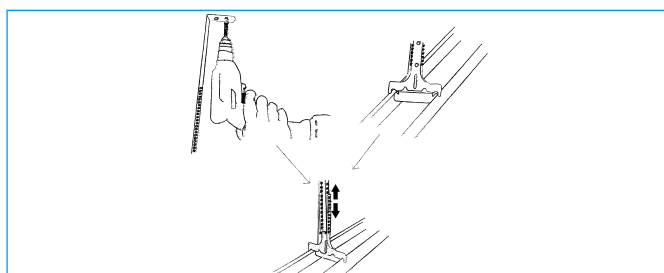

HANGERS

- Secure the upper part to the construction above it at 900 mm c/c. Choose the fixings in accordance with the substrate.
- Secure the lower part to the primary profile.

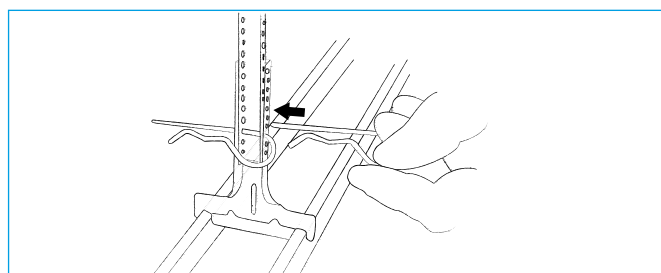

PRIMARY PROFILES

- Connect the two parts of the hangers with two split pins, one immediately above the other.

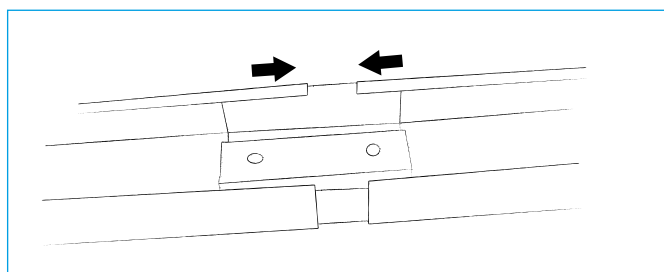

JOINING CD-PROFILES

- Join the CD profiles with the help of length connectors.

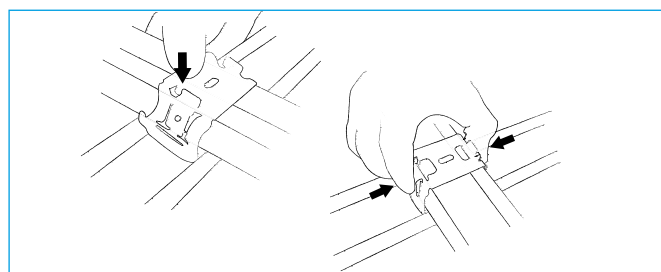

SECONDARY PROFILES

- Place a cross fitting on the primary profile.
- Press the underlying secondary profile into it.
- Adjust the locations of the secondary profiles and lock the cross fitting. See distances in figure 1.

INSTALLATION GUIDE - PANELS AND FILLING

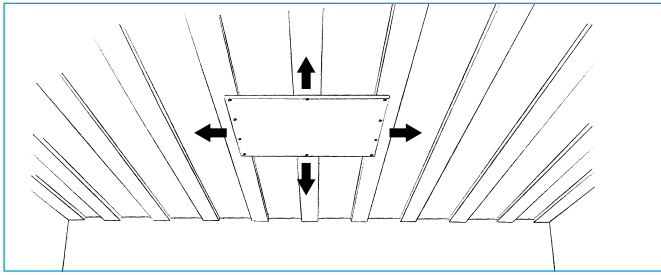

ELEMENT LAYOUT

- Install the panels beginning in the centre of the room.
- Install the first row with the help of string.

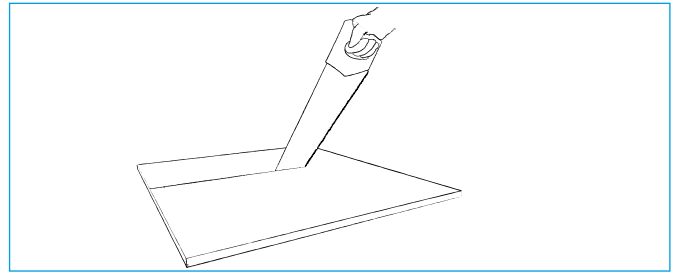

CUTTING

- Cut the elements to size from the front with a fine-toothed saw.

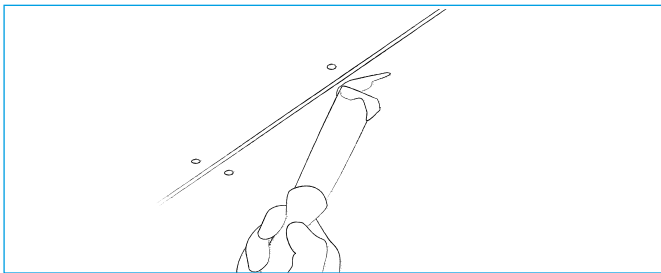

FILLING SCREW HOLES

- Check that the screws have been countersunk.
- Apply filler (Knauf Uniflott Finish or Easy Filler). Overfill slightly.
- We recommend the use of Knauf Danogips „Acoustic filling knife for holes“ in order to avoid filler getting into the perforation holes.

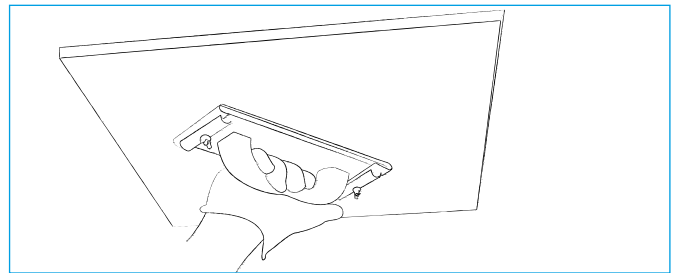

SANDING

- Make sure that the filler is completely dry.
- Sand with fine sandpaper until the surface is completely smooth. Be careful not to damage the cardboard surface.

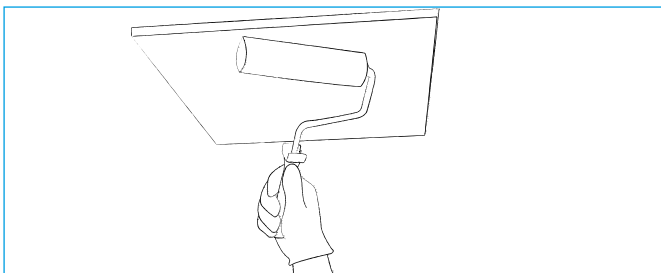

PAINTING

- Make sure that the filler is completely dry and the surface is free from dust.
- Priming should be carried out in accordance with the paint manufacturer's instructions.
- Use a fine short-haired mohair roller to apply the paint.
- Make sure that the paint is not too thick and avoid applying too much paint at a time so that it does not create a „film“ over the perforation holes.

ACOUSTICS

- A perforated gypsum panel will lose its acoustic function if the perforations are blocked (this applies to the front and back of the panel).
- Where applicable, a vapour barrier should therefore always be placed between the rafter and furrings so that it does not come into contact with the back of the perforated panel.
- When installing Tectopanel beneath a fixed ceiling it may be necessary to insert mineral wool (Knauf Danoline can offer mineral wool packed in plastic) into the cavity between the back of the panel and the fixed ceiling. This is primarily to ensure low frequency sound absorption.

FIRE

- If there is a requirement for BD30, follow the instructions for this construction.

INSTALLATION GUIDE - CURVED PANELS

Apply water on the front face and leave for 30 minutes. If necessary the panel can be covered in plastic to assist the panel in absorbing the water.

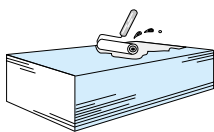

Lay the panel over a template. Secure the panel on one side of the template.

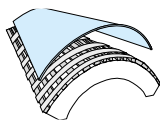

To minimize the risk of mold formation during the process, make then sure that a fast drying of the boards is present.

A good ventilation with high air exchange and relative high temperature is needed and with advantage the boards can be bended and dried out before mounting.

Press the panel against the template using a batten, moving it every 100 mm. Secure the panel on the other side of the template. Make sure that the panel is fully dry before mounting or closing the construction.

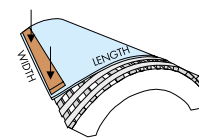

DETAILS



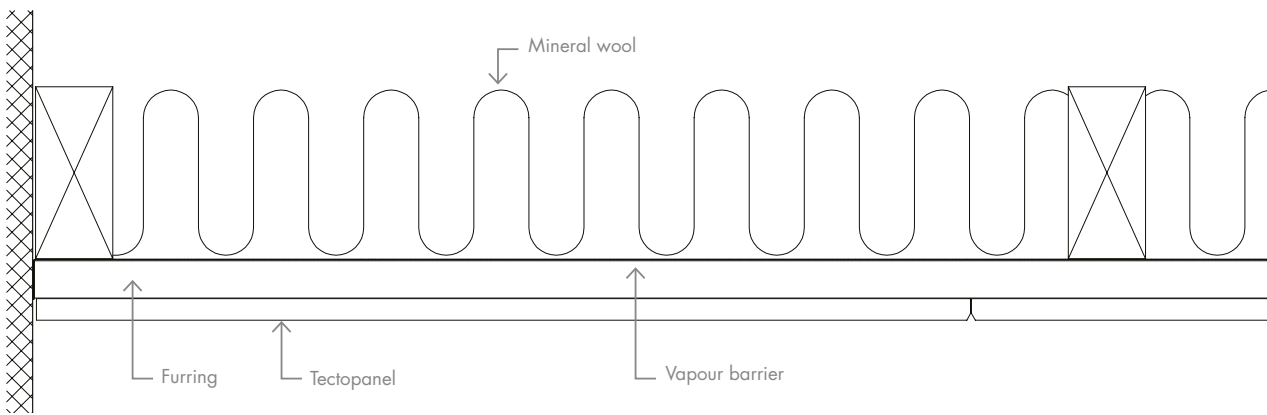
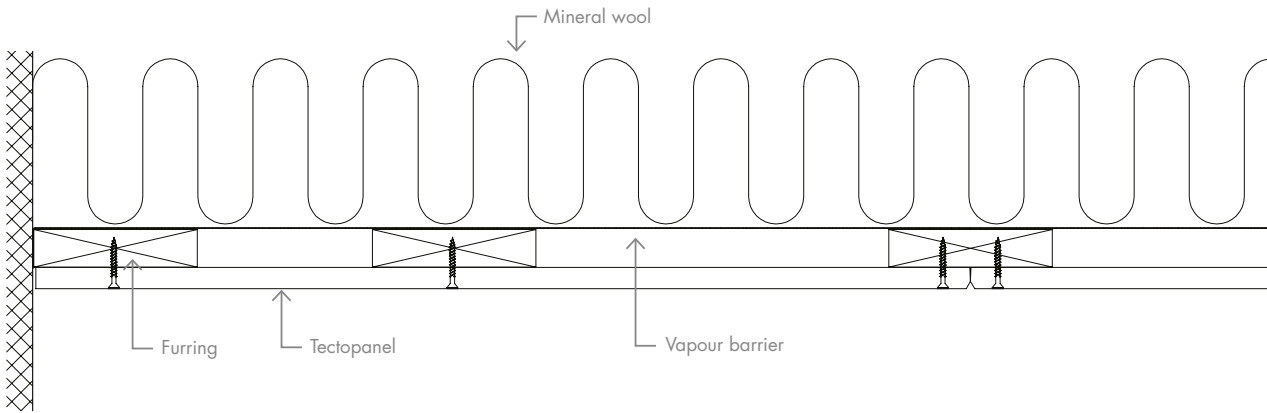



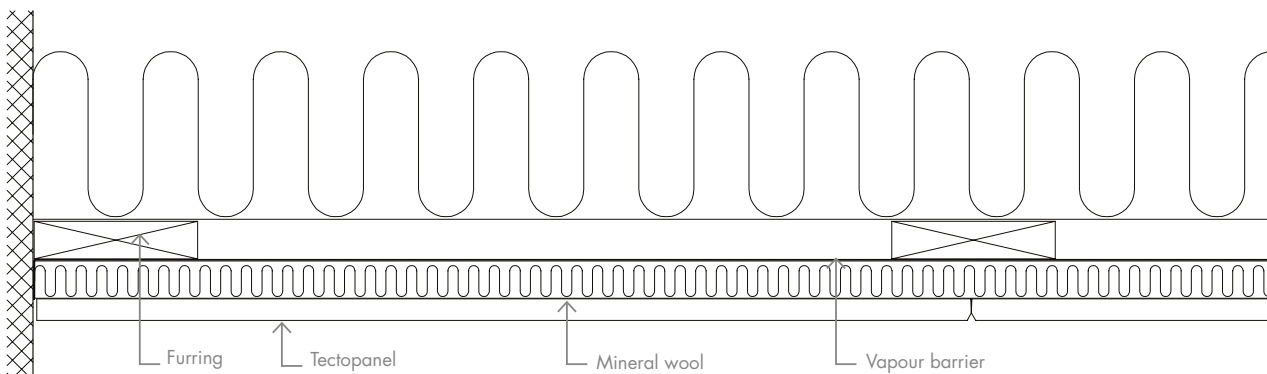
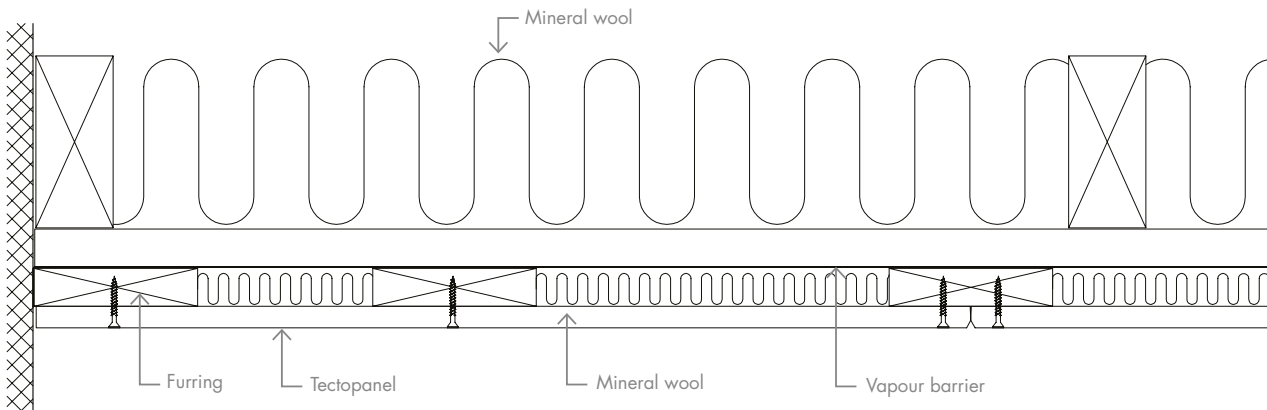



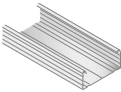



TECTOPANEL WITH 1 LAYER FURRING

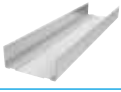

TECTOPANEL WITH CROSS-FURRING



ACCESSORIES

	PRODUCT NAME		SAP NO.	W x L x H (mm)	Consumption per. m ²
Accessories for system CD2	Primary / secondary CD 60/27-profile		3294	60 x 4000 x 27	4.6 m
	Wall angle UD 28/27		181589	28 x 3000 x 27	1.0*
	Length connector CD 60/27		181080	59 x 80 x 28	1.1 pcs.
	Cross-fitting		3446	-	3.3 pcs.
	Split pin for hanger		198907	-	2.6 pcs.
	Nonius hanger lower		198904	-	1.3 pcs.
	Nonius hanger upper 85mm		198905	125 - 185	} 1.3 pcs.
	Nonius hanger upper 135mm		198906	135 - 235	
	Nonius hanger upper 235mm		198923	235 - 340	
	Nonius hanger upper 340mm		198924	340 - 440	
	Nonius hanger upper 440mm		198925	440 - 540	
	Nonius hanger upper 540mm		198926	540 - 640	
	Nonius hanger upper 640mm		198927	640 - 740	
	Nonius hanger upper 740mm		198928	740 - 840	
Nonius hanger upper 840mm	198929		840 - 940		
Nonius hanger upper 940mm	198930		940 - 1040		
Accessories for system P45-S25	MSK 70 Perimeter profile		181029 181030	2500 3600	1.0 m*
	P45 Primary profile		181684	3600	0.85 m
	S25/85 Secondary profile		181685	3800	3.6 m
	F/F13 Screw		2017	13	8 pcs.
	Screw SN3.5x30		3503	3,5 x 30	30 pcs.
	Joint Filler - Easy Filler Light		235309	-	-
	Unflott Finish		129801	8 kg	≤ 0.1 kg
	Filling knife		73962	-	-

*Depending on room size.

DID YOU KNOW THAT ...

thanks to their robustness, perforated gypsum boards can be fully integrated with the wall construction, thereby creating a uniform wall surface with acoustic performance?

CONTRAPANEL

ACOUSTICAL CEILING PANELS

Acoustical performance and impact resistance in one solution. Acoustic ceiling lining with a distinct unified look. Tested in accordance with DIN 18 032 (EN 13 964) - the toughest requirements for impact resistance. Foil-covered surface – easy to clean.

ACOUSTICAL CEILING PANELS

CONTRAPANEL

SIZES

600 x 1200 x 12.5 mm

SURFACE

Foil-covered with pre-impregnated white paper
Gloss 10

Tested for chemical resistance in accordance with
DIN 68 861, FIRA BS 3962 and NEMA LD-3-1991

DANISH INDOOR CLIMATE LABELLING (DIM)

Indoor value: 10 days

Particle emission: low (< 0.75 mg)

CLEANING

Dust is removed using a dry duster or vacuum cleaner. Marks can be removed with a damp cloth using normal cleaning practices and neutral cleaning solutions.

AMBIENT CONDITIONS

The product is designed to perform under normal conditions of use. Tested at 90% RH and 30°C. The product can withstand ambient temperatures of up to 50°C.

LIGHT REFLECTION

Globe: 74.1%

Regula: 86.3%

LOAD-BEARING CAPACITY

1 / B / No load

2 / B / 30N

FIRE CLASS

B-s1,d0

FIRE RATING

Class 1; K₁ 10, B-s1,d0

ROBUSTNESS

Durable and dirt resistant surface. Product made of robust, glass fibre reinforced material with excellent pressure resistance and can therefore be used on walls as well as ceilings. Under normal conditions of use, the product properties are preserved and there is no decomposition of material over time.

WEIGHT

Indicative tile weight: 8.50 – 9.40 kg/m².

All according to type of perforation and thickness.



CERTIFICATES

- DIN 4102-2 Fire Classification
- MPA certificate - impact resistance
- Declaration of Conformity (EN 14190)
- Danish Indoor Climate Labelling

ACOUSTICAL CEILING PANELS CONTRAPANEL

ACOUSTICS

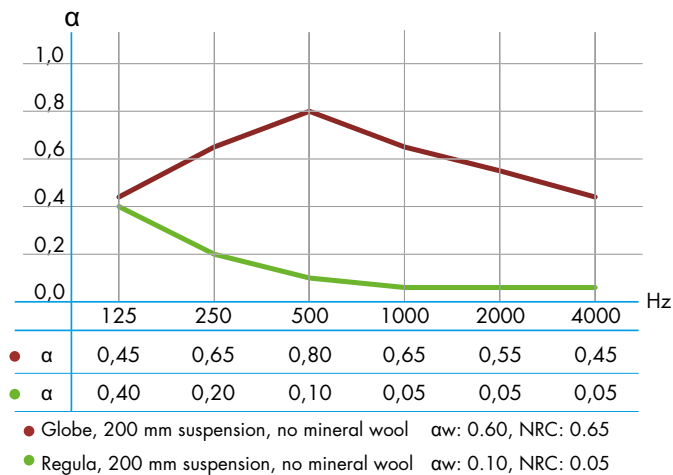

For acoustic data on alternative constructions please see "Absorption Data" at knaufdanoline.com

IMPACT RESISTANCE

Contrapanel is especially designed to meet the tough requirements for ceiling linings in facilities used intensively for sport, such as sport halls and gymnasiums.

The panels show no visible deformation after the tests carried out in accordance with EN 13964 or DIN 18032.

Contrapanel meets the toughest class 1 requirements in accordance with EN 13964 for impact resistant ceiling linings making the product ideal even for handball or hockey courts.

EDGES



Edge B
(bevelled edge)
Visible joints
For Globe





PERFORATION

Also available as Regula.



Globe, Ø6 mm,
15 mm c/c
Perforation G1F: 10.2%

INSTALLATION GUIDE

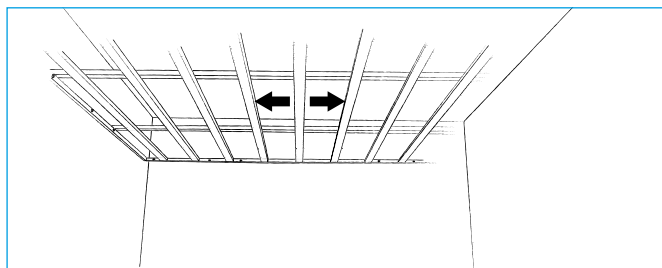
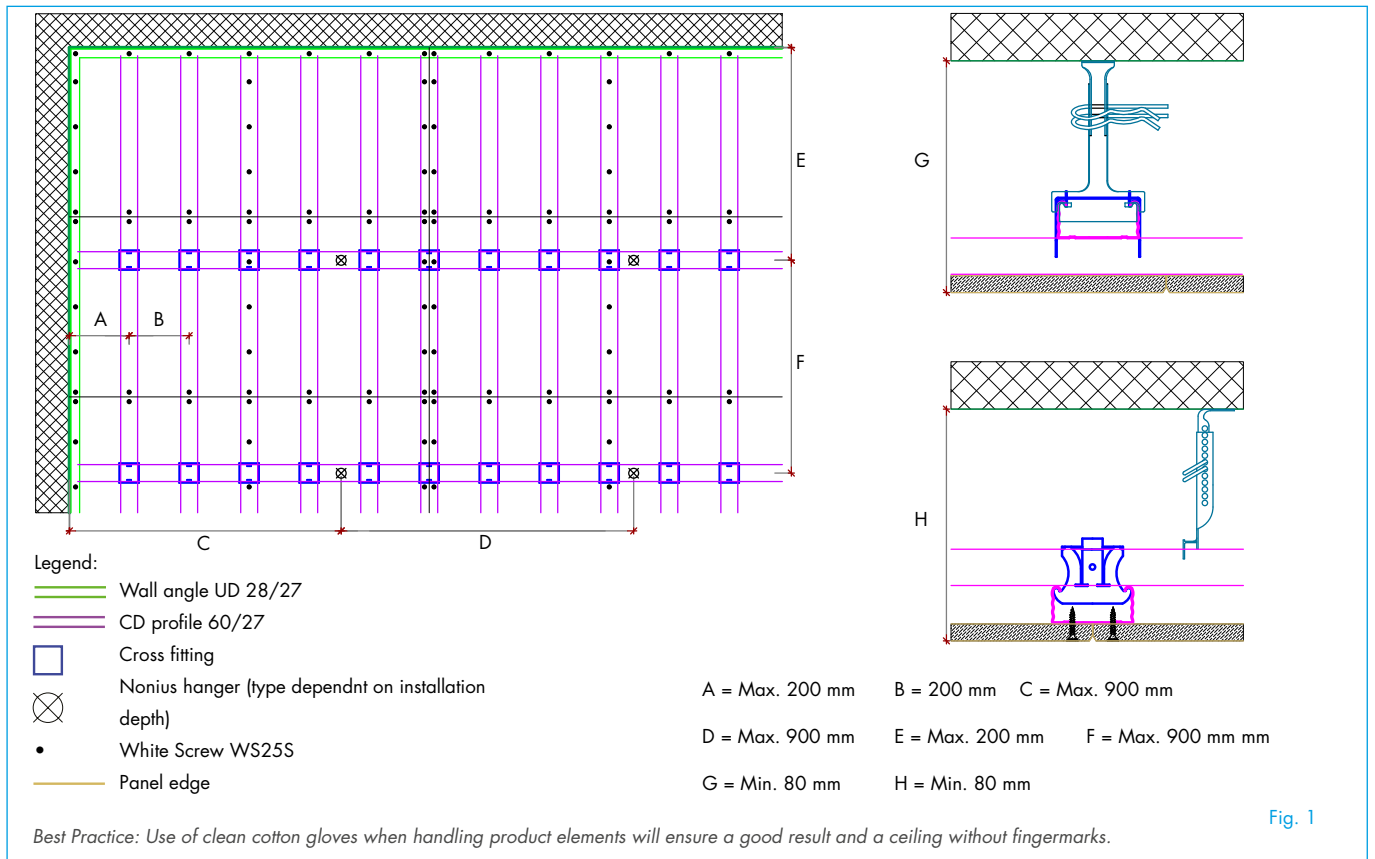

CEILING LAYOUT

- Divide the ceiling surface from the centre of the room or in accordance with the existing ceiling plans.

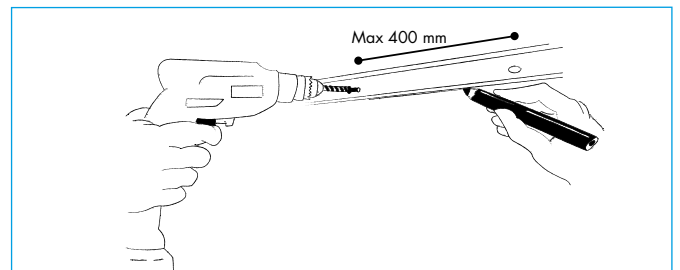

INSTALLING THE WALL PROFILE

- Mark out.
- Install UD profile 28/27 with a max. distance between screws of 400 mm. Choose the fixings in accordance with the substrate.

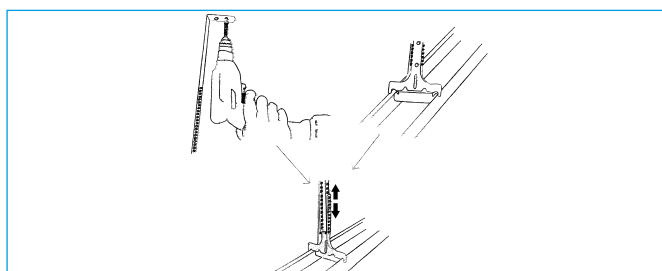

HANGERS

- Secure the upper part to the construction above it at 900 mm c/c.
- Secure the lower part to the primary profile.

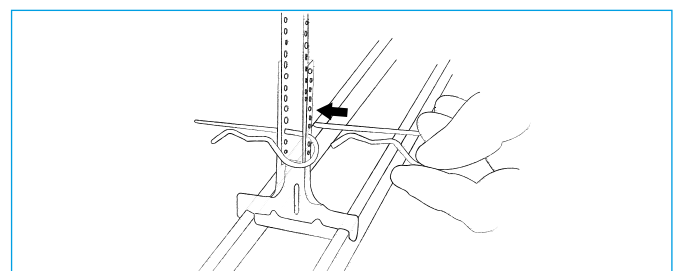

PRIMARY PROFILES

- Connect the two parts of the hangers with two split pins, one immediately above the other.
- Place the primary profiles at a max. distance of 900 mm from each other.

INSTALLATION GUIDE

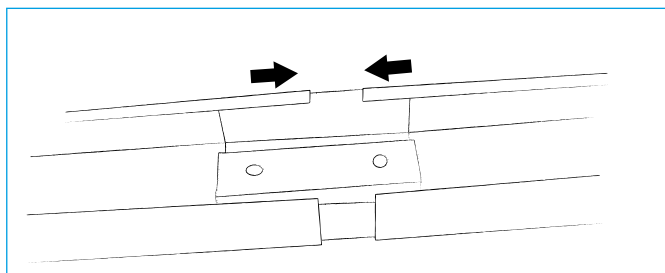

JOINING CD PROFILES

- Join the CD profiles (both primary and secondary profiles) with the help of length connectors.
- The joints can be made as butt joints.

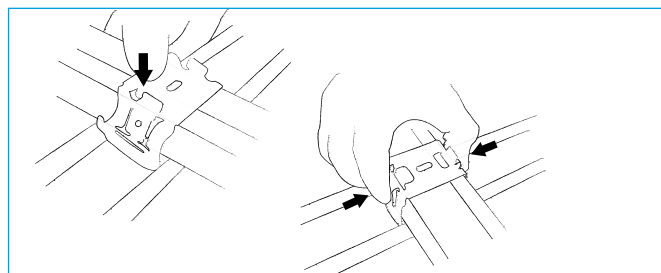

SECONDARY PROFILES

- Place a cross fitting on the primary profile.
- Press the underlying secondary profile into it.
- Place secondary profiles at 200 mm c/c.
- Adjust the locations of the secondary profiles and lock the cross fitting.

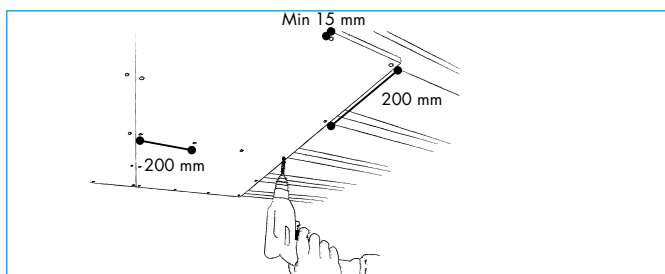

INSTALLATION

- Always wear cotton gloves when handling the panels.
- Mark the position of screws on the Contrapanel. Use the supplied template for this if necessary.
- Install the elements from the centre. Install the first row with the help of string.
- Secure screws min. 15 mm from the edge of the element at 200 mm c/c.
- Use white screws.

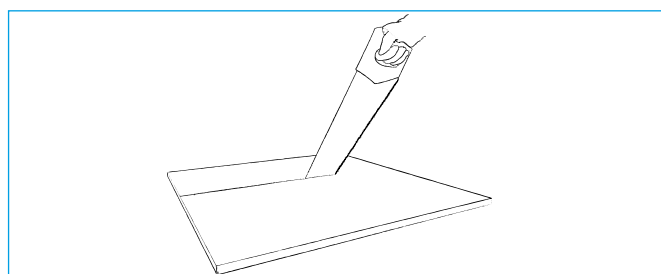

CUTTING





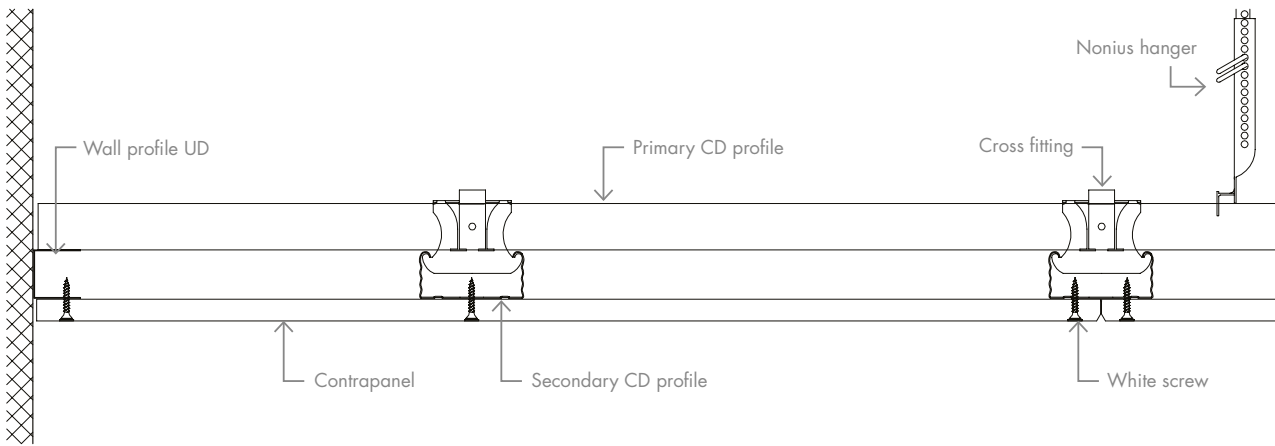
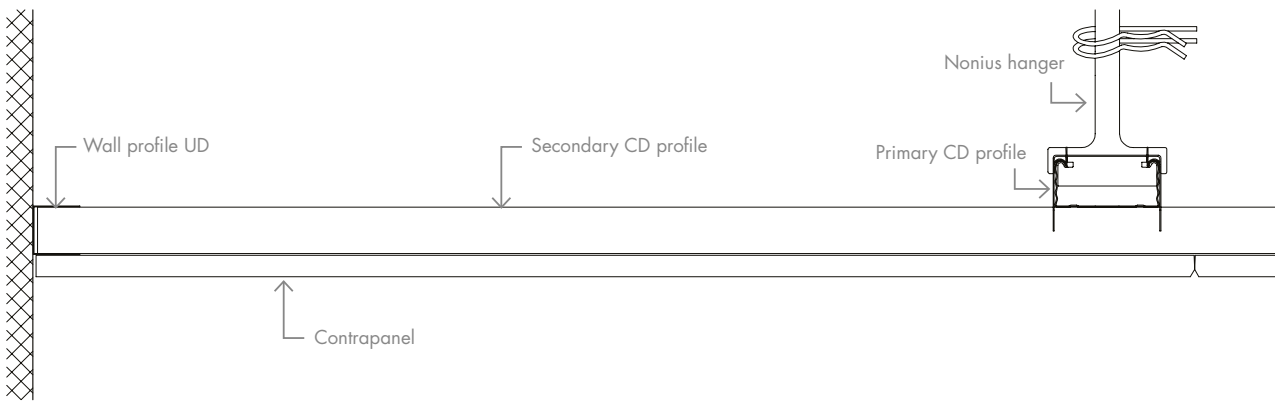

- Cut the elements to size from the front with a fine-toothed saw.

DETAILS

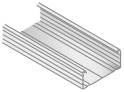
CONTRAPANEL ON CD2 SYSTEM

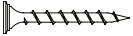
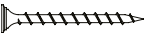
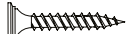
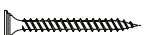

ACCESSORIES

PRODUCT NAME		SAP NO.	W x L x H (mm)
Primary / secondary CD 60/27-profile		3294	60 x 4000 x 27
Wall angle UD 28/27		181589	28 x 3000 x 27
Length connector CD 60/27		181080	59 x 80 x 28
Cross-fitting		3446	-
Split pin for hanger		198907	-
Nonius hanger lower		198904	-
Nonius hanger upper 85mm		198905	125 - 185
Nonius hanger upper 135mm		198906	135 - 235
Nonius hanger upper 235mm		198923	235 - 340
Nonius hanger upper 340mm		198924	340 - 440
Nonius hanger upper 440mm		198925	440 - 540
Nonius hanger upper 540mm		198926	540 - 640
Nonius hanger upper 640mm		198927	640 - 740
Nonius hanger upper 740mm		198928	740 - 840
Nonius hanger upper 840mm		198929	840 - 940
Nonius hanger upper 940mm		198930	940 - 1040
White painted screw WS32T - for 1 layer on wood		198794	32
White painted screw no 408 - for 2 layers on wood		199109	42
White painted screw WS25S - for 1 layer on steel		219774	25
White painted screw WS38S - for 2 layers on steel		219780	38

DID YOU KNOW THAT ...

our product range includes a special purpose ceiling and wall panel that meets the toughest impact resistance requirements and can be used in sports halls, gymnasiums and other facilities used intensively for sport?

DANOPANEL

ACOUSTICAL CEILING PANELS

Acoustic ceiling lining with a distinct unified look. Pre-painted surface and concealed fixings offering a quick and easy ceiling solution that requires no filling or painting.

ACOUSTICAL CEILING PANELS

DANOPANEL

SIZES

600 x 600 x 12.5 mm

SURFACE

Standard white painted surface
(closest match RAL 9003, gloss 5)
Other colours available on request

DANISH INDOOR CLIMATE LABELLING (DIM)

Indoor value: 10 days
Particle emission: low (< 0.75 mg)

CLEANING

Dust is removed using a dry duster or vacuum cleaner. Marks can be removed with a damp cloth using normal cleaning practices and neutral cleaning solutions.

AMBIENT CONDITIONS

The product is designed to perform under normal conditions of use. Tested at 90% RH and 30°C. The product can withstand ambient temperatures of up to 50°C.

LIGHT REFLECTION

Globe: 72.8%
Micro: 72.1%
Regula: 82.6%

LOAD BEARING CAPACITY

1 / A / No load
2 / B / No load

FIRE CLASS

A2-s1,d0

FIRE RATING

Can be used in a BD 30 construction
Class 1; K₁ 10, A2-s1,d0

ROBUSTNESS

Made of robust, glass fibre reinforced material with excellent pressure resistance. Under normal conditions of use, the product properties are preserved and there is no decomposition of material over time.

WEIGHT

Indicative tile weight: 8.50 – 9.40 kg/m².
All according to type of perforation and thickness.



CERTIFICATES

- Declaration of Conformity (EN 14190)
- Danish Indoor Climate Labelling

ACOUSTICAL CEILING PANELS

DANOPANEL

ACOUSTICS

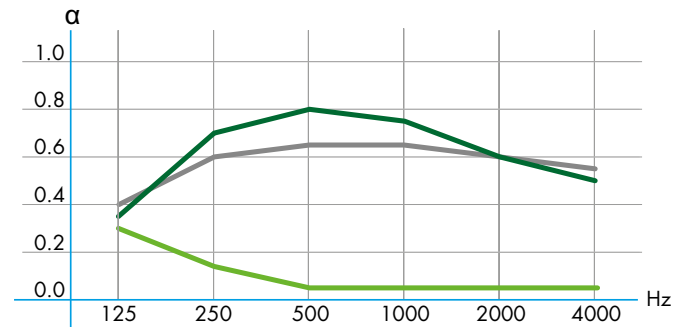

● α	0.35	0.70	0.80	0.75	0.60	0.50
● α	0.40	0.60	0.65	0.65	0.60	0.55
● α	0.30	0.15	0.05	0.05	0.05	0.05
● Globe, 65 mm suspension, 50 mm mineral wool						aw: 0.65, NRC: 0.70
● Micro, 65 mm suspension, 50 mm mineral wool						aw: 0.65, NRC: 0.60
● Regula, 65 mm suspension, 50 mm mineral wool						aw: 0.10, NRC: 0.05

EDGES



Edge B

(bevelled edge)

Visible joints

For Globe, Micro and Tangent

For acoustic data on alternative constructions please see "Absorption Data" at knaufdanoline.com



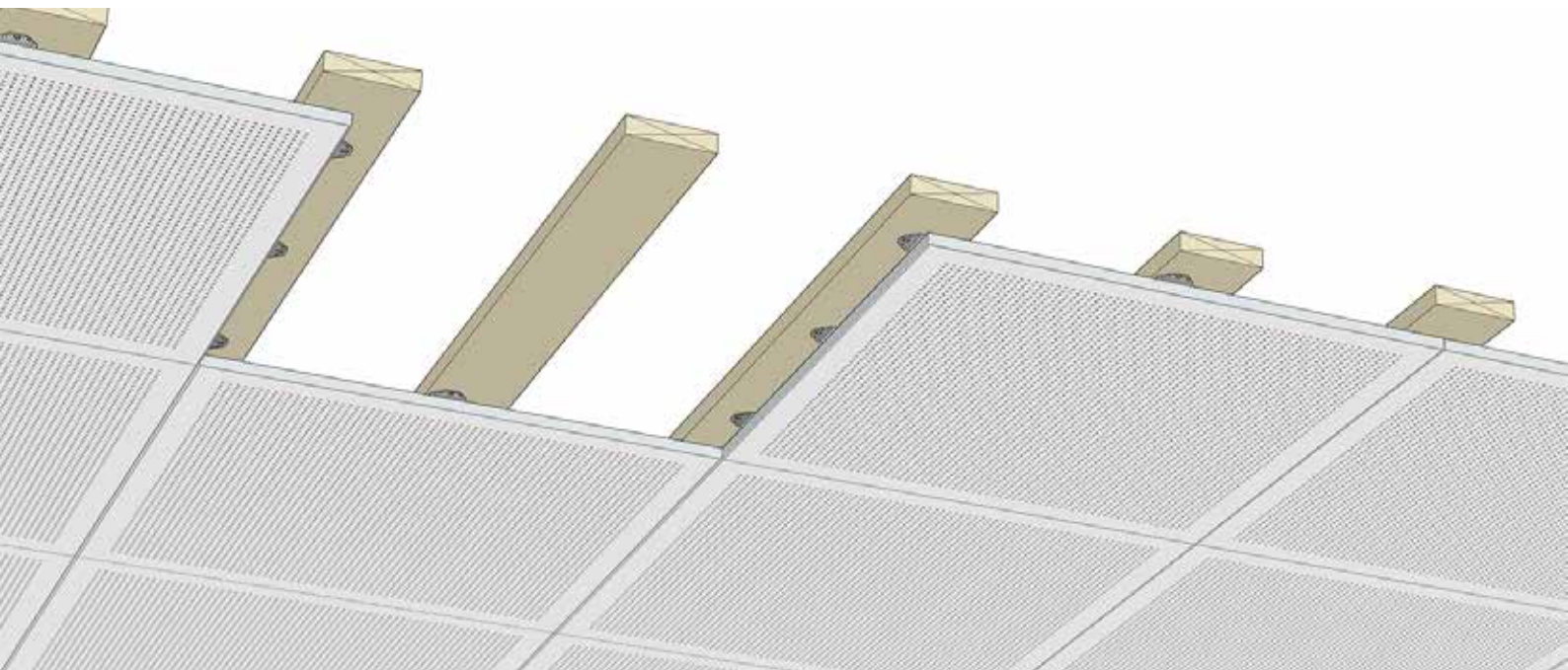

PERFORATION

Also available as Regula.

Other perforation patterns are manufactured to order.



Globe, Ø6 mm,
15 mm c/c
Perforation: 10.2%



Micro, 3 x 3 mm,
8.3 mm c/c
Perforation: 10.2%

INSTALLATION GUIDE

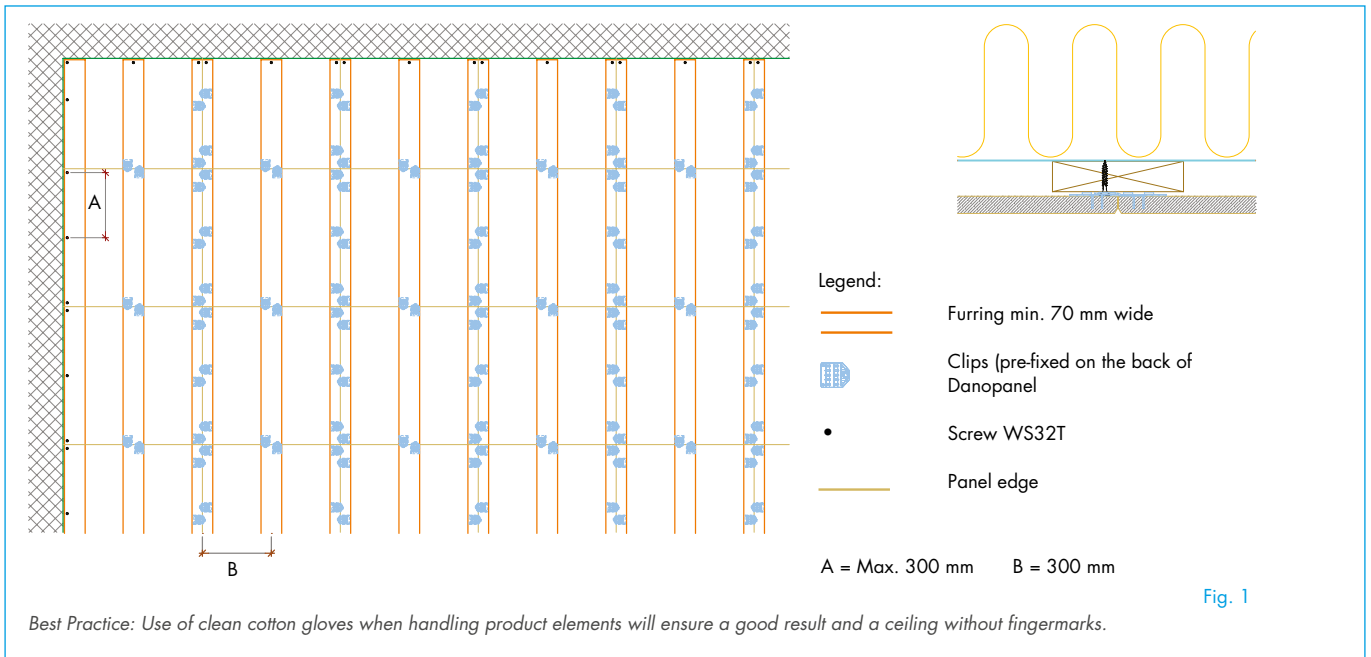
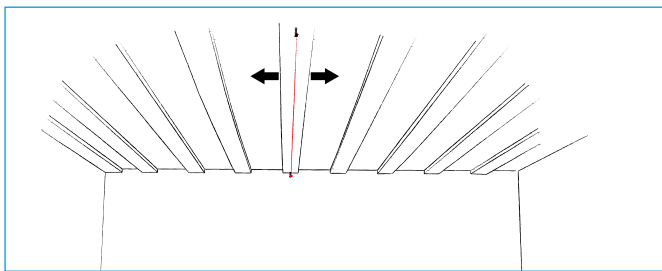
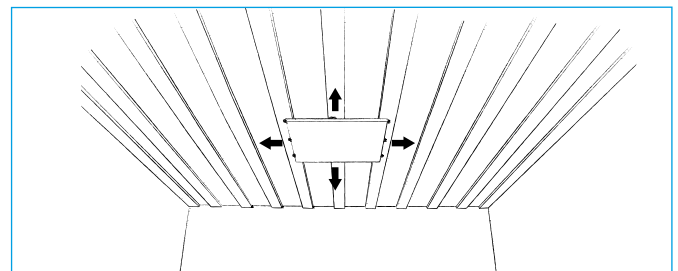

Fig. 1



CEILING LAYOUT

- Divide the ceiling surface from the centre of the room or in accordance with the existing ceiling plans.
- The wooden battens must be at least 70 mm in width with c/c of 300 mm.
- The actual ceiling construction should be determined by the local building regulations.



ELEMENT LAYOUT

- Always wear cotton gloves when handling panels.
- Install the elements beginning in the centre of the room.
- Install the first row with the help of string.

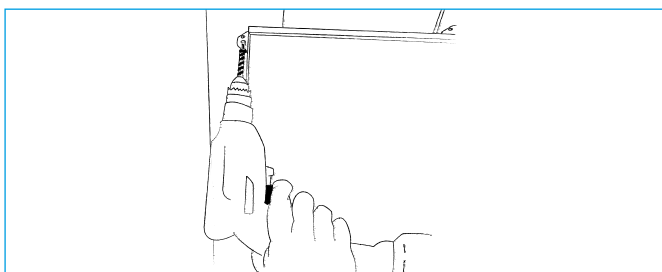

FIXING

- Secure the elements by tightening the screws through the holes in the metal clips. Use for instance screw RA25 or TA35.
- It is important that screws are vertical so that their heads take up as little space as possible.

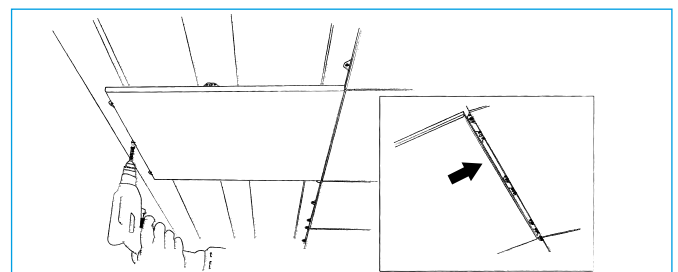

INSTALLATION OF FOLLOWING ELEMENTS

- Install the next elements by sliding the metal clips behind the preceding panel(s) and tightening the screws through the holes in the free metal clips.

INSTALLATION GUIDE

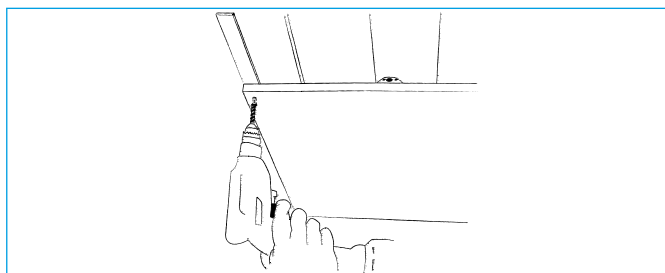

FINISHING ELEMENTS

- Secure the last row directly through the panels using white screws WS32T.
- Install additional battens to compensate for the thickness of the metal clips.
- Installation can be completed with an underlying shadow line trim. White screws can be used to secure the final panel or screw heads can subsequently be filled, sanded and painted.

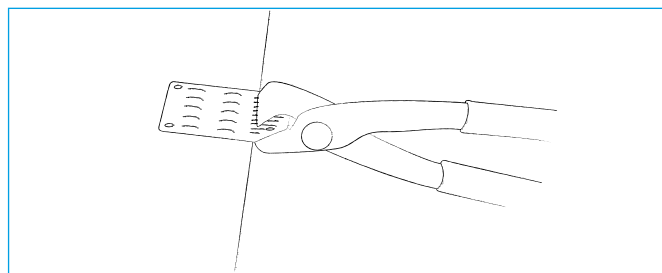

CUTTING

- Cut the elements to size from the front with a fine-toothed saw.
- If metal clips have been installed in the place where the element is to be cut, they must be removed first.
- Grip the clips with a pair of pliers and twist it off gently.
- A new metal clip can be pressed into position with a clip mounting tool available from Knauf Danoline.

ACOUSTICS

- A perforated gypsum panel will lose its acoustic function if the perforations are blocked (this applies to the front and back of the panel).
- Where applicable, a vapour barrier should therefore always be placed between the rafter and battens so that it does not come into contact with the back of the perforated panel.
- When installing a ceiling beneath a fixed surface it may be necessary to insert mineral wool (Knauf Danoline can offer mineral wool packed in plastic) into the cavity between the back of the panel and the fixed ceiling. This is primarily to ensure low frequency sound absorption.
- A perforated gypsum panel is dependent on an acoustic cavity behind it in order to achieve its acoustic properties.

DETAILS

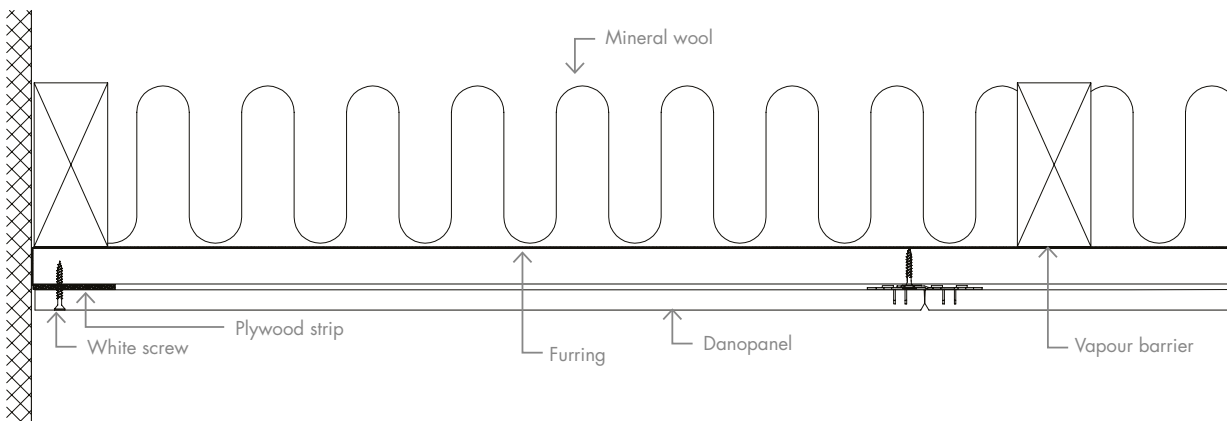
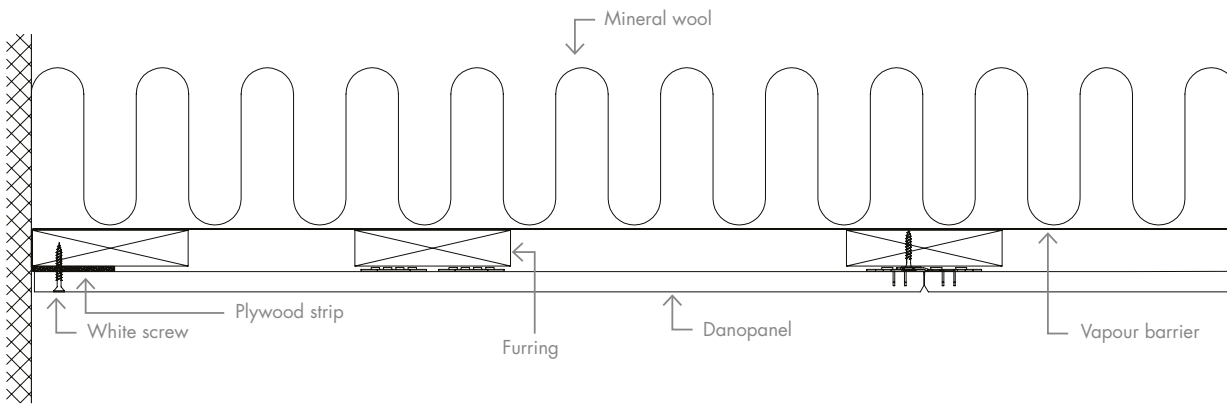

DANOPANEL ON 1 LAYER FURRING

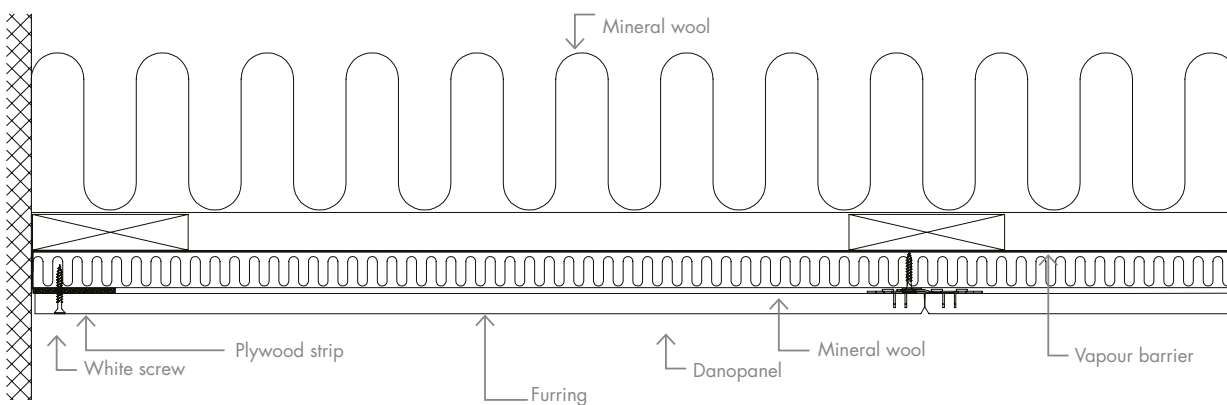
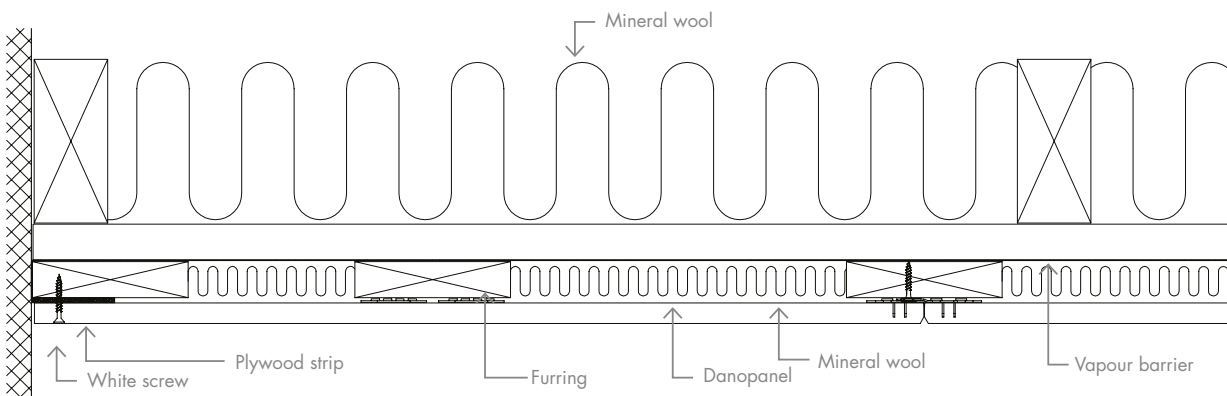

DANOPANEL ON CROSS-FURRING

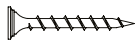
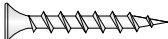

ACCESSORIES

PRODUCT NAME		SAP NO.	W x L x H (mm)
White painted screw WS32T		198794	32
Screw TA35 for plasterboards mounted on wood		181354	L: 35 mm / 1.000 pcs.
Screw RA35 for plasterboards mounted on steel		181342	L: 35 mm / 1.000 pcs.
Clips BE 13		198368	40 x 55 x 1/10

DID YOU KNOW THAT

Knauf Danoline product range includes a hygiene ceiling that is clean room certified and can be used in laboratories and other premises with high infection control requirements?

SOLOPANEL

ACOUSTICAL CEILING PANELS

Continuous perforations to the edge offering a fluid, monolithic look. A choice of seamless or discreet joints. Acoustic gypsum lining for ceiling surfaces.

ACOUSTICAL CEILING PANELS

SOLOPANEL

SURFACE

Untreated

DANISH INDOOR CLIMATE LABELLING (DIM)

Indoor value: 10 days

Particle emission: low (< 0.75 mg)

CLEANING

Dust is removed using a dry duster or vacuum cleaner. Removal of marks depends on the paint used on site, although a damp cloth using normal cleaning practices and neutral cleaning solutions is normally suitable for minor marks. In the case of stubborn marks or if in doubt refer to the paint manufacturer's recommendations.

LIGHT REFLECTION

Depends on the paint used on site.

AMBIENT CONDITIONS

The product is designed to perform under normal conditions of use. Tested at 90% RH and 30°C. The product can withstand ambient temperatures of up to 50°C.

LOAD-BEARING CAPACITY

2 / A / No load

2 / B / 30N

FIRE CLASS

A2-s1,d0

ROBUSTNESS

Made of robust, glass fibre reinforced material with excellent pressure resistance and can therefore be used on walls as well as ceilings. Under normal conditions of use, the product properties are preserved and there is no decomposition of material over time.

WEIGHT

Indicative tile weight: 8.30 – 9.00 kg/m².

All according to type of perforation and thickness.



CERTIFICATES

- Declaration of Conformity (EN 14190)
- Danish Indoor Climate Labelling

ACOUSTICAL CEILING PANELS SOLOPANEL

ACOUSTICS

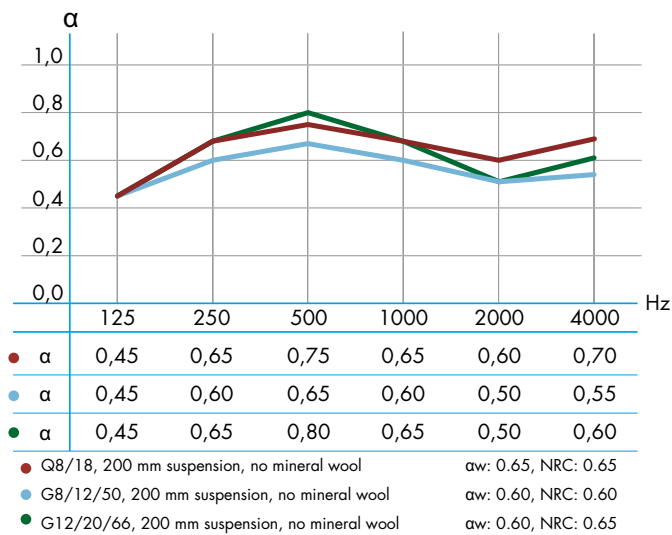
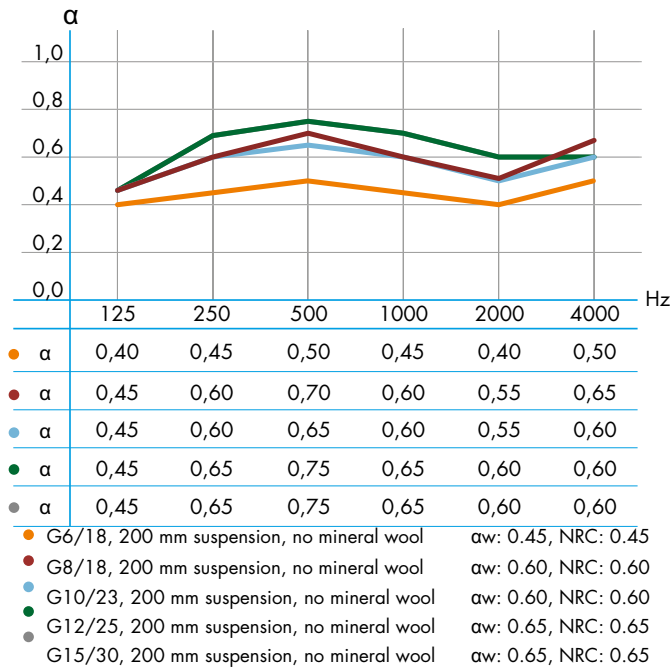

For acoustic data on alternative constructions please see "Absorption Data" at knaufdanoline.com

EDGES



Edge SK

No visible joints



Edge UFF

No visible joints



Edge MF

Discreet joint





PERFORATION

PERFORATION TYPE	PERFORATION PERCENTAGE	EDGE UFF SIZES
G 6/18	8.7 %	1188 x 1998 mm
G 8/18	15.5 %	1188 x 1998 mm
G 10/23	14.8 %	1196 x 2001 mm
G 12/25	18.1 %	1200 x 2000 mm
G 15/30	19.6 %	1200 x 1980 mm
Q 8/18	19.8 %	1188 x 1998 mm
Q 12/25	23 %	1200 x 2000 mm
G 8/12/50	13.1 %	1200 x 2000 mm
G12/20/66	19.6 %	1188 x 1980 mm

* Some perforations can also be supplied with a SK or a MF edge.
Exact panel sizes vary from module sizes according to edge type.
Contact Knauf Danoline for more information.



Edge SK



Edge MF

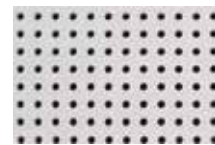

G6/18

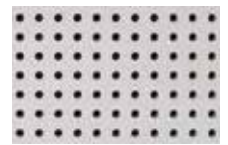

G8/18



G10/23

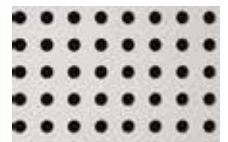

G12/25

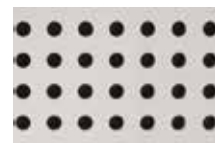

G15/30



Q8/18



Q12/25

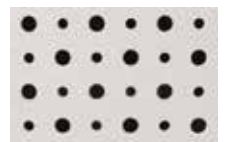

G8/12/50



G12/20/66

INSTALLATION GUIDE

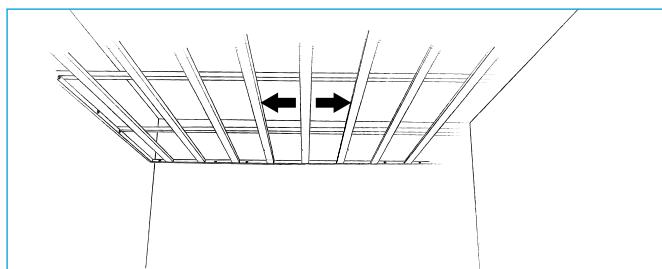
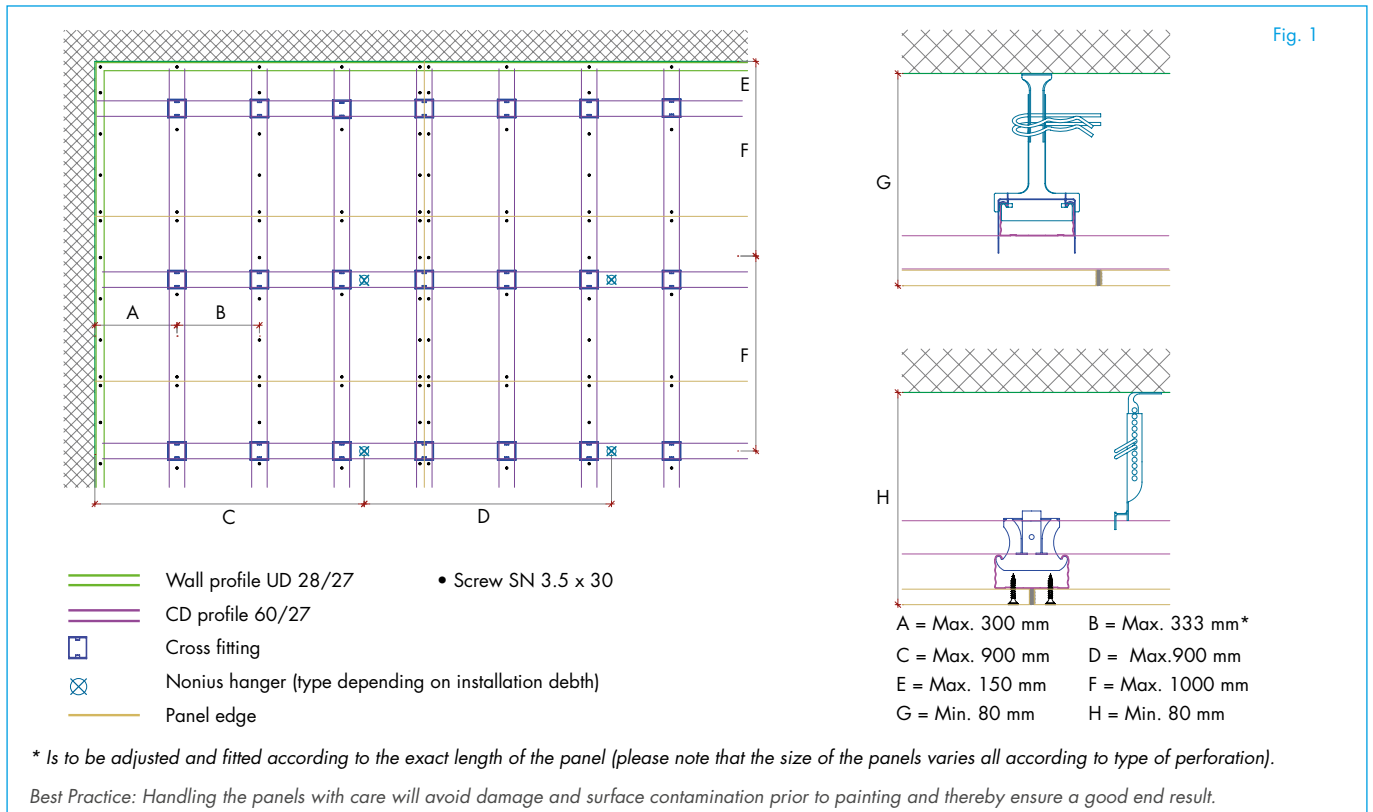

CEILING LAYOUT

- Divide the ceiling surface from the centre of the room or in accordance with the existing ceiling plans.
- Please note that expansion joints must be established on extensive ceiling surfaces at max.intervals of 15 metres in both directions. See detailed drawings on knaufdanoline.com.
- Where conditions indicate an increased risk of movement in a building, this must be taken into account by reducing the distance between expansion joints.

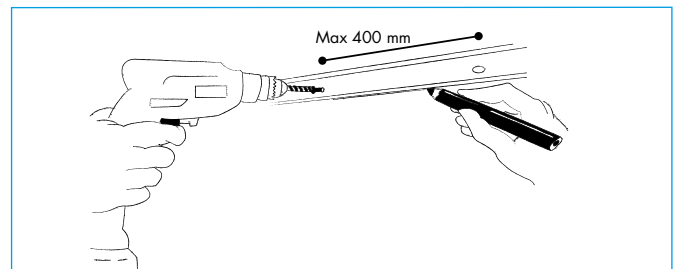

INSTALLING THE WALL PROFILE

- Mark out.
- Install the wall profile UD 28/27. Choose the method of fixing in accordance with the substrate.

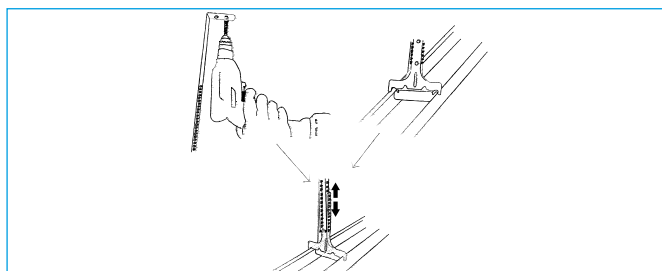

HANGERS

- Secure the upper part to the construction above it at 900 mm c/c. Choose the fixings in accordance with the substrate.
- Secure the lower part to the primary profile.

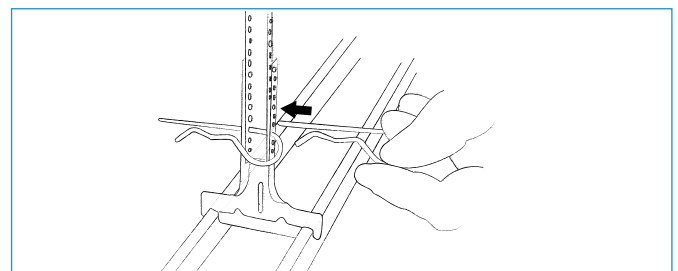

PRIMARY PROFILES

- Connect the two parts of the hangers with two split pins, one immediately above the other.

INSTALLATION GUIDE

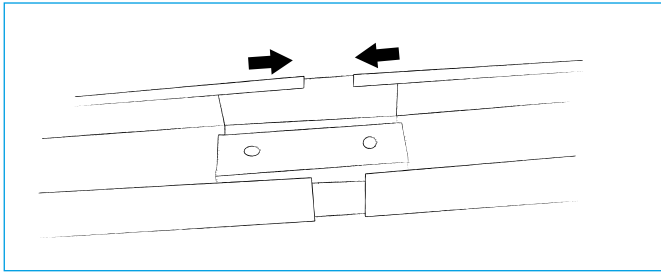

JOINING CD-PROFILES

- Join the CD profiles with the help of length connectors.

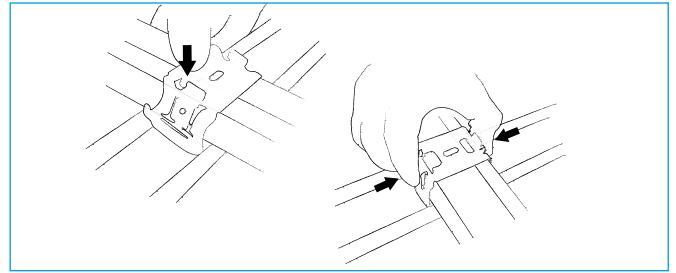

SECONDARY PROFILES

- Place a cross fitting on the primary profile.
- Press the underlying secondary profile into it.
- Adjust the locations of the secondary profiles and lock the cross fitting.
- See distances in figure 1.

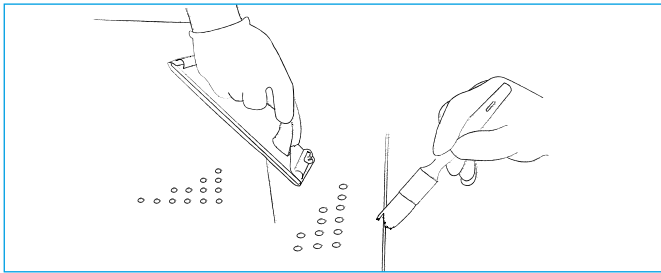
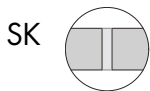

PREPARING PANELS

- Break all edges with fine sandpaper on the front so that the cardboard cannot rise during painting.
- Brush the edges free from gypsum dust and prime them with Knauf Tiefengrund (universal primer).

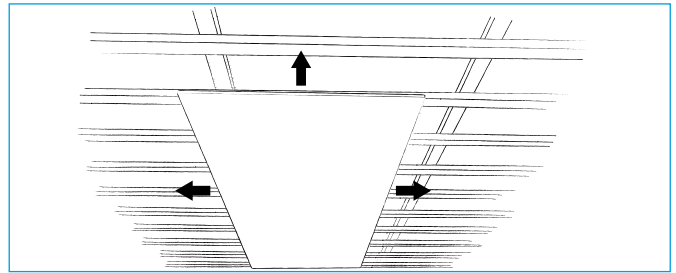
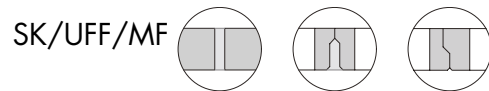

INSTALLATION SEQUENCE

- Always wear cotton gloves when handling panels.
- Begin installation in the centre of the room.
- The longitudinal direction of the panels must be 90° to the furring. Be certain that all short ends of the panels are fully supported.

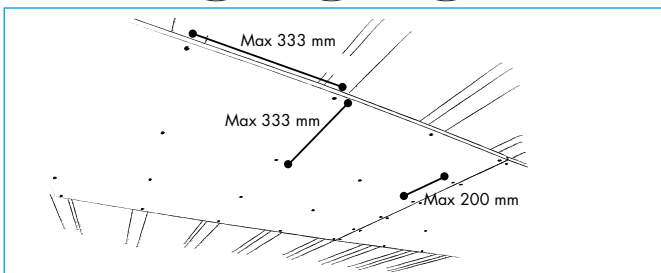
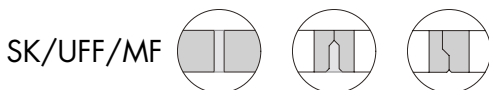

INSTALLATION

- Use a string or a laser to ensure that the perforation rows are flush. Note: The panels must all face in the same direction (**SK/UFF: red mark against blue mark**).
- Make sure that the screws are countersunk without damaging the cardboard surface.

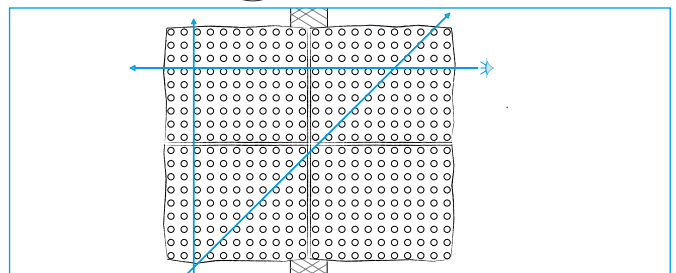

POSITIONING

- SK panels are supplied undersized, and must be installed at distances of 2-5 mm from each other to ensure that it is possible to insert filler all the way up between the edges.
- Ensure the correct distance between perforation rows at the joints. The perforation rows have to align crosswise and diagonally. See distances in previous illustration.

INSTALLATION GUIDE

SK/UFF/MF

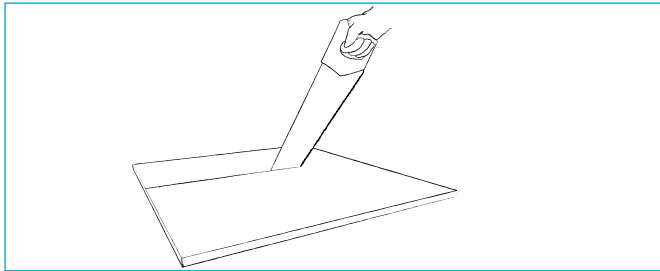
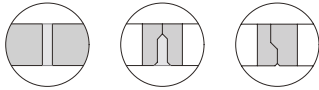

CUTTING

- Cut the elements to size from the front with a fine-toothed saw.
- Prime the edges with Knauf Tiefengrund (universal primer).

SK/UFF

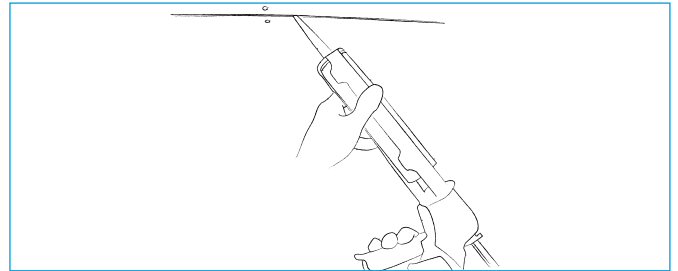
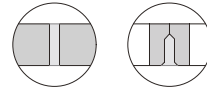

FILLING

- Check that the screws are undersunk and that the panels are not pushed close together.
- Check that the edges have been primed and are free from dust.
- Use Knauf Uniflott for filling.
- To avoid filler in the perforation holes a marking paper can be used. Use a sensitive type and test beforehand that it does not damage the surface of the panels when removed.

SK/UFF

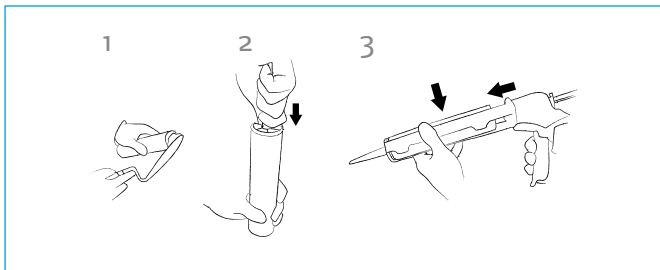
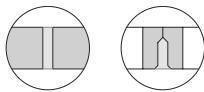

PREPARING KNAUF UNIFLOTT FILTER

- Prepare the filler according to the instructions on the filling package.
- Fill the tube with joint filler with the help of a putty knife.
- Attach the jointing nozzle.
- Insert the tube and nozzle into a jointing gun.

SK/UFF

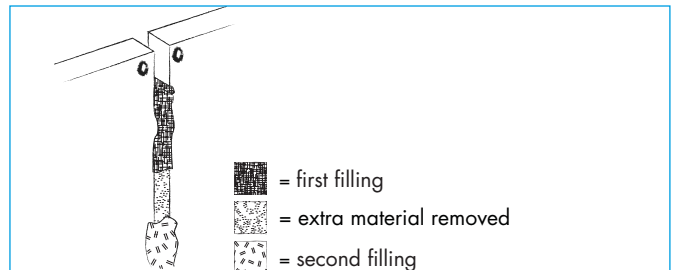
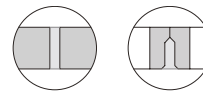

FILLING

- fill the joint with filler (Knauf Uniflott). Use a jointing gun or press the filler into the joint with a filling knife. Overfill slightly and make sure that the filler is pressed all the way up between the edges of the panels and avoid getting filler in the perforations.
- Press the filler up again by running a finger over the joint. Fill again.
- Allow the filler to dry for about 45 minutes.
- Remove surplus filler.
- Allow the filler to dry.
- Apply the second layer of filler (Knauf Uniflott Finish). Overfill slightly.
- Allow the filler to dry.

INSTALLATION GUIDE

SK/UFF/MF

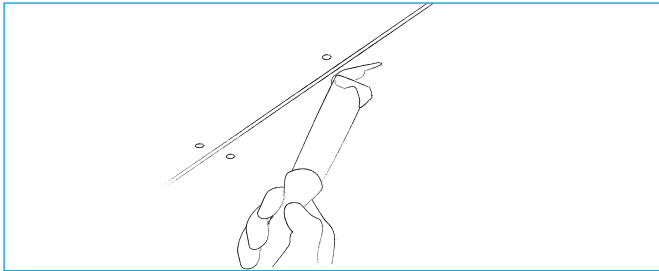
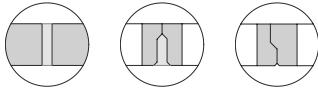

FILLING SCREW HOLES

- Apply the filler (Knauf Uniflott Finish). Overfill slightly. We recommend the use of Knauf Danogips „Acoustic filling knife for holes“ in order to avoid filler getting into the perforation holes.
- Allow the filler to dry.

SK/UFF/MF

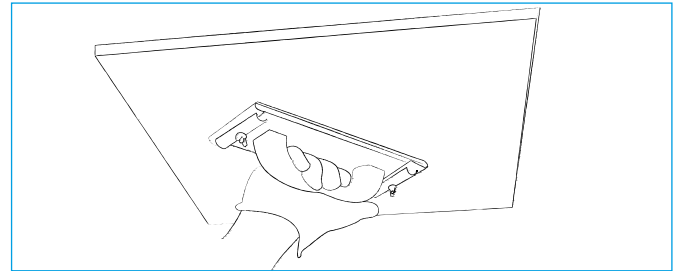

SANDING

- Make sure that the filler is completely dry.
- Sand with fine sandpaper until the surface is completely smooth. Be careful not to damage the cardboard surface.

SK/UFF/MF

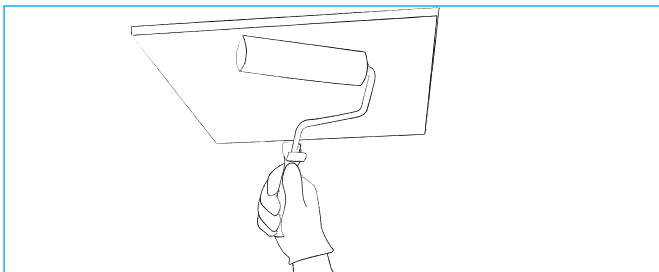
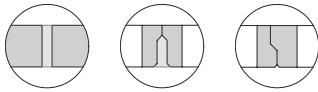

PAINTING

- Make sure that the filler is completely dry and the surface is smooth and free from dust.
- Priming should be carried out in accordance with the paint manufacturer's instructions.
- Apply the paint with a roller so that the acoustic felt on the perforated panels is not sealed. Use a fine mohair roller.
- Make sure that the paint is not too thick and avoid applying too much paint at a time.

DETAILS

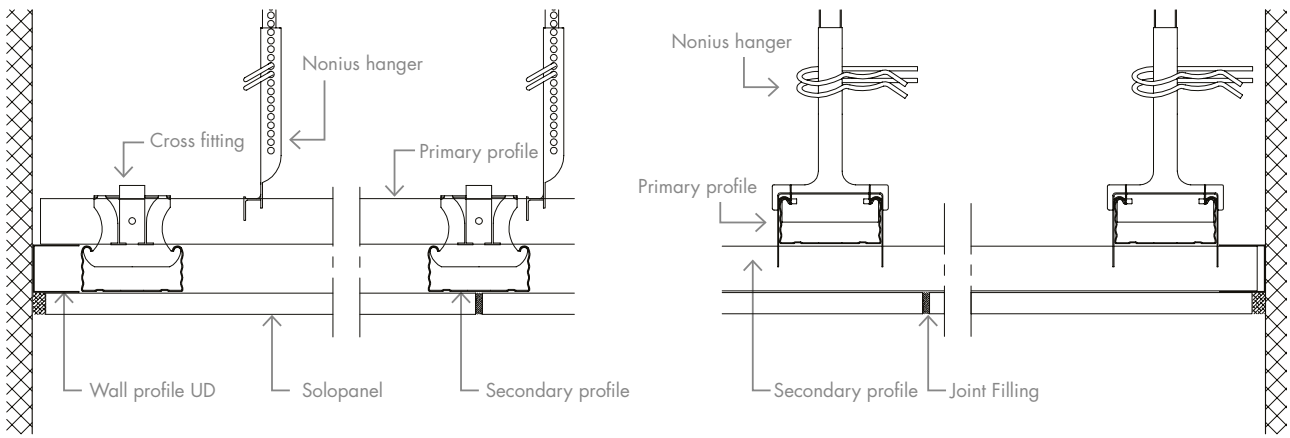

SOLOPANEL ON CD 2 SYSTEM

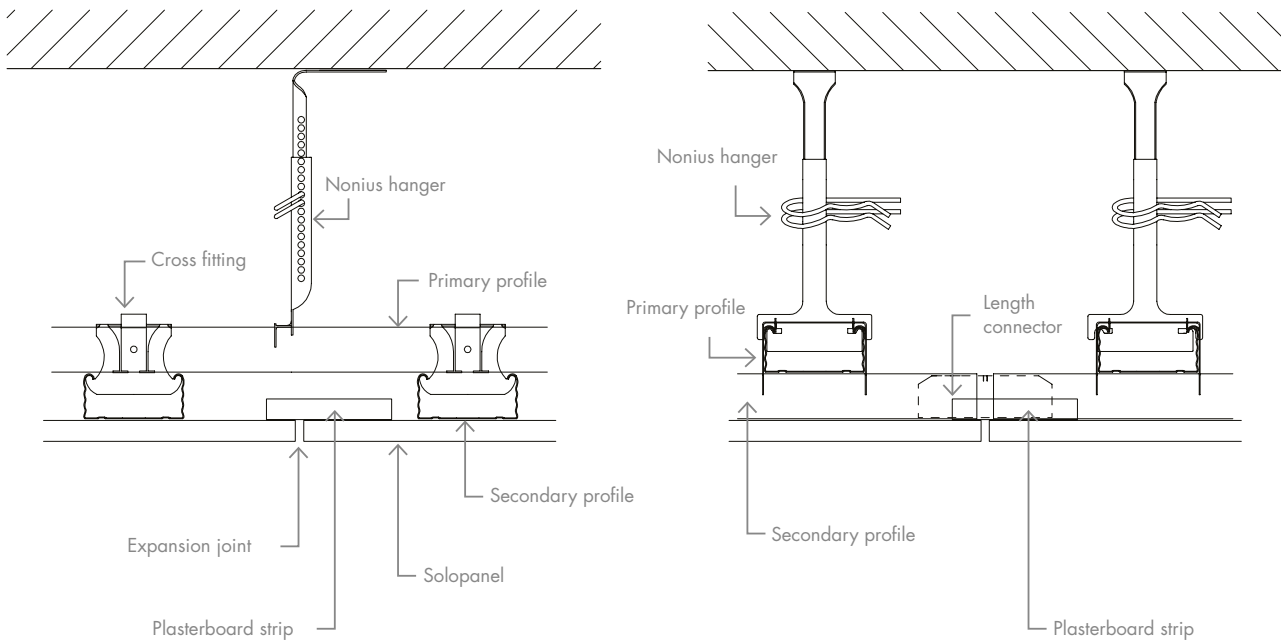

SOLOPANEL - EXPANSION JOINT



ACCESSORIES

PRODUCT NAME		SAP NO.	W x L x H (mm)	Consumption per. m ²
Primary / secondary CD 60/27-profile		3294	60 x 4000 x 27	4.6 m
Wall angle UD 28/27		181589	28 x 3000 x 27	1.0*
Length connector CD 60/27		181080	59 x 80 x 28	1.1 pcs.
Cross-fitting		3446	-	3.3 pcs.
Split pin for hanger		198907	-	2.6 pcs.
Nonius hanger lower		198904	-	1.3 pcs.
Nonius hanger, upper 85 mm		198905	125 - 185	1.3 pcs.
Nonius hanger, upper 135 mm		198906	135 - 235	
Nonius hanger, upper 235 mm		198923	235 - 340	
Nonius hanger, upper 340 mm		198924	340 - 440	
Nonius hanger, upper 440 mm		198925	440 - 540	
Nonius hanger, upper 540 mm		198926	540 - 640	
Nonius hanger, upper 640 mm		198927	640 - 740	
Nonius hanger, upper 740 mm		198928	740 - 840	
Nonius hanger, upper 840 mm		198929	840 - 940	
Nonius hanger, upper 940 mm		198930	940 - 1040	
Knauf Tiefengrund (Universal Primer)		253759	5 L	0.02 L
Uniflott Finish		129801	8 kg	0.1 kg
Knauf Uniflott		253631	25 kg	0.4 kg
		253630	5 kg	
Filler tube set		4707	-	-
Filling knife		73962	-	-
Screws SN 3.5x30		3503	3.5 x 30	20 pcs.

*Depending on room size.

DID YOU KNOW THAT ...

gypsum boards used for Knauf Danoline products are made of 90% industry recycled gypsum, 9% recycled gypsum and 1% recycled paper?

STRATOPANEL

ACOUSTICAL CEILING PANELS

Continuous random perforation pattern offering a fluid, monolithic look. Acoustic gypsum lining for ceiling surfaces.

ACOUSTICAL CEILING PANELS

STRATOPANEL

SURFACE

Untreated

DANISH INDOOR CLIMATE LABELLING (DIM)

Indoor value: 10 days

Particle emission: low (< 0.75 mg)

CLEANING

Dust is removed using a dry duster or vacuum cleaner. Removal of marks depends on the paint used on site, although a damp cloth using normal cleaning practices and neutral cleaning solutions is normally suitable for minor marks. In the case of stubborn marks or if in doubt refer to the paint manufacturer's recommendations.

LIGHT REFLECTION

Depends on the paint used on site.

AMBIENT CONDITIONS

The product is designed to perform under normal conditions of use. Tested at 90% RH and 30°C. The product can withstand ambient temperatures of up to 50°C.

LOAD-BEARING CAPACITY

2 / A / No load

2 / B / 30N

FIRE CLASS

A2-s1,d0

ROBUSTNESS

Made of robust, glass fibre reinforced material with excellent pressure resistance and can therefore be used on walls as well as ceilings. Under normal conditions of use, the product properties are preserved and there is no decomposition of material over time.

WEIGHT

Indicative tile weight: 8.00 – 9.30 kg/m².

All according to type of perforation and thickness.



CERTIFICATES

- Declaration of Conformity (EN 14190)
- Danish Indoor Climate Labelling

ACOUSTICAL CEILING PANELS STRATOPANEL

ACOUSTICS

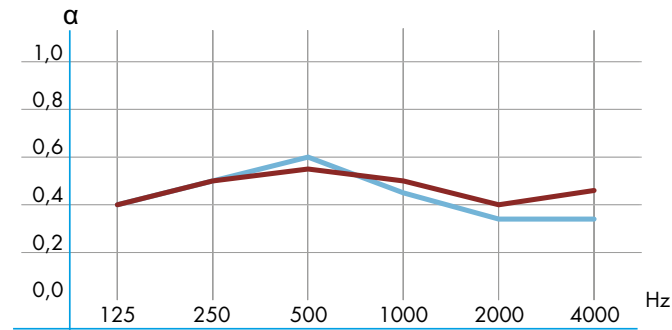

	125	250	500	1000	2000	4000
● α	0,40	0,50	0,55	0,50	0,40	0,45
● α	0,40	0,50	0,60	0,45	0,35	0,35

- G8/15/20, 200 mm suspension, no mineral wool α_w : 0.50, NRC: 0.50
- G12/20/35, 200 mm suspension, no mineral wool α_w : 0.45, NRC: 0.50

For acoustic data on alternative constructions please see "Absorption Data" at knaufdanoline.com

EDGES



Edge SK
No visible joints



Edge UFF
No visible joints





PERFORATION

PERFORATION TYPE	PERFORATION PERCENTAGE	EDGE UFF SIZES
G8/15/20	9.9 %	1200 x 2000 or 1200 x 2500 mm
G12/20/35	9.8 %	1200 x 1875 or 1200 x 2500 mm

* Some perforations can also be supplied with a SK edge.
Exact panel sizes vary from module sizes according to edge type.
Contact Knauf Danoline for more information.



Edge SK



G8/15/20

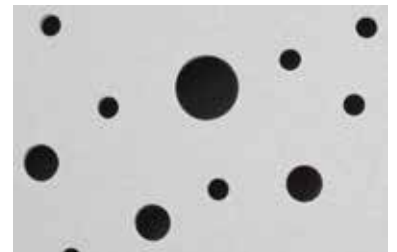

G12/20/35

INSTALLATION GUIDE

Legend:

- Wall profile UD 28/27 • Screw SN 3,5 x 30
- CD profile 60/27
- Cross fitting
- Nonius hanger (type depending on installation depth)
- Panel edge

Dimensions:

- A = Max. 300 mm B = Max. 333 mm*
- C = Max. 900 mm D = Max. 900 mm
- E = Max. 150 mm F = Max. 1000 mm
- G = Min. 80 mm H = Min. 80 mm

* Is to be adjusted and fitted according to the exact length of the panel (please note that the size of the panels varies all according to type of perforation).

Best Practice: Handling the panels with care will avoid damage and surface contamination prior to painting and thereby ensure a good end result.

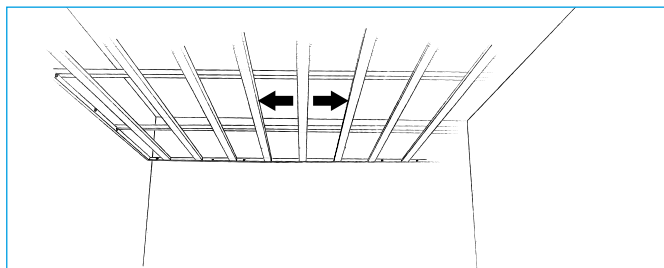

CEILING LAYOUT

- Divide the ceiling surface from the centre of the room or in accordance with the existing ceiling plans.
- Please note that expansion joints must be established on extensive ceiling surfaces at max. intervals of 15 metres in both directions. See detailed drawings on knaufdanoline.com.
- Where conditions indicate an increased risk of movement in a building, this must be taken into account by reducing the distance between expansion joints.

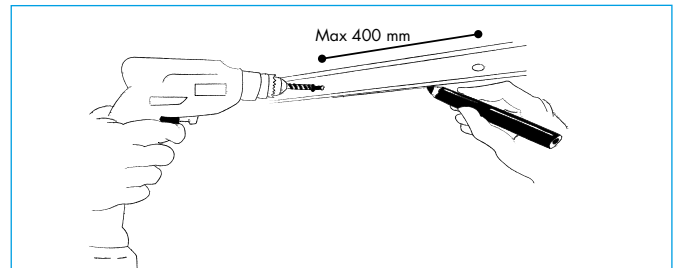

INSTALLING THE WALL PROFILE

- Mark out.
- Install the wall profile UD 28/27. Choose the method of fixing in accordance with the substrate.

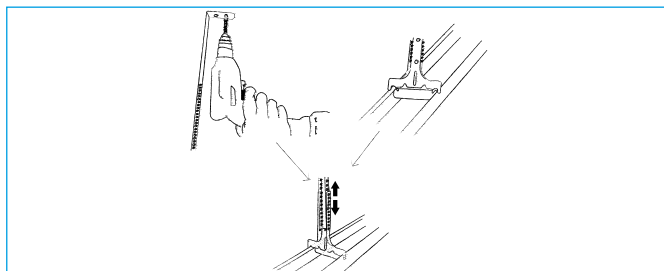

HANGERS

- Secure the upper part to the construction above it at 900 mm c/c. Choose the fixings in accordance with the substrate.
- Secure the lower part to the primary profile.

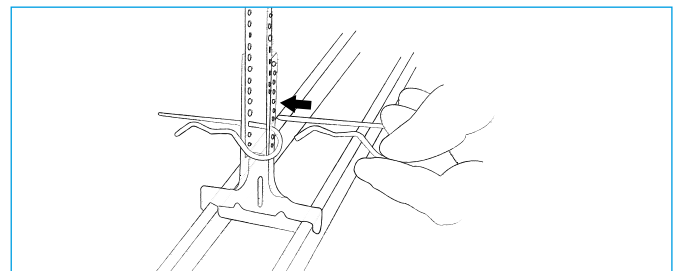

PRIMARY PROFILES

- Connect the two parts of the hangers with two split pins, one immediately above the other.

INSTALLATION GUIDE

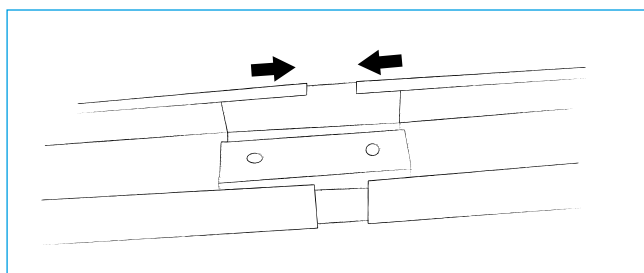

JOINING CD-PROFILES

- Join the CD profiles with the help of length connectors.

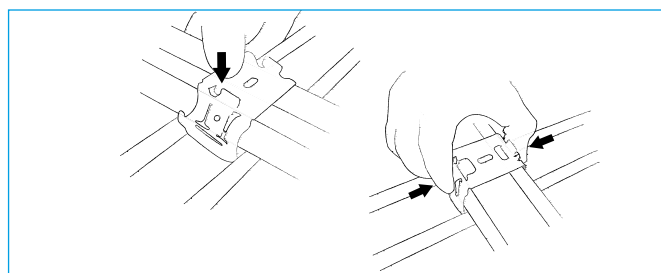

SECONDARY PROFILES

- Place a cross fitting on the primary profile.
- Press the underlying secondary profile into it.
- Adjust the locations of the secondary profiles and lock the cross fitting.
- See distances in figure 1.

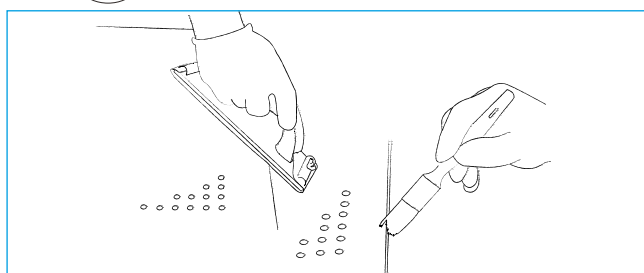
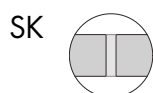

PREPARING PANELS

- Break all edges with fine sandpaper on the front so that the cardboard cannot rise during painting.
- Brush the edges free from gypsum dust and prime them with Knauf Tiefengrund (universal primer).

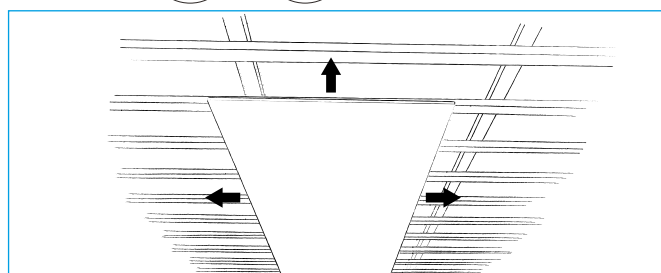
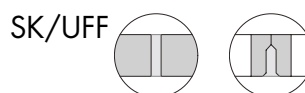

INSTALLATION SEQUENCE

- Begin installation in the centre of the room.
- The longitudinal direction of the panels must be 90° to the furring. Be certain that all short ends of the panels are fully supported.

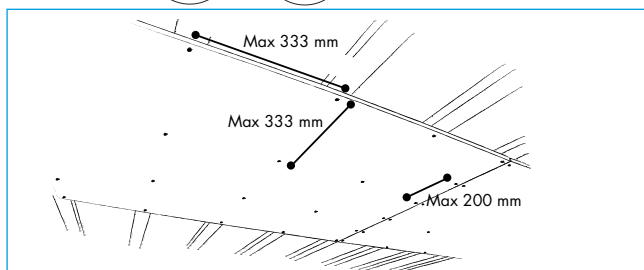
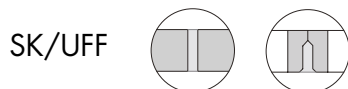

INSTALLATION

- Use a string or a laser to ensure that the perforation rows are flush. Note: The panels must all face in the same direction (**Red mark against blue mark**).
- SK panels are supplied undersized, and must be installed at distances of 2-5 mm from each other to ensure that it is possible to insert filler all the way up between the edges.
- Make sure that the screws are countersunk without damaging the cardboard surface.

INSTALLATION GUIDE

SK/UFF

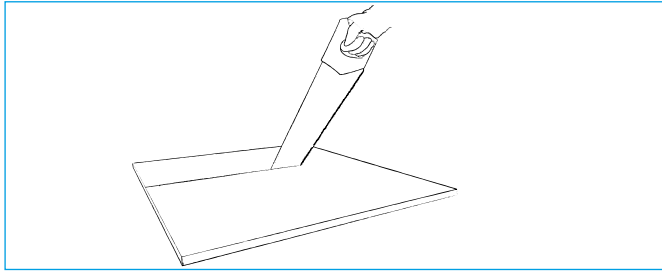
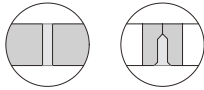

CUTTING

- Cut the elements to size from the front with a fine-toothed saw.
- Prime the edges with Knauf Tiefengrund (universal primer).

SK/UFF

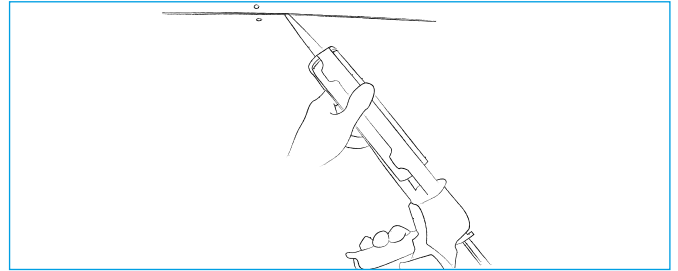
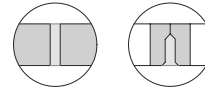

FILLING

- Check that the screws are countersunk and that the panels are not pushed close together.
- Check that the edges have been primed and are free from dust.
- Use Knauf Uniflott for filling.
- To avoid filler in the perforation holes a marking paper (sensitive tape) can be used. Use a sensitive type and test beforehand that it does not damage the surface of the panels when removed.

SK/UFF

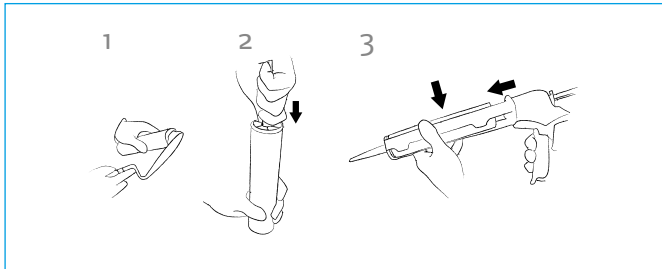
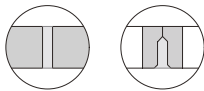

PREPARING KNAUF UNIFLOTT FILLER

- Prepare the filler according to the instructions on the filling package.
- Fill the tube with joint filler with the help of a putty knife.
- Attach the jointing nozzle.
- Insert the tube and nozzle into a jointing gun.

SK/UFF

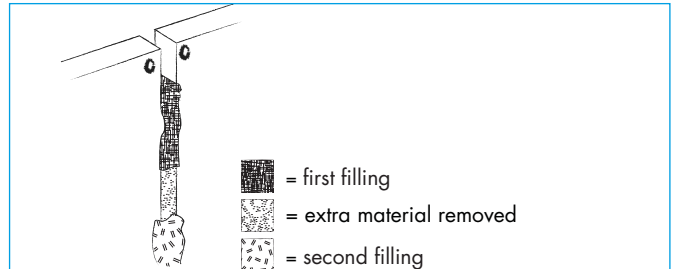
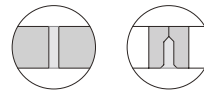

FILLING

- Fill the joint with filler (Knauf Uniflott). Use a jointing gun or press the filler into the joint with a filling knife. Overfill slightly and make sure that the filler is pressed all the way up between the edges of the panels and avoid getting filler in the perforations.
- Press the filler up again by running a finger over the joint. Fill again.
- Allow the filler to dry for about 45 minutes.
- Remove surplus filler.
- Allow the filler to dry.
- Apply the second layer of filler (Knauf Uniflott Finish). Overfill slightly.
- Allow the filler to dry.

INSTALLATION GUIDE

SK/UFF

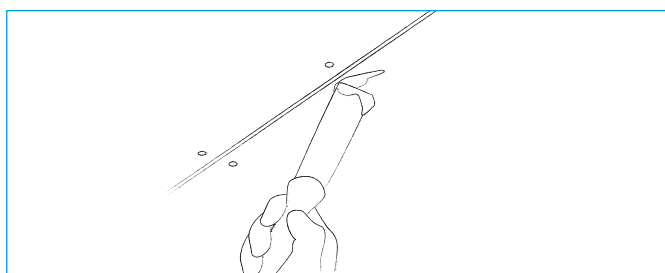
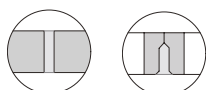

FILLING SCREW HOLES

- Apply the filler (Knauf Uniflott Finish). Overfill slightly. We recommend the use of Knauf Danogips „Acoustic filling knife for holes“ in order to avoid filler getting into the perforation holes.
- Allow the filler to dry.

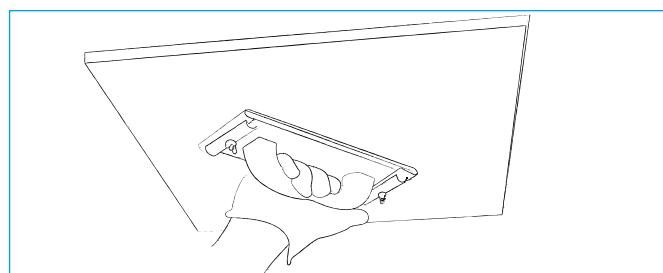

SANDING

- Make sure that the filler is completely dry.
- Sand with fine sandpaper until the surface is completely smooth. Be careful not to damage the cardboard surface.

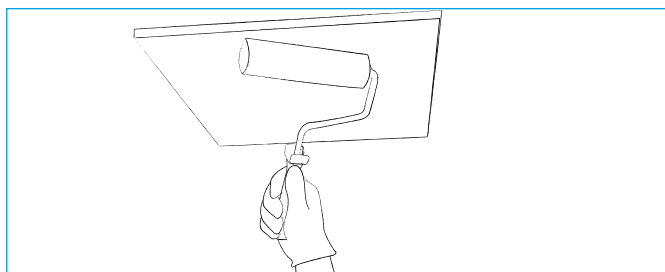

PAINTING

- Make sure that the filler is completely dry and the surface is smooth and free from dust.
- Priming should be carried out in accordance with the paint manufacturer's instructions.
- Apply the paint with a roller so that the acoustic felt on the perforated panels is not sealed. Use a fine mohair roller.
- Make sure that the paint is not too thick and avoid applying too much paint at a time.

DETAILS



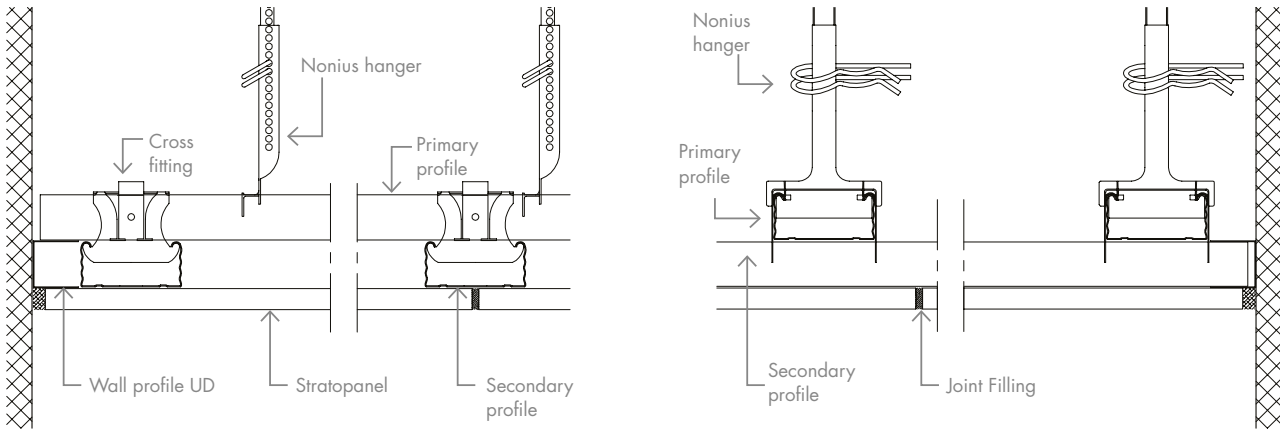



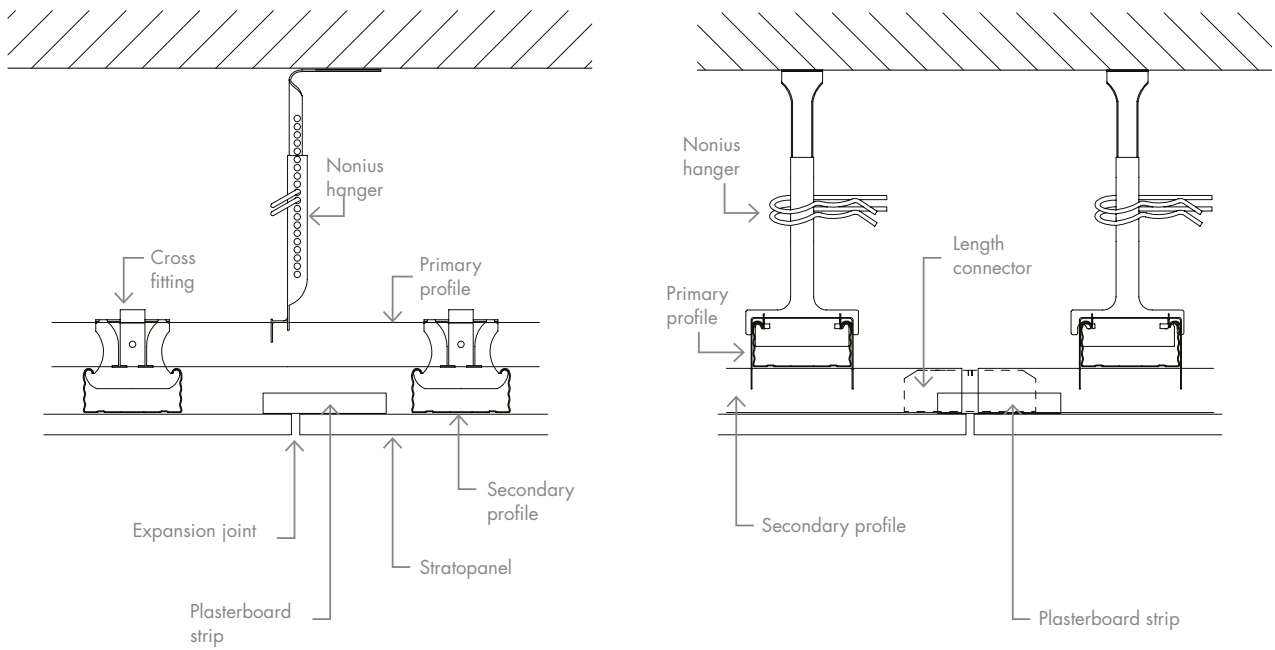



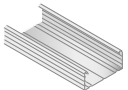

STRATOPANEL ON CD 2 SYSTEM



STRATOPANEL - EXPANSION JOINT



ACCESSORIES

PRODUCT NAME		SAP NO.	W x L x H (mm)	Consumption per. m ²
Primary / secondary CD 60/27-profile		3294	60 x 4000 x 27	4.6 m
Wall angle UD 28/27		181589	28 x 3000 x 27	1.0*
Length connector CD 60/27		181080	59 x 80 x 28	1.1 pcs.
Cross-fitting		3446	-	3.3 pcs.
Split pin for hanger		198907	-	2.6 pcs.
Nonius hanger lower		198904	-	1.3 pcs.
Nonius hanger, upper 85 mm		198905	125 - 185	1.3 pcs.
Nonius hanger, upper 135 mm		198906	135 - 235	
Nonius hanger, upper 235 mm		198923	235 - 340	
Nonius hanger, upper 340 mm		198924	340 - 440	
Nonius hanger, upper 440 mm		198925	440 - 540	
Nonius hanger, upper 540 mm		198926	540 - 640	
Nonius hanger, upper 640 mm		198927	640 - 740	
Nonius hanger, upper 740 mm		198928	740 - 840	
Nonius hanger, upper 840 mm		198929	840 - 940	
Nonius hanger, upper 940 mm		198930	940 - 1040	
Knauf Tiefengrund (Universal Primer)		253759	5 L	0.02 L
Uniflott Finish		129801	8 kg	0.1 kg
Knauf Uniflott		253631	25 kg	0.4 kg
		253630	5 kg	
Filler tube set		4707	-	-
Filling knife		73962	-	-
Screws SN 3.5x30		3503	3.5 x 30	20 pcs.

*Depending on room size.

DESIGNPANEL

ACOUSTIC WALL PANELS

Wall lining with a unified expression without visible joints.
Suitable for flat surfaces and for curving on site or from
the factory.

DID YOU KNOW THAT ...

0.13% of seawater content
is gypsum and that there are
large quantities of desiccated
natural gypsum around the
Mediterranean?

ACOUSTIC WALL PANELS

DESIGNPANEL

SIZES

Dimension: Available with:
 900 x 2700 x 12.5 mm* Globe, Quadril, Micro
 1200 x 2400 x 12.5 mm Globe, Quadril, Micro
 900 x 2400 x 12.5 mm Tangent

SURFACE

Untreated

DANISH INDOOR CLIMATE LABELLING (DIM)

Indoor value: 10 days
 Particle emission: low (< 0.75 mg)

CLEANING

Dust is removed using a dry duster or vacuum cleaner. Removal of marks depends on the paint used on site, although a damp cloth using normal cleaning practices and neutral cleaning solutions is normally suitable for minor marks. In the case of stubborn marks or if in doubt refer to the paint manufacturer's recommendations.

AMBIENT CONDITIONS

The product is designed to perform under normal conditions of use. Tested at 90% RH and 30°C. The product can withstand ambient temperatures of up to 50°C.

LIGHT REFLECTION

Depends on the paint used on site.

FIRE CLASS

A2-s1,d0

FIRE RATING

Class 1; K₁ 10, A2-s1,d0; BD 30

ROBUSTNESS

Made of robust, glass fibre reinforced material with excellent pressure resistance. Under normal conditions of use, the product properties are preserved and there is no decomposition of material over time.

WEIGHT

Indicative tile weight: 9.20 kg/m².
 All according to type of perforation.



CERTIFICATES

- Declaration of Conformity (EN 14190)
- Danish Indoor Climate Labelling

ACOUSTIC WALL PANELS DESIGNPANEL

ACOUSTICS

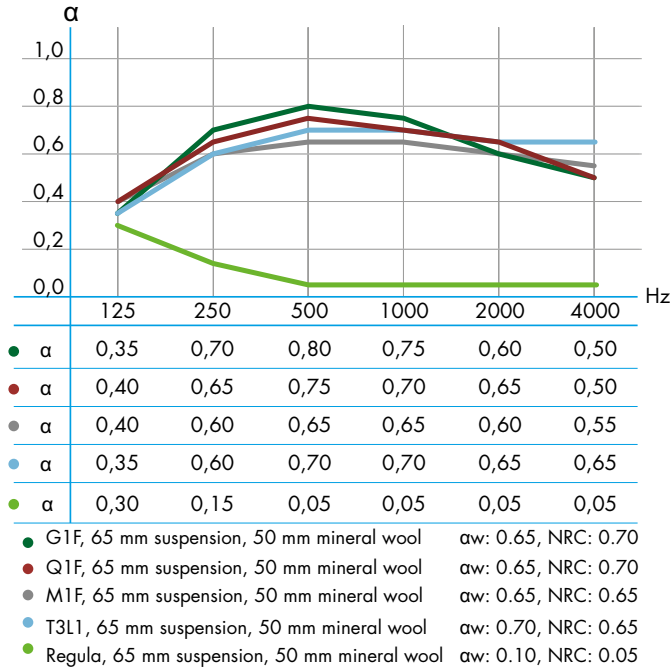

For acoustic data on alternative constructions please see "Absorption Data" at knaufdanoline.com

EDGES



Edge B1

Edge B1 (EN 520). 4 tapered edges
No visible joints

For Globe, Quadril, Micro and Tangent



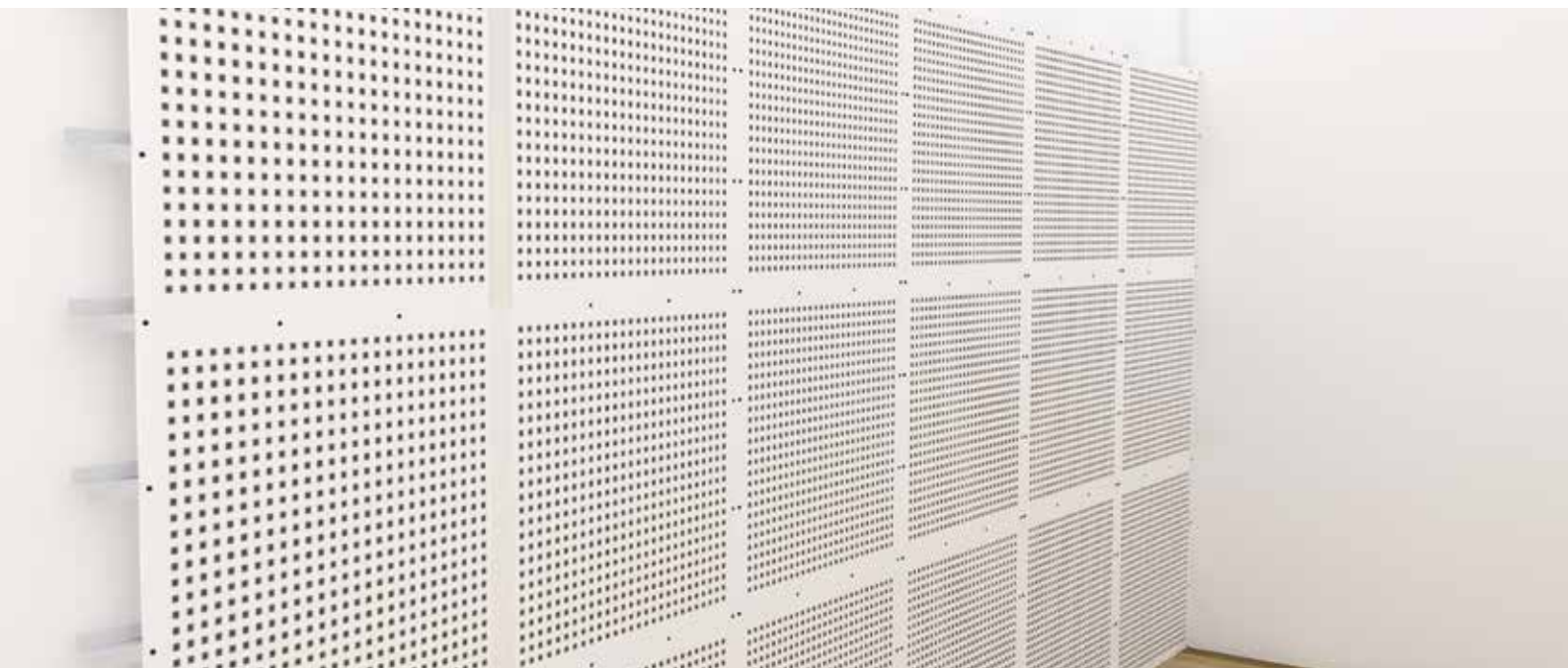

PERFORATION

Also available as Regula.

Other perforation patterns are manufactured to order.



Globe, Ø6 mm,
15 mm c/c
Perforation: 5.3 - 9.8%

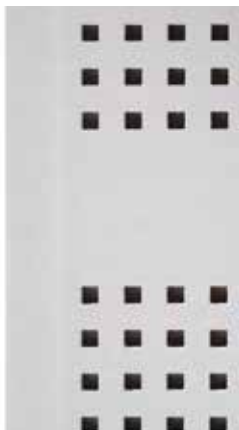

Quadril, 12 x 12 mm,
30 mm c/c
Perforation: 7.8 - 13%



Micro, 3 x 3 mm,
8.3 mm c/c
Perforation: 7.1 - 9.8%



Tangent, 4 x 14 mm,
10/20 mm
Perforation: 13.3 - 15.0.
15.8%

INSTALLATION GUIDE

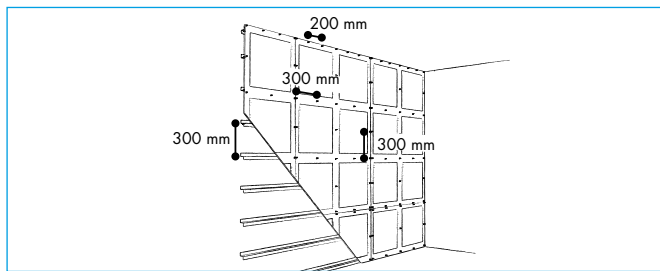
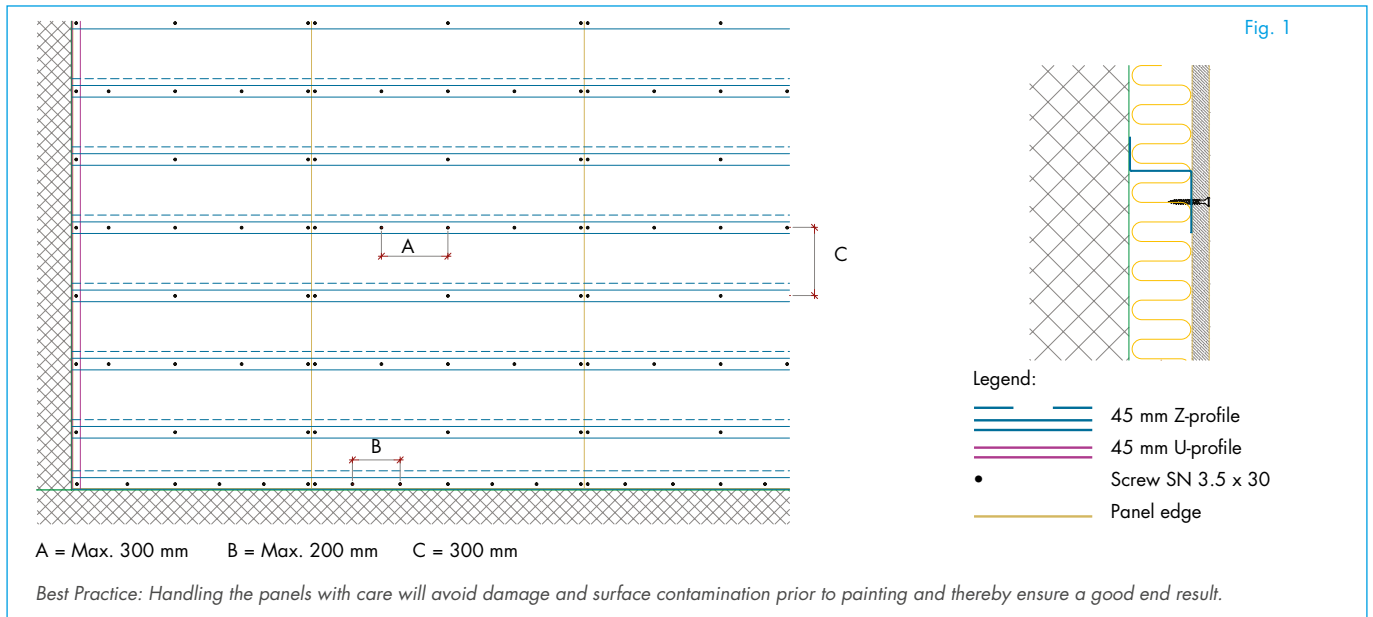

FURRING

- Depending on current fire regulations Designpanel can be installed on wood or steel furrings.
- Furrings can be vertical or horizontal but should in general be at right angles to the direction of the panels to ensure that the end edges of the panels are properly supported.
- Furrings should be at least 45 mm in width.
- Also see the section "Acoustics" on next page.

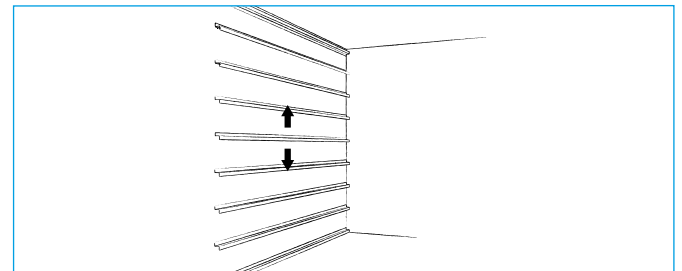

LAYOUT

- Perforated wall panels are normally installed on the upper section of a wall in accordance with acoustic requirements and the shape of the room in question.
- However, perforated panels can also be used to cover an entire wall, depending on the degree of physical impact.
- Follow any available drawings or divide the surface of the wall so that the perforated modules are positioned symmetrically in the room.
- Expansion joints should be established on extensive wall surfaces at intervals of max. 15 metres. See detailed drawings on knaufdanoline.com.

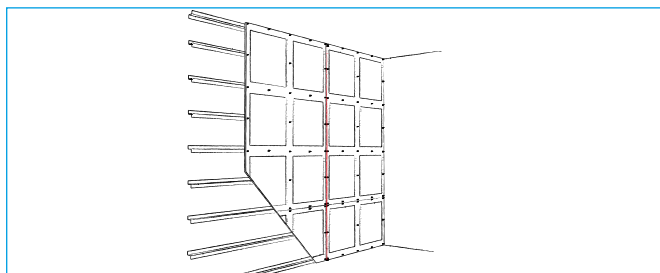

INSTALLATION

- Install the first row of panels with the help of string.
- See distances in figure 1. Screws must be fixed 10 mm from the long panel edge and 15 mm from the end panel edge.
- The panels are supplied undersized and must be installed at distances of up to 4 mm from each other to ensure that it is possible to insert filler all the way up between the edges of the panels.
- The perforated fields must be flush in their own rows and at right angles to the adjacent fields.
- Cut the elements to size from the front with a fine-toothed saw.

INSTALLATION GUIDE

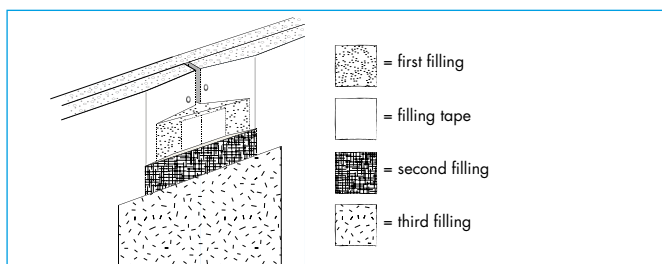

FILLING

- Apply the first layer of filler (Easy Filler Light). Make sure it is pressed all the way up between the panel edges and avoid getting filler in the perforations.
- Apply filler tape to the wet filler.
- The first filling and application of filler tape can be carried out in a single, very simple operation by using a Mini Bazooka.
- Allow the filler to dry. Make sure that the filler is completely dry before sanding. Sand with fine sandpaper. Be careful not to damage the cardboard surface.
- Apply the second layer of filler (Easy Filler Light).
- Allow the filler to dry. Make sure that the filler is completely dry before sanding. Sand with fine sandpaper. Be careful not to damage the cardboard surface.
- Apply the third layer of filler (Easy Filler Light). Make sure that the filler is completely dry before sanding. Sand with fine sandpaper until the joint is completely smooth. Be careful not to damage the cardboard surface.

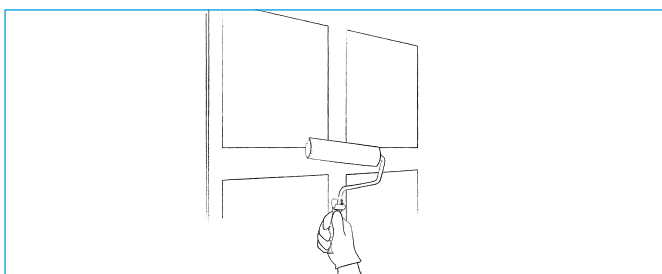

PAINTING

- Make sure that the filler is completely dry and the surface is free from dust.
- Priming should be carried out in accordance with the paint manufacturer's instructions.
- Apply the paint with a roller so that the acoustic felt on the perforated panels is not sealed. Use a fine mohair roller.
- Make sure that the paint is not too thick and avoid applying too much paint at a time.
- Spraying cannot be recommended as this could influence the acoustic properties of the panels.

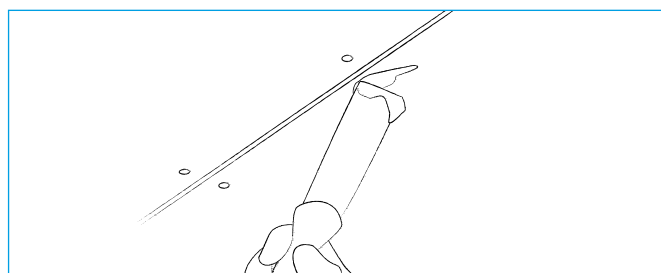

FILLING SCREW HOLES

- Check that the screws have been countersunk.
- Apply the first layer of filler (Easy Filler Light).
- Allow the filler to dry.
- Sand with fine sandpaper.
- Apply the second layer of filler (Knauf Uniflott Finish), overfill slightly.
- Allow the filler to dry.
- Sand with fine sandpaper until the surface is completely smooth. Be careful not to damage the cardboard surface.

ACOUSTICS

- A perforated gypsum panel will lose its acoustic function if the perforations are blocked (this applies to the front and back of the panel).
- Where applicable, a vapour barrier should therefore always be placed behind the furrings so that it does not come into contact with the back of the perforated panel.
- When installing Designpanel on a fixed surface we recommend filling the cavity between the back of the panel and the furring with mineral wool. This is primarily to ensure low frequency sound absorption.

DETAILS

DESIGNPANEL - INTEGRATED ACOUSTIC WALL

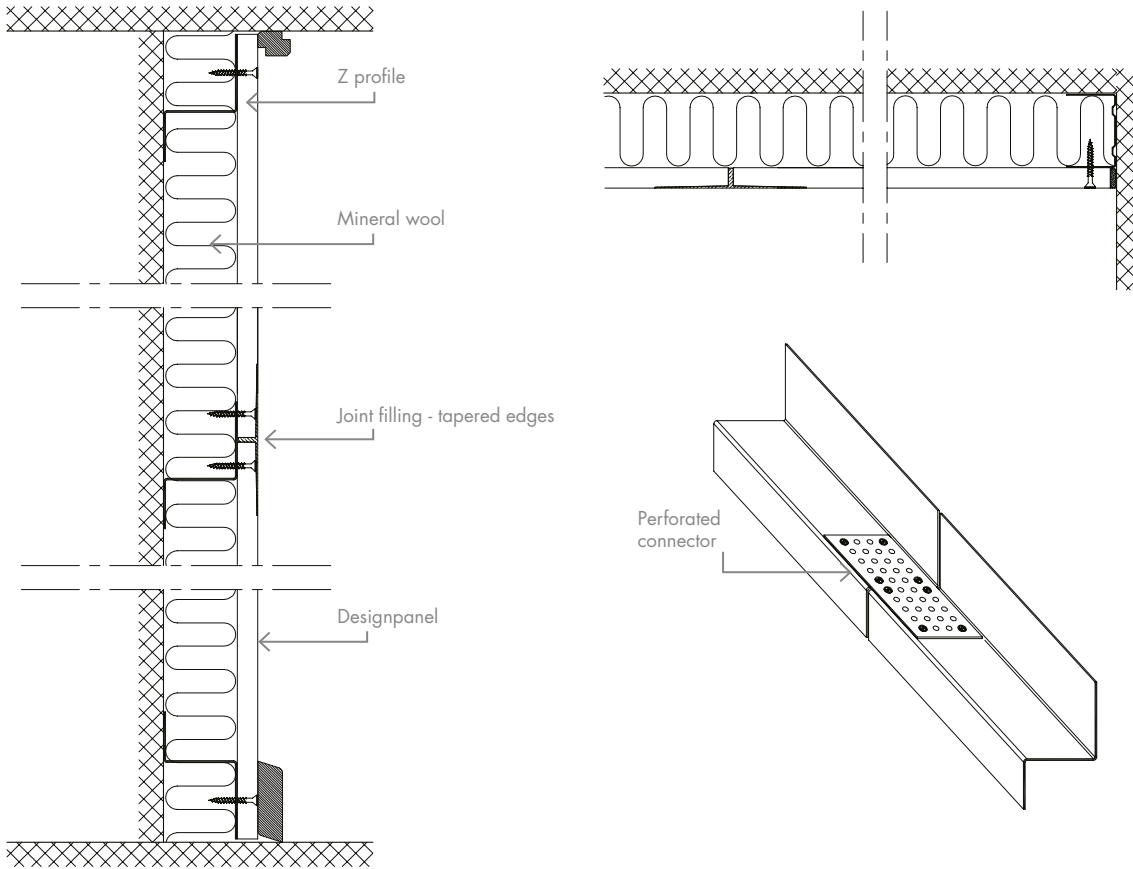

DESIGNPANEL - ADD-ON ACOUSTIC WALL PANELS

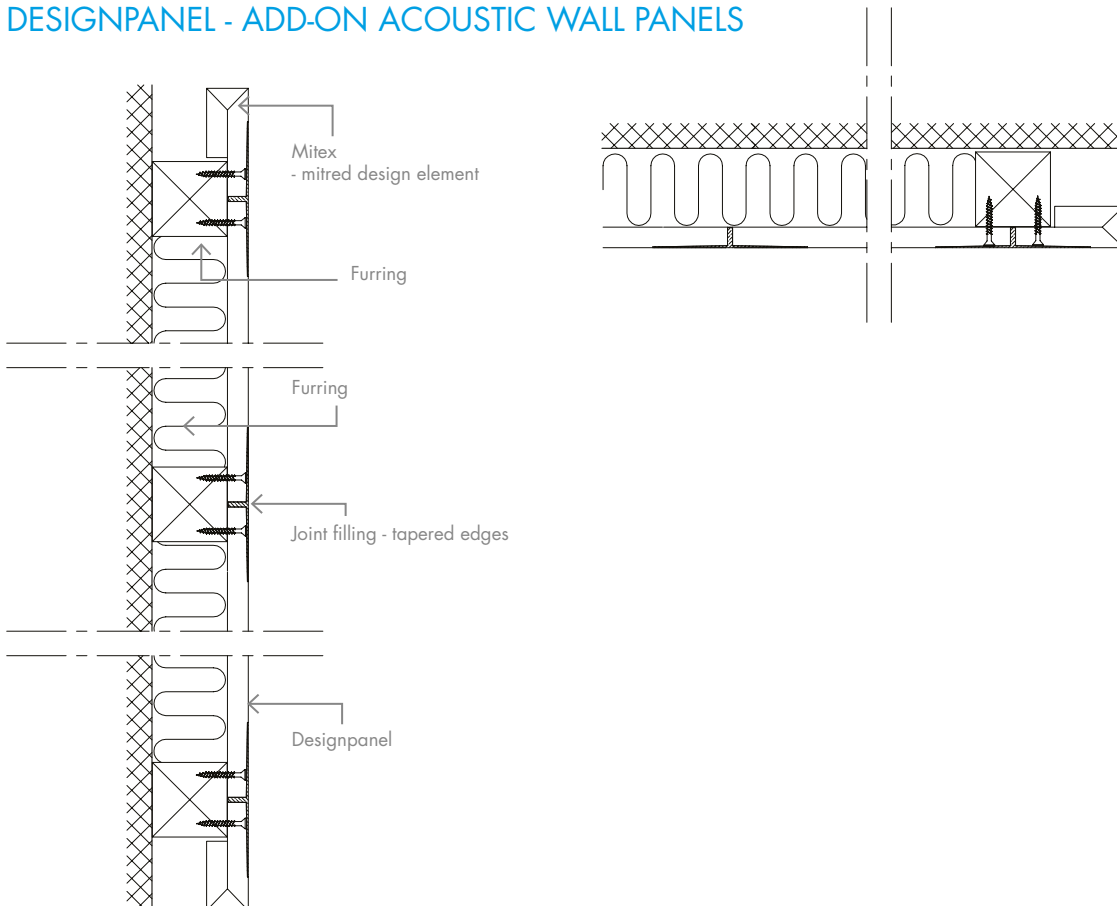

ACCESSORIES

PRODUCT NAME		SAP. NO.	W x L x H (mm)
Z-profile		199089	30 x 45 x 45 x 2300
Screws SN 3.5		3503	3.5 x 30 mm
Easy Filler		181230	10 L
		235309	15 L
Uniflott Finish		129801	8 kg
Filler tape		314828	75 m
Filling knife		73962	-

CURVED PANELS

Apply water on the front face and leave for 30 minutes. If necessary the panel can be covered in plastic to assist the panel in absorbing the water.

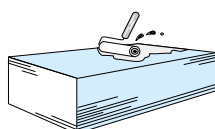

Lay the panel over a template. Secure the panel on one side of the template.

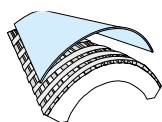

To minimize the risk of mold formation during the process, make then sure that a fast drying of the boards is present. A good ventilation with high air exchange and relative high temperature is needed and with advantage the boards can be bended and dried out before mounting.

Press the panel against the template using a batten, moving it every 100 mm.

Secure the panel on the other side of the template. Make sure that the panel is fully dry before mounting or closing the construction.

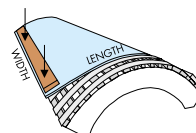

TECTOPANEL

ACOUSTIC WALL PANELS

Acoustic wall lining offering flexibility. Blank canvas providing numerous opportunities for creative design. Available in a large number of sizes. Suitable for curving on site or from factory.

DID YOU KNOW THAT ...

Knauf Danoline acoustical ceilings and walls can meet your national requirements in terms of acoustics?

ACOUSTIC WALL PANELS

TECTOPANEL

SIZES

400 x 600 x 9,5 mm	R
600 x 600 x 12,5 mm	G, M, T, R
600 x 2400 x 12,5 mm	R
625 x 625 x 12,5 mm	G, M, R
625 x 1250 x 12,5 mm	G, R

Other sizes on request

SURFACE

Untreated

DANISH INDOOR CLIMATE LABELLING (DIM)

Indoor value: 10 days

Particle emission: low (< 0.75 mg)

CLEANING

Dust is removed using a dry duster or vacuum cleaner. Removal of marks depends on the paint used on site, although a damp cloth using normal cleaning practices and neutral cleaning solutions is normally suitable for minor marks. In the case of stubborn marks or if in doubt refer to the paint manufacturer's recommendations.

AMBIENT CONDITIONS

The product is designed to perform under normal conditions of use. Tested at 90% RH and 30°C. The product can withstand ambient temperatures of up to 50°C.

LIGHT REFLECTION

Depends on the paint used on site.

FIRE CLASS

A2-s1,d0

FIRE RATING

Class 1; K₁ 10, A2-s1,d0; BD 30

ROBUSTNESS

Made of robust, glass fibre reinforced material with excellent pressure resistance. Under normal conditions of use, the product properties are preserved and there is no decomposition of material over time.

WEIGHT

Indicative tile weight: 7.70 – 9.90 kg/m².

All according to type of perforation and thickness.



CERTIFICATES

- Declaration of Conformity (EN 14190)
- Danish Indoor Climate Labelling

ACOUSTIC WALL PANELS

TECTOPANEL

ACOUSTICS

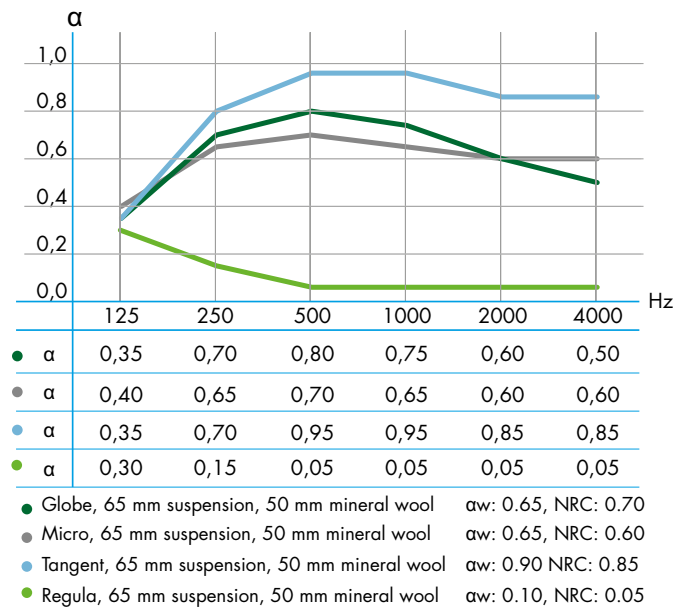

For acoustic data on alternative constructions please see "Absorption Data" at knaufdanoline.com

EDGES



Edge B

(bevelled edge)

Visible joints

For Globe, Micro and Tangent



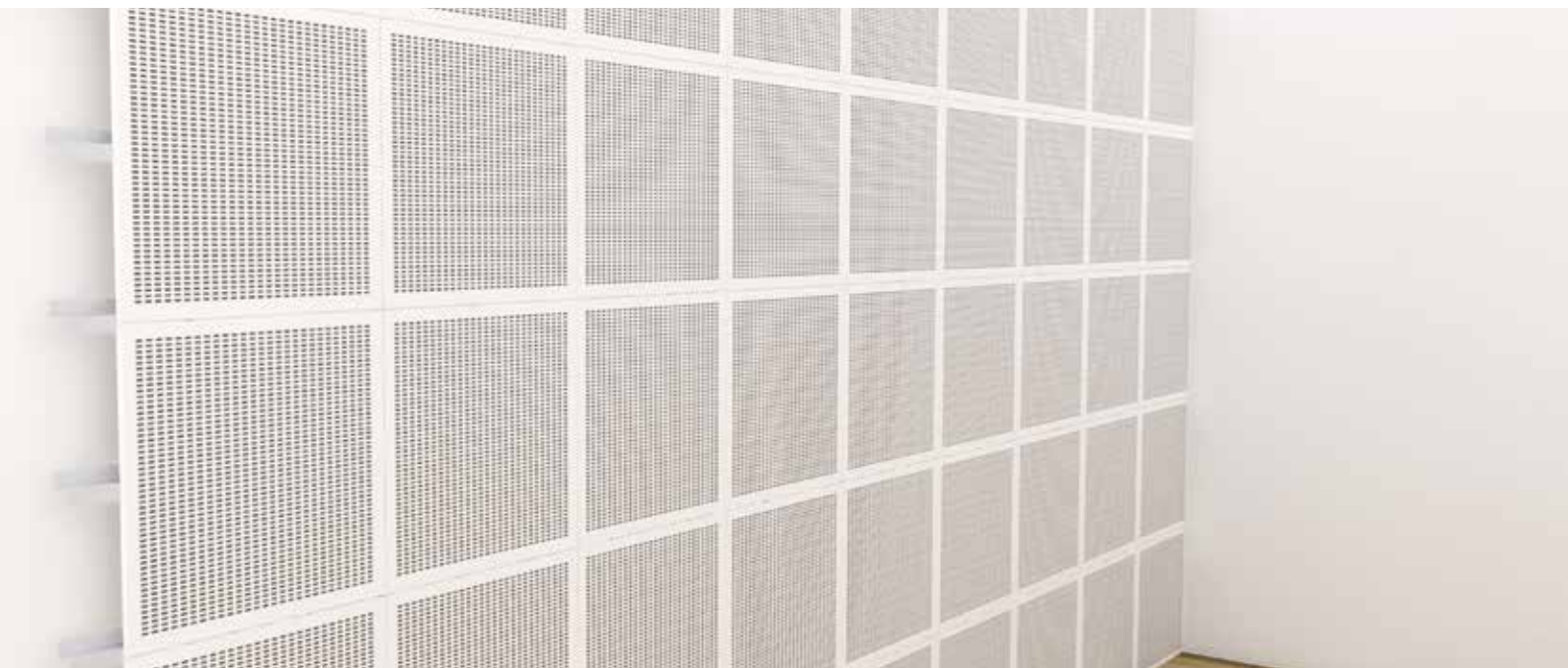

PERFORATION

Also available as Regula.

Other perforation patterns are manufactured to order.



Globe, Ø6 mm,
15 mm c/c
Perforation: 9-11%



Micro, 3 x 3 mm,
8.3 mm c/c
Perforation: 9.5-10.7%



Tangent, 4 x 14 mm,
10/20 mm c/c
Perforation: 21.1-21.3%

INSTALLATION GUIDE

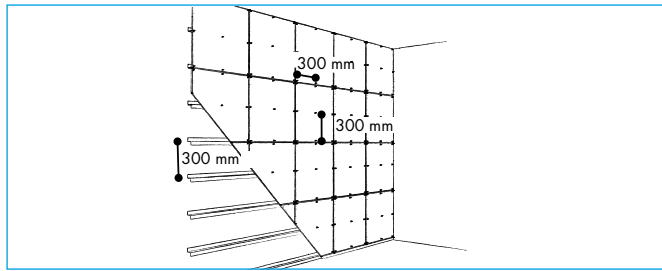
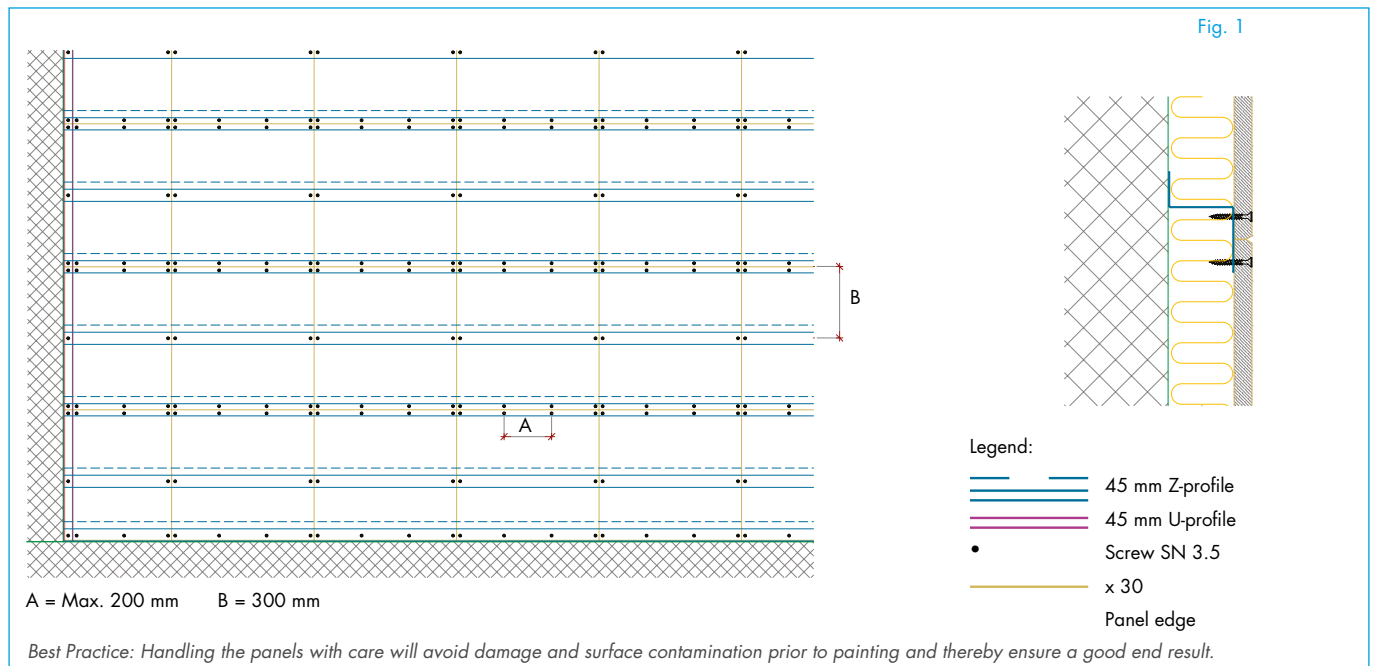

FURRING

- Tectopanel on walls can be installed on wood or steel furrings depending on current fire regulations.
- Furrings can be installed vertically or horizontally.
- Furrings should be at least 45 mm in width.
- Also see the section "Acoustics" on the next page.

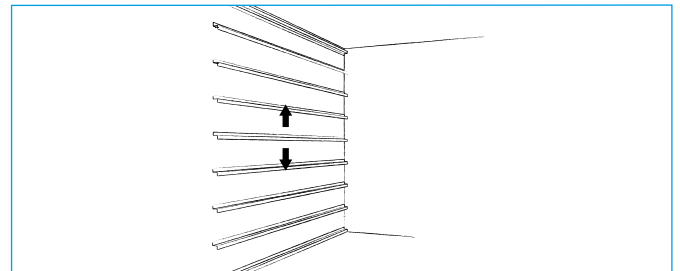

LAYOUT

- Perforated wall panels are normally installed on the upper section of a wall in accordance with acoustic requirements and the shape of the room in question.
- However, perforated panels can also be used to surface an entire wall depending on the degree of physical impact.
- Follow any available drawings or divide the surface of the wall so that the perforated modules are positioned symmetrically in the room.

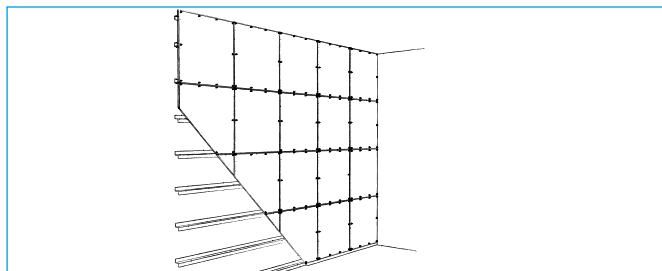

INSTALLATION

- Install the panels.
- Install the first row with the help of string.
- The panels must be flush in their own rows and at right angles to the adjacent panels.

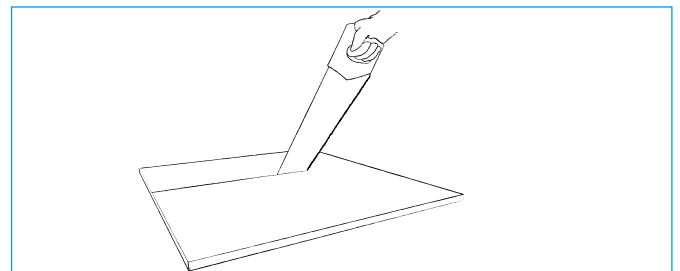

CUTTING

- Cut the elements to size from the front with a fine-toothed saw.

INSTALLATION GUIDE

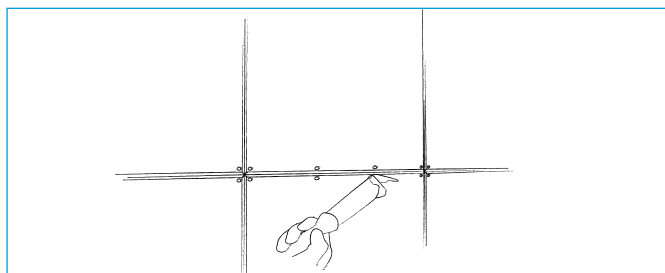

FILLING SCREW HOLES

- Check that the screws have been countersunk.
- Apply the first layer of filler (Knauf Uniflott Finish).
- Allow the filler to dry.
- Apply the second layer of filler (Knauf Uniflott Finish), overfill slightly.
- Allow the filler to dry.

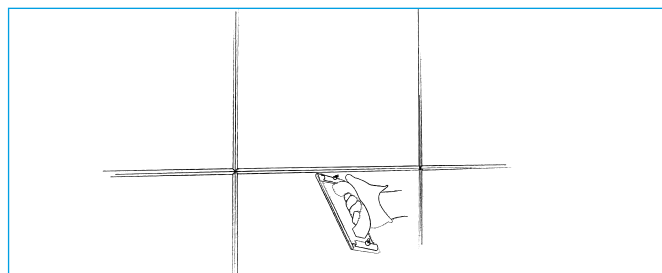

SANDING

- Make sure that the filler is completely dry.
- Sand with fine sandpaper until the surface is completely smooth. Be careful not to damage the cardboard surface.

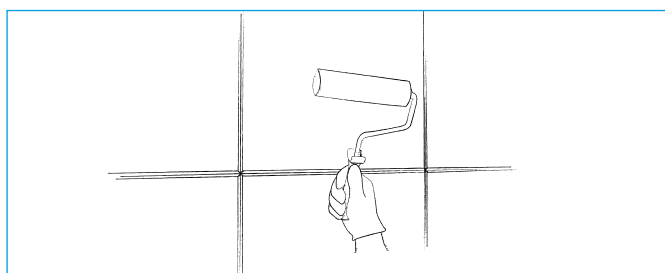

PAINTING

- Make sure that the filler is completely dry and the surface is free from dust.
- Priming should be carried out in accordance with the paint manufacturer's instructions.
- Apply the paint with a fine mohair roller.
- Make sure that the paint is not too thick and avoid applying too much paint at a time so that the acoustic felt on the perforated panels is not sealed.
- Spraying cannot be recommended as this could influence the acoustic properties of the panels.

ACOUSTICS

- A perforated gypsum panel will lose its acoustic function if the perforations are blocked (this applies to the front and back of the panel).
- Where applicable, a vapour barrier should therefore always be placed behind the furrings so that it does not come into contact with the back of the perforated panel.
- When installing Tectopanel on a fixed surface we recommend filling the cavity between the back of the panel and the furring with mineral wool. This is primarily to ensure low frequency sound absorption.

DETAILS

TECTOPANEL - INTEGRATED ACOUSTIC WALL

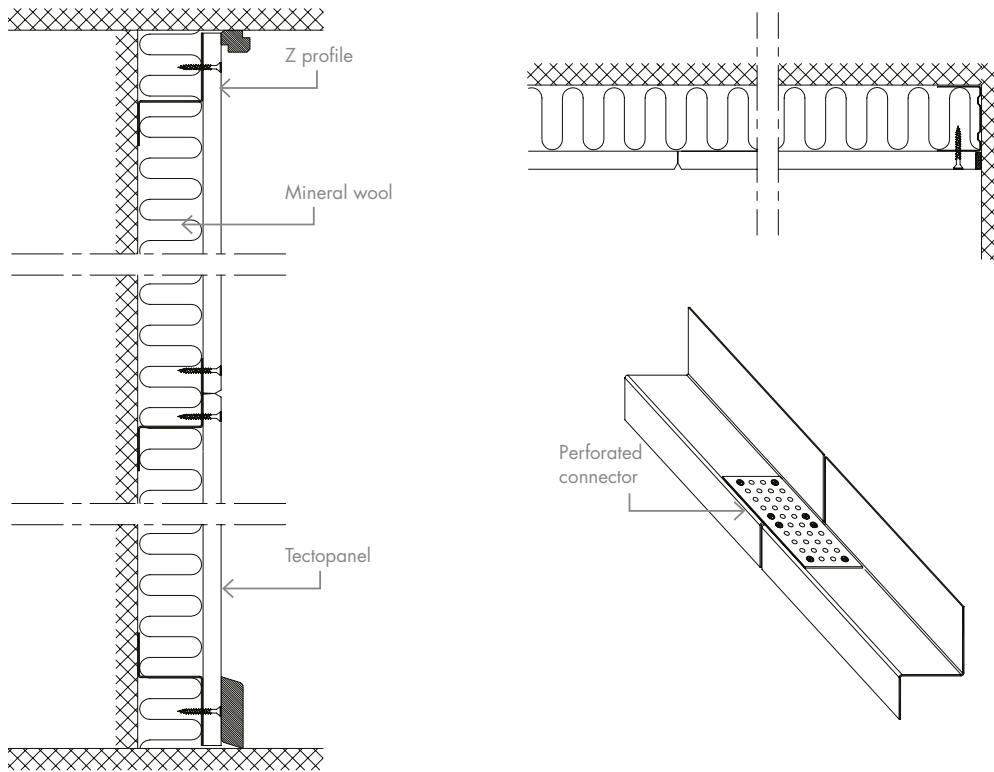

TECTOPANEL - ADD-ON ACOUSTIC WALL LINING

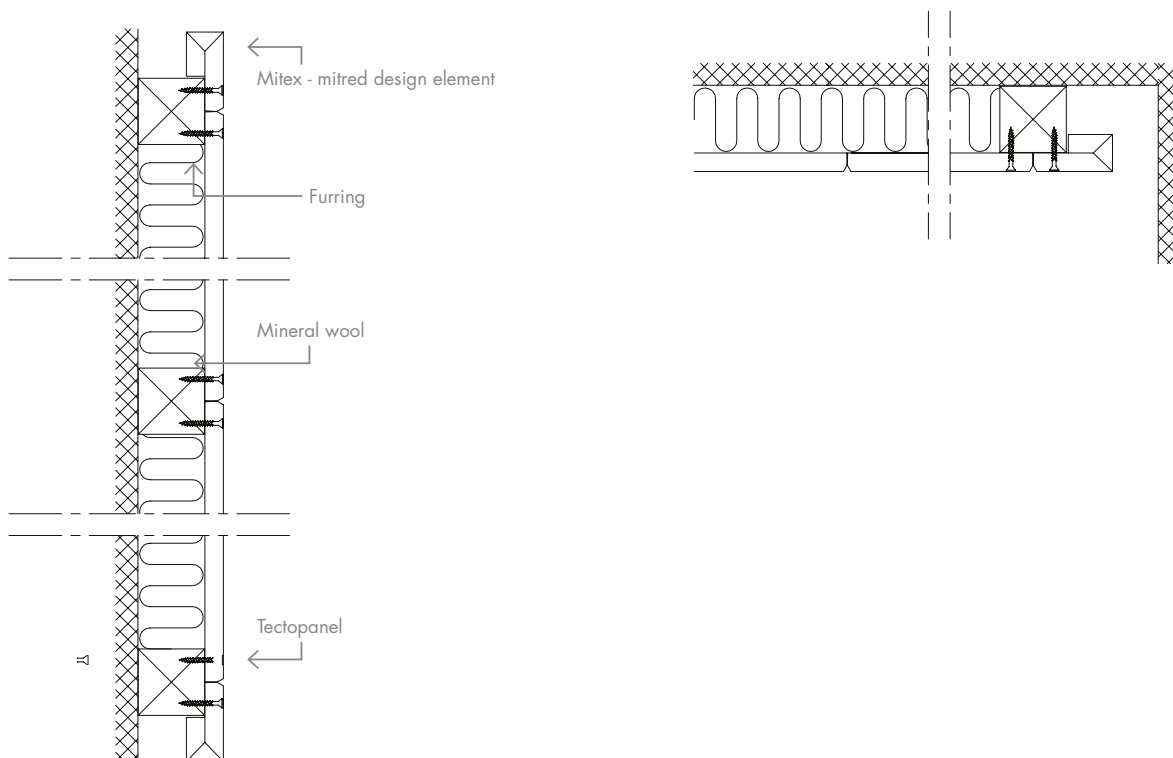

ACCESSORIES

PRODUCT NAME		SAP NO.	W x L x H (mm)
Z-profile		199089	30 x 45 x 45 x 2300
Screw (SN 3.5 x 30)		3503	3.5 x 30 mm
Uniflott Finish		129801	8 kg
Filling knife		73962	-

CURVED PANELS

Apply water on the front face and leave for 30 minutes. If necessary the panel can be covered in plastic to assist the panel in absorbing the water.

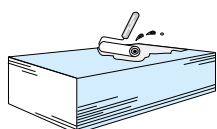

Lay the panel over a template. Secure the panel on one side of the template.

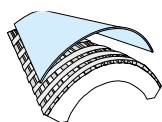

To minimize the risk of mold formation during the process, make then sure that a fast drying of the boards is present. A good ventilation with high air exchange and relative high temperature is needed and with advantage the boards can be bended and dried out before mounting.

Press the panel against the template using a batten, moving it every 100 mm.

Secure the panel on the other side of the template. Make sure that the panel is fully dry before mounting or closing the construction.

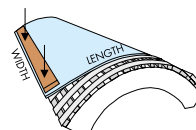

CONTRAPANEL

ACOUSTIC WALL PANELS

Acoustical performance and impact resistance in one solution. Acoustic wall lining with a distinct unified look. Foil-covered surface – easy to clean.

DID YOU KNOW THAT ...

the perforation holes in gypsum boards provide several acoustical effects: sound absorption, sound diffusion and sound reflection?

ACOUSTIC WALL PANELS

CONTRAPANEL

SIZES

600 x 1200 x 12.5 mm

Other sizes on request

SURFACE

Foil-covered with pre-impregnated white paper

Gloss 10

Tested for chemical resistance in accordance with DIN 68 861, FIRA BS 3962 and NEMA LD-3-1991

DANISH INDOOR CLIMATE LABELLING (DIM)

Indoor value: 10 days

Particle emission: low (< 0.75 mg)

CLEANING

Dust is removed using a dry duster or vacuum cleaner. Marks can be removed with a damp cloth using normal cleaning practices and neutral cleaning solutions.

AMBIENT CONDITIONS

The product is designed to perform under normal conditions of use. Tested at 90% RH and 30°C. The product can withstand ambient temperatures of up to 50°C.

LIGHT REFLECTION

Globe: 74.1%

Regula: 86.3%

FIRE CLASS

B-s1,d0

FIRE RATING

Class 1; K₁ 10, B-s1,d0; BD 30

ROBUSTNESS

Durable and dirt resistant surface. Product made of robust, glass fibre reinforced material with excellent pressure resistance. Under normal conditions of use, the product properties are preserved and there is no decomposition of material over time.

WEIGHT

Indicative tile weight: 8.50 – 9.40 kg/m².

All according to type of perforation.



CERTIFICATES

- DIN 4102-2 Fire Classification
- MPA certificate - impact resistance
- Declaration of Conformity (EN 14190)
- Danish Indoor Climate Labelling

ACOUSTIC WALL PANELS CONTRAPANEL

ACOUSTICS

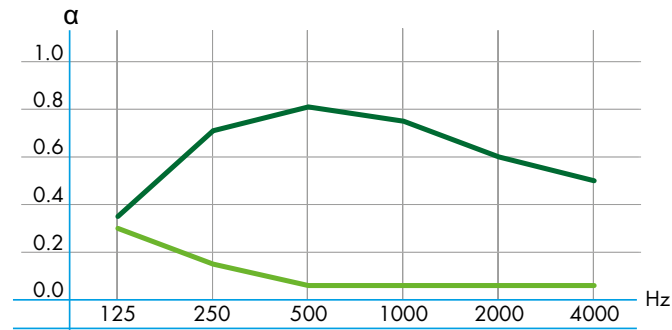

● α	0.35	0.70	0.80	0.75	0.60	0.50
● α	0.30	0.15	0.05	0.05	0.05	0.05

● Globe, 65 mm installation depth, 50 mm mineral wool α_w : 0.65, NRC: 0.70
 ● Regula, 65 mm installation depth, 50 mm mineral wool α_w : 0.10, NRC: 0.05

For acoustic data on alternative constructions please see "Absorption Data" at knaufdanoline.com

IMPACT RESISTANCE

Contrapanel is especially designed to meet the tough requirements for ceiling linings in facilities used intensively for sport, such as sport halls and gymnasiums.

The panels show no visible deformation after the tests carried out in accordance with EN 13964 or DIN 18032.

Contrapanel meets the toughest class 1 requirements in accordance with EN 13964 for impact resistant ceiling linings making the product ideal even for handball or hockey courts.

EDGES



Edge B
(bevelled edge)
Visible joints
For Globe



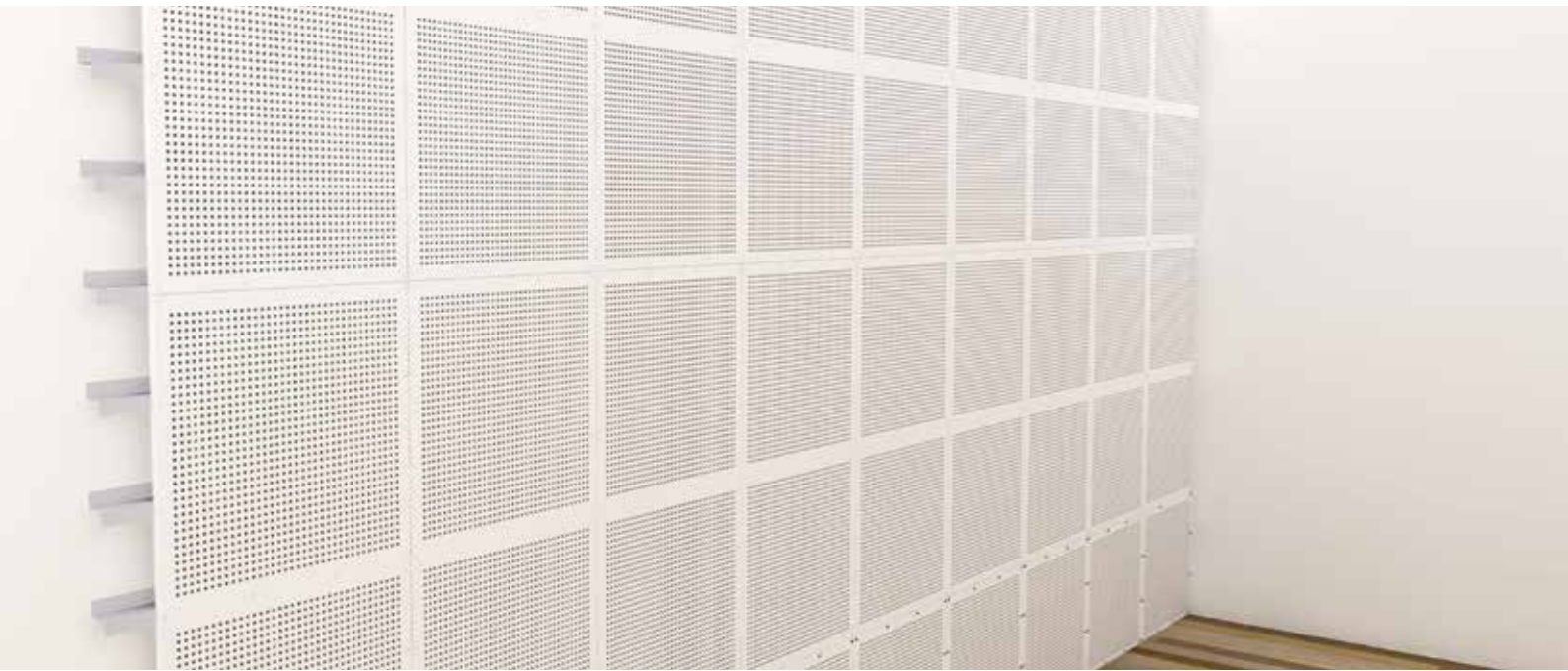

PERFORATION

Also available as Regula.



Globe, $\text{Ø}6$ mm,
15 mm c/c
Perforation G1F: 10.2%

INSTALLATION GUIDE

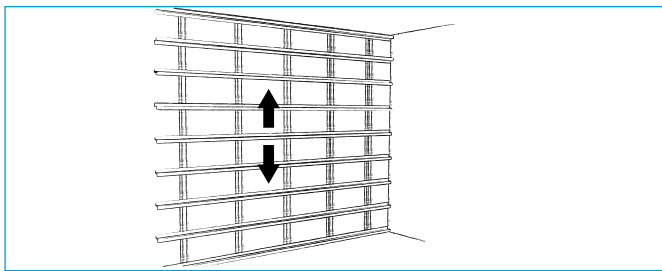
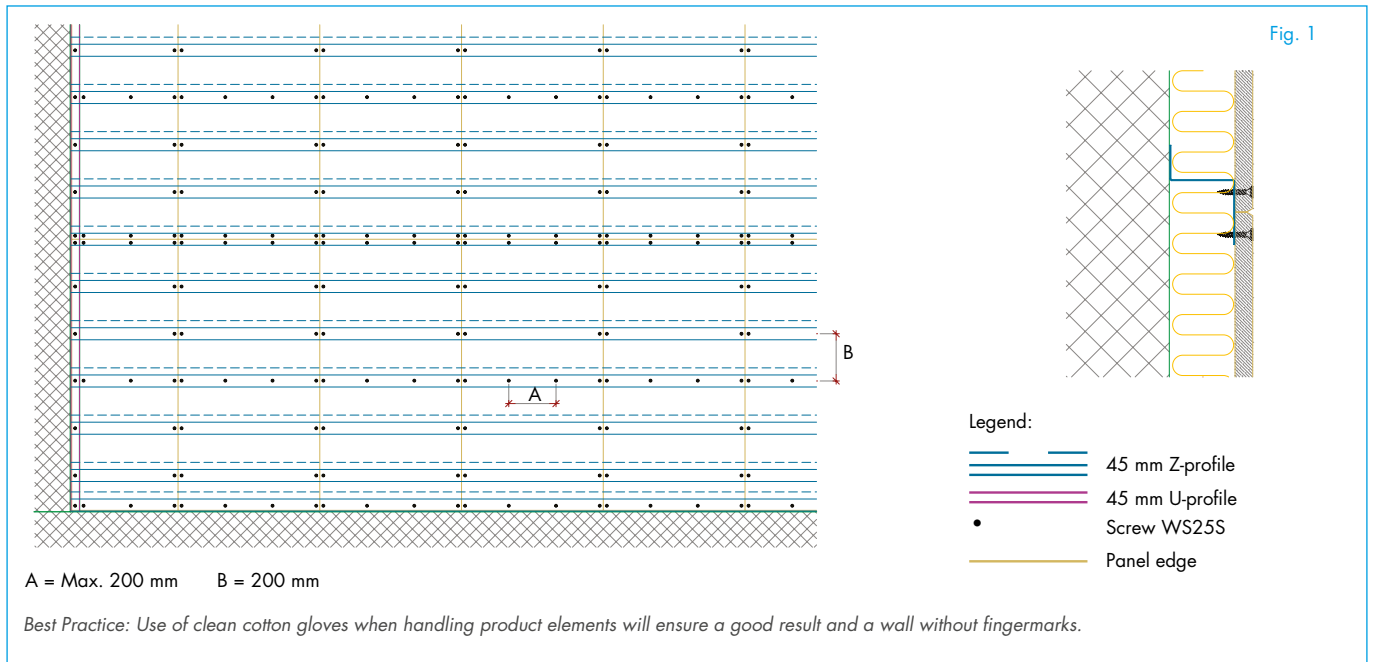

LAYOUT

- Perforated wall panels are normally installed on the upper section of a wall in accordance with acoustic requirements and the shape of the room in question.
- However, perforated panels can also be used to surface an entire wall, depending on the degree of physical impact.
- Follow any available drawings or divide the surface of the wall so that the perforated modules are positioned symmetrically in the room.
- If there are requirements on impact resistance in accordance with DIN 18 032-3, the contrapanel must be installed with two layers of panels and minimum 2 m above floor level.

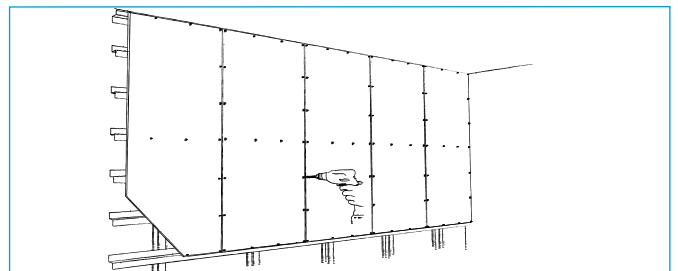

INSTALLATION

- Always wear clean cotton gloves when handling the panels.
- Mark the position of screws on the Contrapanel. Use the supplied template for this if necessary.
- Install the panels.
- Install the first row with the help of string.
- The perforated fields must be flush in their own rows and at right angles to the adjacent fields.
- Use white screws.

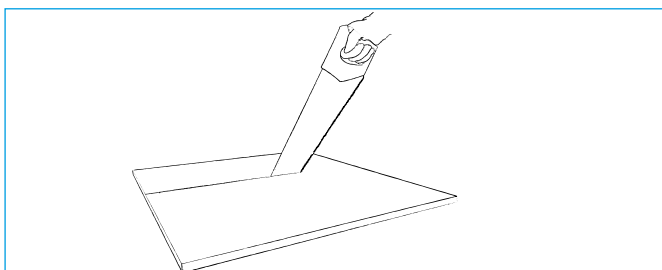

CUTTING



- Cut the elements to size from the front with a fine-toothed saw.

DETAILS

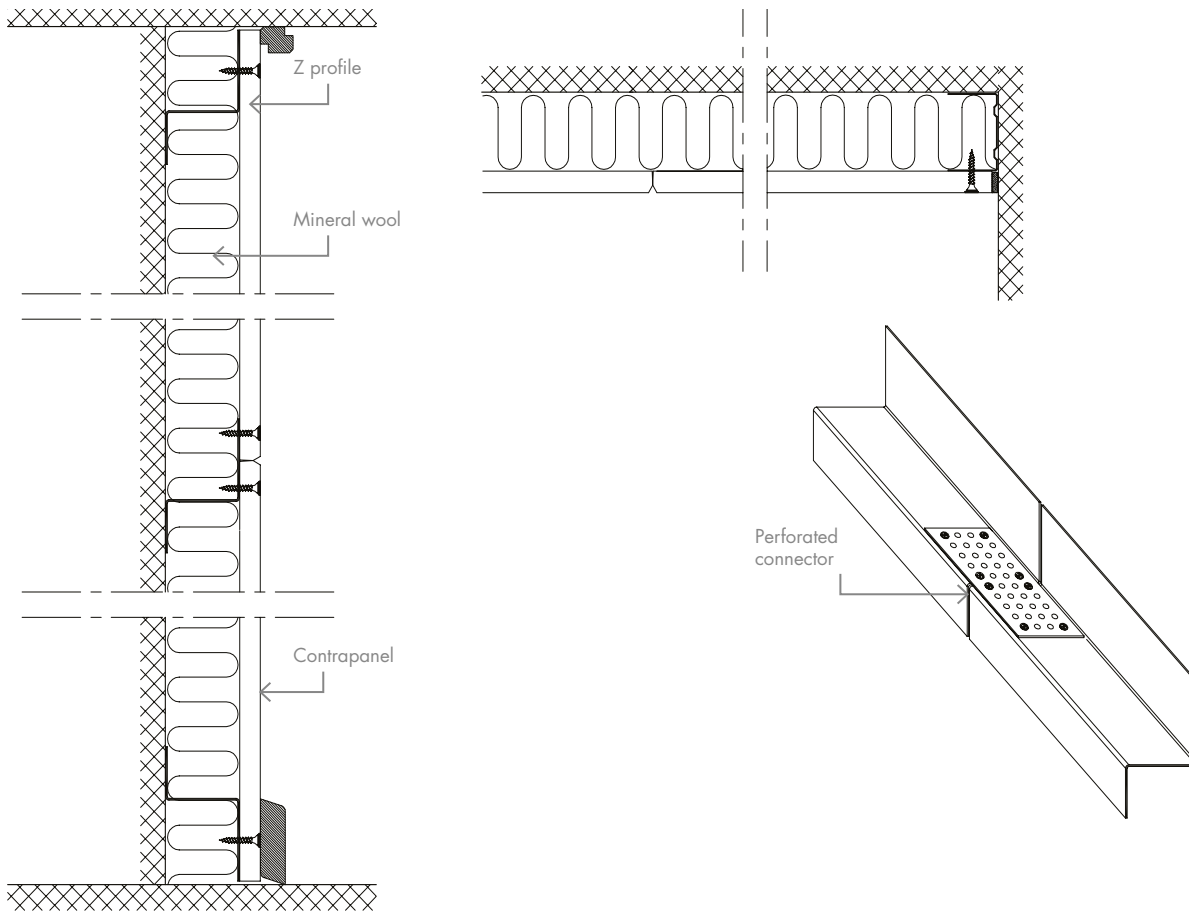
CONTRAPANEL - INTEGRATED IMPACT RESISTANT ACOUSTIC WALL

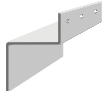
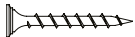
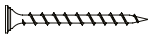
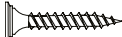

ACCESSORIES

PRODUCT NAME		SAP NO.	W x L x H (mm)
Z-profile		199089	30 x 45 x 45 x 2300
White painted screw WS32T - for 1 layer on wood		198794	32
White painted screw no 408 - for 2 layers on wood		199109	42
White painted screw WS25S - for 1 layer on steel		219774	25
White painted screw WS38S - for 2 layers on steel		219780	38

DID YOU KNOW THAT ...

22% of gypsum's mass is water bound to the gypsum crystal and ensuring the fire protective properties of gypsum boards??



SOLOPANEL

ACOUSTIC WALL PANELS

Continuous perforations to the edge offering a fluid, monolithic look. A choice of seamless or discreet joints. Acoustic gypsum lining for wall surfaces.

ACOUSTIC WALL PANELS

SOLOPANEL

SURFACE

Untreated

DANISH INDOOR CLIMATE LABELLING (DIM)

Indoor value: 10 days

Particle emission: low (< 0.75 mg)

CLEANING

Dust is removed using a dry duster or vacuum cleaner. Removal of marks depends on the paint used on site, although a damp cloth using normal cleaning practices and neutral cleaning solutions is normally suitable for minor marks. In the case of stubborn marks or if in doubt refer to the paint manufacturer's recommendations.

LIGHT REFLECTION

Depends on the paint used on site.

AMBIENT CONDITIONS

The product is designed to perform under normal conditions of use. Tested at 90% RH and 30°C. The product can withstand ambient temperatures of up to 50°C.

FIRE CLASS

A2-s1,d0

ROBUSTNESS

Made of robust, glass fibre reinforced material with excellent pressure resistance. Under normal conditions of use, the product properties are preserved and there is no decomposition of material over time.

WEIGHT

Indicative tile weight: 8.30 – 9.00 kg/m².

All according to type of perforation.

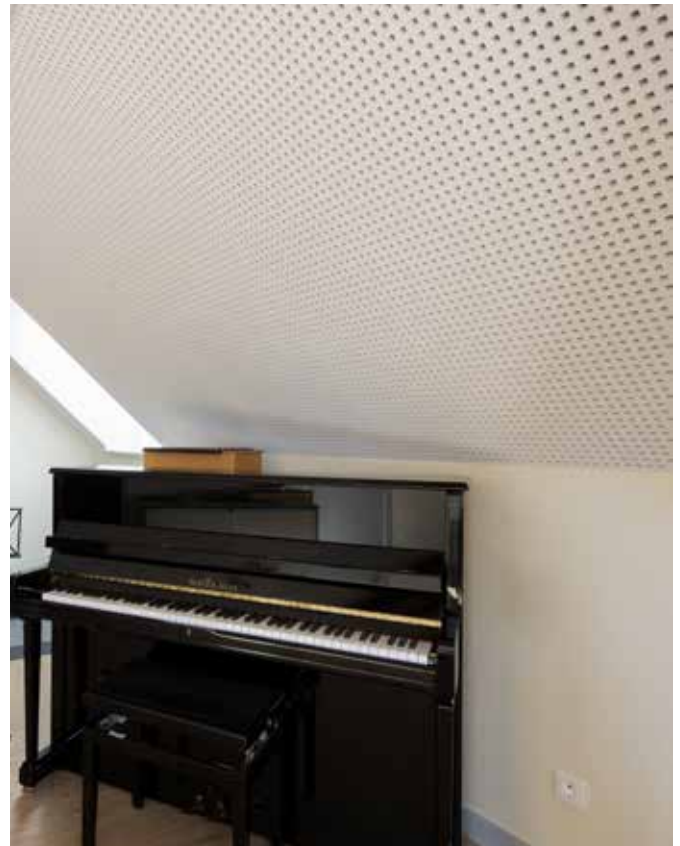

CERTIFICATES

- Declaration of Conformity (EN 14190)
- Danish Indoor Climate Labelling

ACOUSTIC WALL PANELS SOLOPANEL

ACOUSTICS

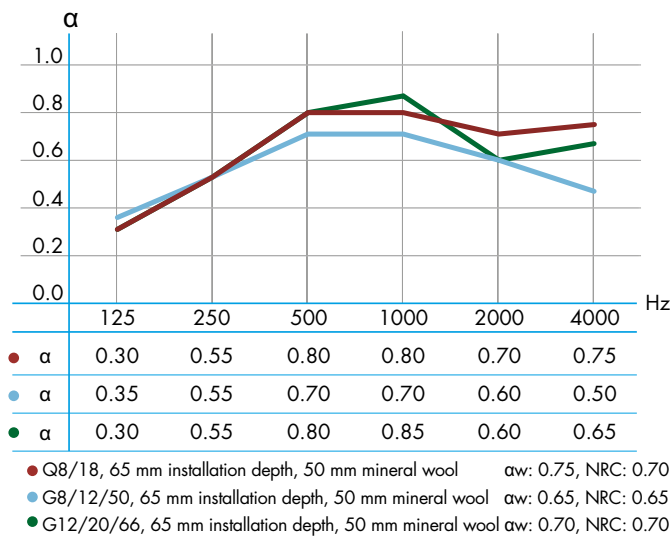
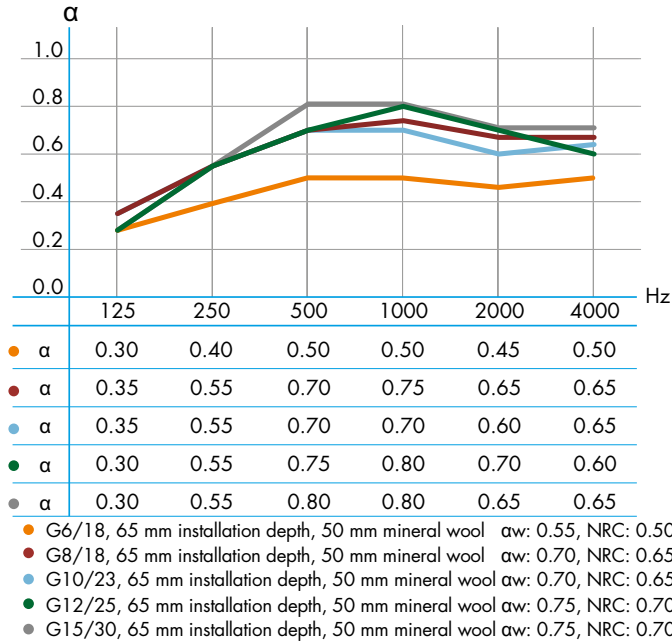

For acoustic data on alternative constructions please see "Absorption Data" at knaufdanoline.com

EDGES



Edge SK
No visible joints

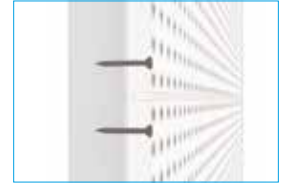

Edge UFF
No visible joints



Edge MF
Discreet joint



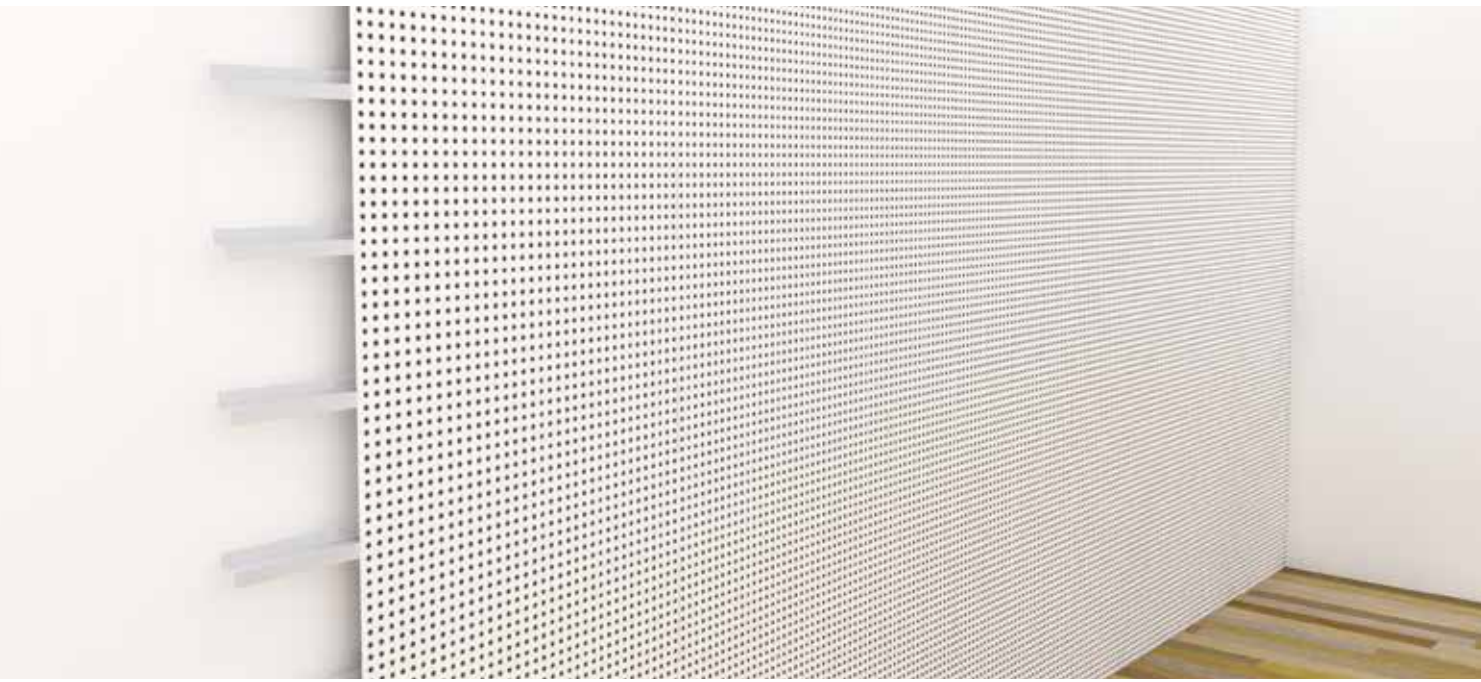

PERFORATION

PERFORATION TYPE	PERFORATION PERCENTAGE	 EDGE UFF SIZES
G 6/18	8.7 %	1188 x 1998 mm
G 8/18	15.5 %	1188 x 1998 mm
G 10/23	14.8 %	1196 x 2001 mm
G 12/25	18.1 %	1200 x 2000 mm
G 15/30	19.6 %	1200 x 1980 mm
Q 8/18	19.8 %	1188 x 1998 mm
Q 12/25	23 %	1200 x 2000 mm
G 8/12/50	13.1 %	1200 x 2000 mm
G12/20/66	19.6 %	1188 x 1980 mm

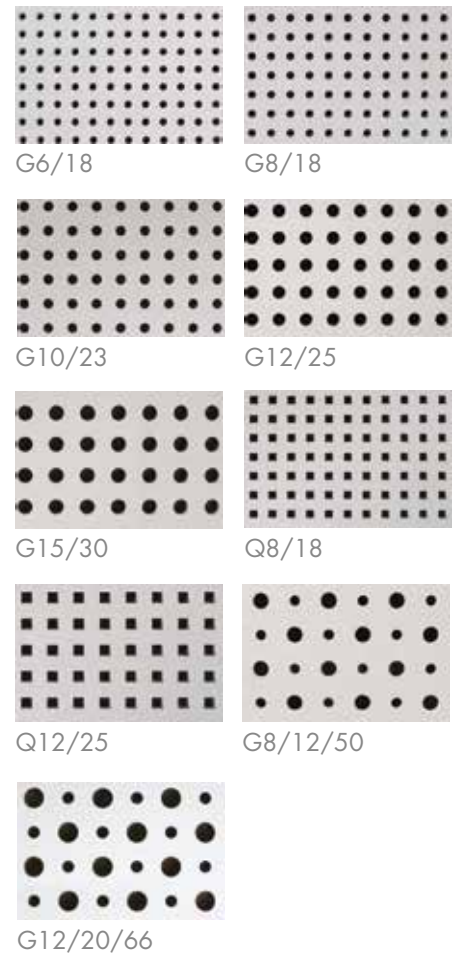

* Some perforations can also be supplied with a SK or a MF edge. Exact panel sizes vary from module sizes according to edge type. Contact Knaf Danoline for more information.

INSTALLATION GUIDE

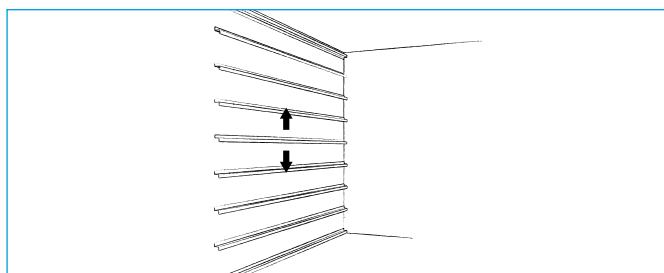
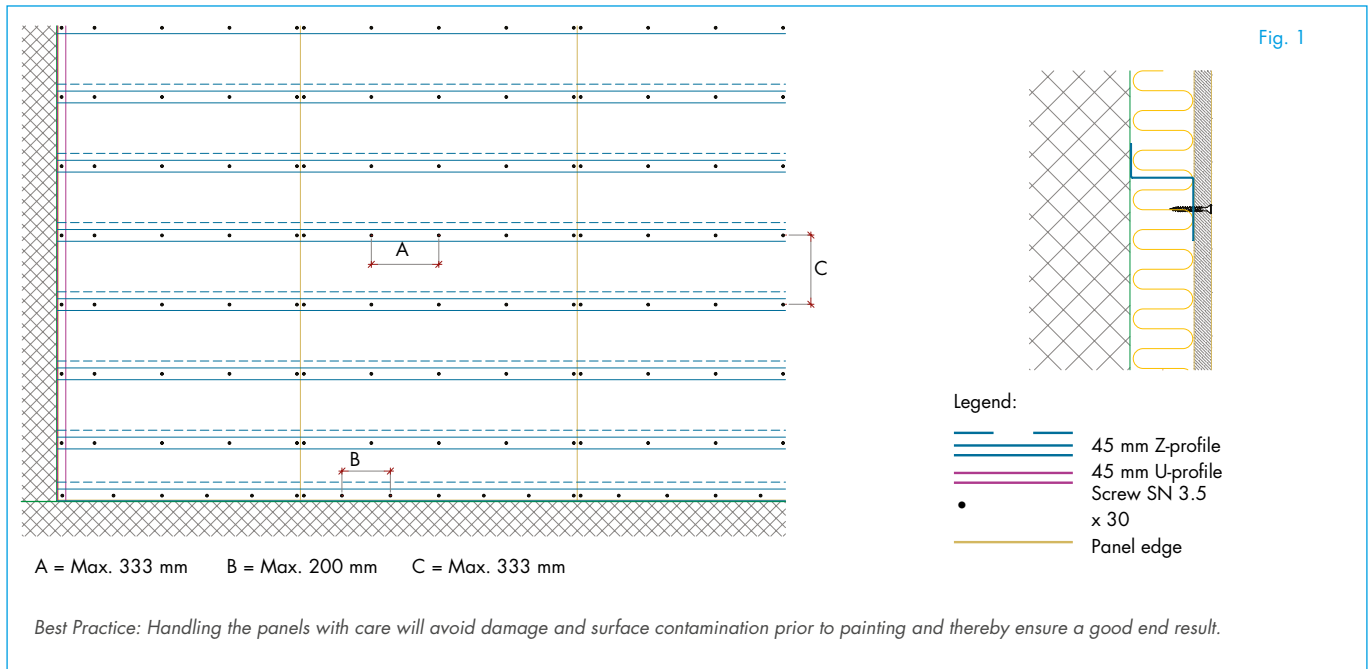

LAYOUT

- Perforated wall panels are normally installed on the upper section of a wall in accordance with acoustic requirements and the shape of the room in question.
- However, perforated panels can also be used to surface an entire wall depending on the degree of physical impact.
- Please note that expansion joints must be established on extensive ceiling surfaces at max. intervals of 15 metres in both directions. See detailed drawings at knaufdanoline.com.

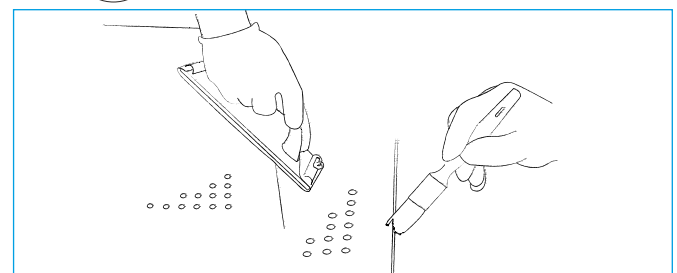
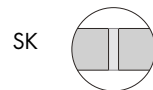

PREPARING PANELS

- Break all edges with fine sandpaper on the front so that the cardboard cannot rise.
- Prime the edges with Knauf Tiefengrund (universal primer).

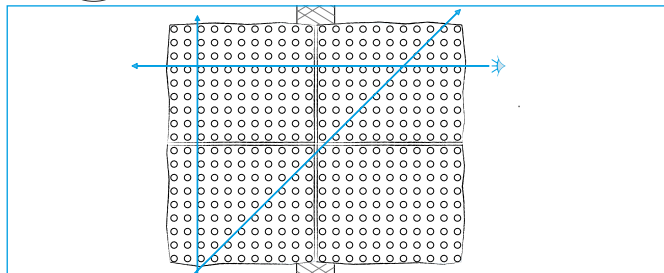
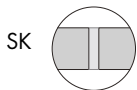

POSITIONING

- SK panels are supplied undersized, and must be installed at distances of 2-5 mm from each other to ensure that it is possible to insert filler all the way up between the edges.
- Ensure the correct distance between perforation rows at the joints. The perforation rows have to align crosswise and diagonally.

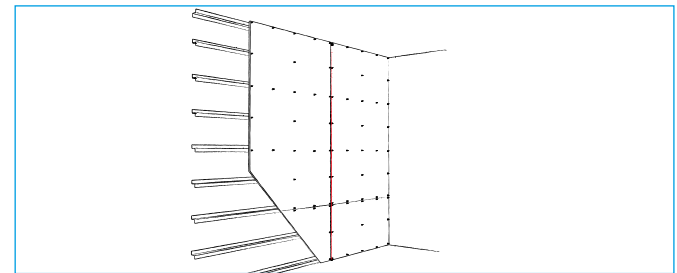

INSTALLATION

- Install the panels so that they all face in the same direction (**red mark against blue mark**).
- Install the first row with the help of string.
- Fasten panels with Screw SN3.5x30.

INSTALLATION GUIDE

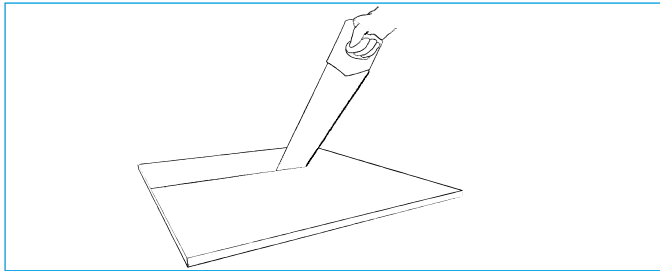
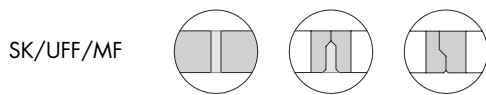

CUTTING

- Cut the elements to size from the front with a fine-toothed saw.
- Prime the edges with Knauf Tiefengrund (universal primer).

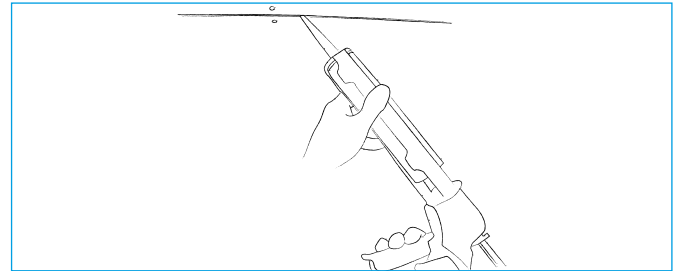
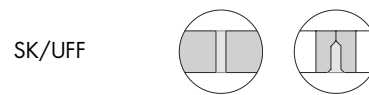

FILLING

- Check that the screws are countersunk and that the panels are not pushed close together.
- Check that the edges have been primed and are free from dust.
- Use Knauf Uniflott for filling.
- Prime the edges with Knauf Tiefengrund (universal primer).

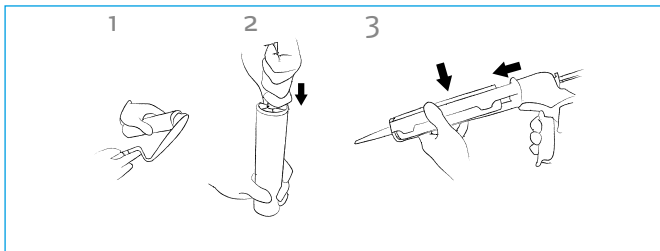
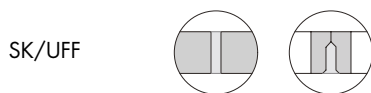

PREPARING KNAUF UNIFLOTT FILTER

- Prepare the filler according to the instructions on the filling package.
- Fill the tube with joint filler with the help of a putty knife.
- Attach the jointing nozzle.
- Insert the tube and nozzle into a jointing gun.

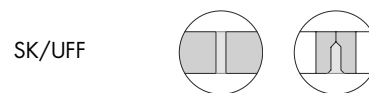

FILLING

- Fill the joint with filler (Knauf Uniflott). Use a jointing gun or press the filler into the joint with a filling knife. Overfill slightly and make sure that the filler is pressed all the way up between the edges of the panels and avoid getting filler in the perforations.
- Press the filler up again by running a finger over the joint. Fill again.
- Allow the filler to dry for about 45 minutes.
- Remove surplus filler.
- Allow the filler to dry.
- Apply the second layer of filler (Knauf Uniflott Finish). Overfill slightly.
- Allow the filler to dry.

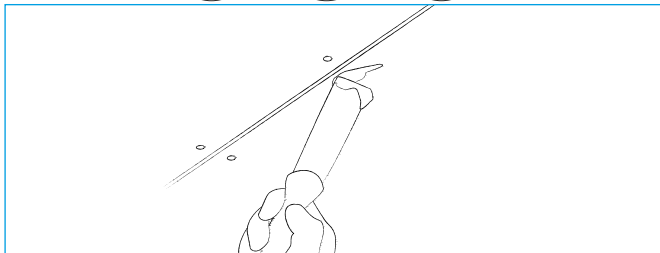
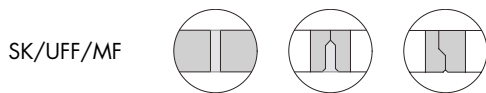

FILLING SCREW HOLES

- Apply the filler (Knauf Uniflott Finish). Overfill slightly. We recommend the use of Knauf Danogips „Acoustic filling knife for holes“ in order to avoid filler getting into the perforation holes.
- Allow the filler to dry.

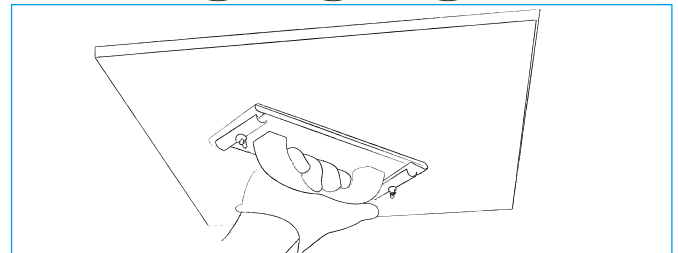
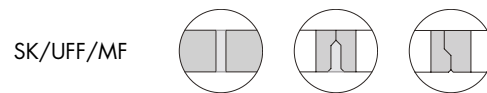

SANDING

- Make sure that the filler is completely dry.
- Sand with fine sandpaper until the surface is completely smooth. Be careful not to damage the cardboard surface.

INSTALLATION GUIDE

SK/UFF/MF

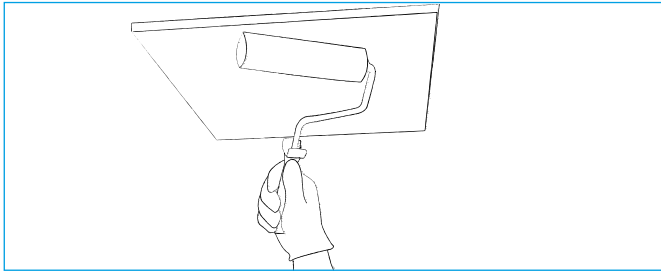
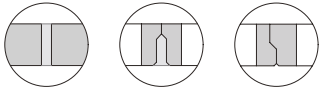

PAINTING





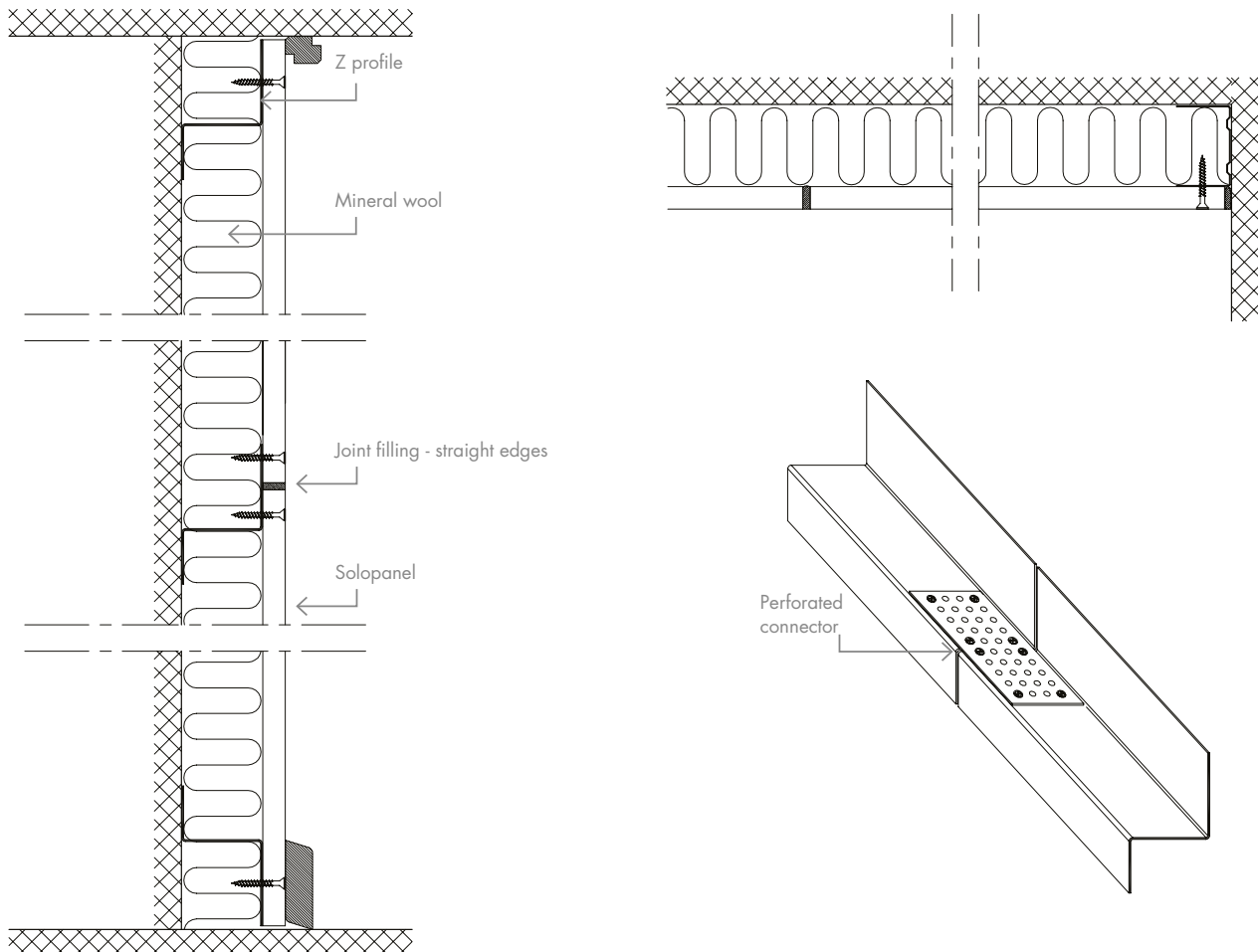

- Make sure that the filler is completely dry and the surface is smooth and free from dust.
- Priming should be carried out in accordance with the paint manufacturer's instructions.
- Apply the paint with a roller so that the acoustic felt on the perforated panels is not sealed. Use a fine mohair roller.
- Make sure that the paint is not too thick and avoid applying too much paint at a time.

DETAILS

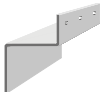
SOLOPANEL - INTEGRATED ACOUSTIC WALL

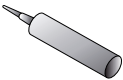

ACCESSORIES

PRODUCT NAME		SAP NO.	W x L x H (mm)
Z-profile		199089	30 x 45 x 45 x 2300
Screw SN 3.5x30		3503	3.5 x 30
Knauf Tiefengrund (Universal Primer)		253759	5 L
Unflott Finish		129801	8 kg
Knauf Uniflott		253631	25 kg
		253630	5 kg
Filler tube set		4707	-
Filling knife		73962	-

STRATOPANEL

ACOUSTIC WALL PANELS

Continuous random perforation pattern offering a fluid, monolithic look. Seamless lining for wall surfaces.

DID YOU KNOW THAT ...

Danoline products is high grade glass fibre reinforced?

ACOUSTIC WALL PANELS

STRATOPANEL

SURFACE

Untreated

DANISH INDOOR CLIMATE LABELLING (DIM)

Indoor value: 10 days

Particle emission: low (< 0.75 mg)

CLEANING

Dust is removed using a dry duster or vacuum cleaner. Removal of marks depends on the paint used on site, although a damp cloth using normal cleaning practices and neutral cleaning solutions is normally suitable for minor marks. In the case of stubborn marks or if in doubt refer to the paint manufacturer's recommendations.

LIGHT REFLECTION

Depends on the paint used on site.

AMBIENT CONDITIONS

The product is designed to perform under normal conditions of use. Tested at 90% RH and 30°C. The product can withstand ambient temperatures of up to 50°C.

FIRE CLASS

A2-s1,d0

ROBUSTNESS

Made of robust, glass fibre reinforced material with excellent pressure resistance. Under normal conditions of use, the product properties are preserved and there is no decomposition of material over time.

WEIGHT

Indicative tile weight: 8.00 – 9.30 kg/m².

All according to type of perforation.

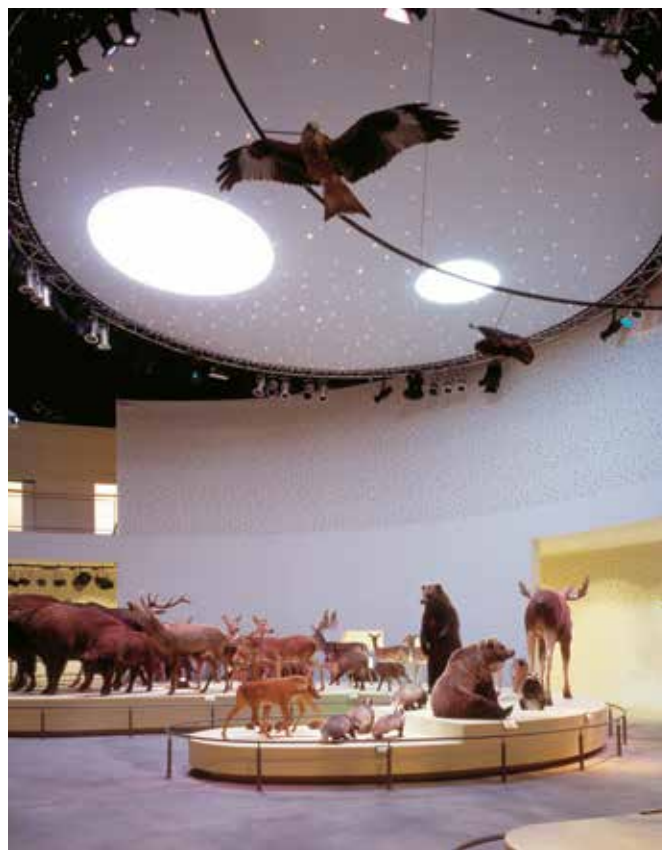

CERTIFICATES

- Declaration of Conformity (EN 14190)
- Danish Indoor Climate Labelling

ACOUSTIC WALL PANELS STRATOPANEL

ACOUSTICS

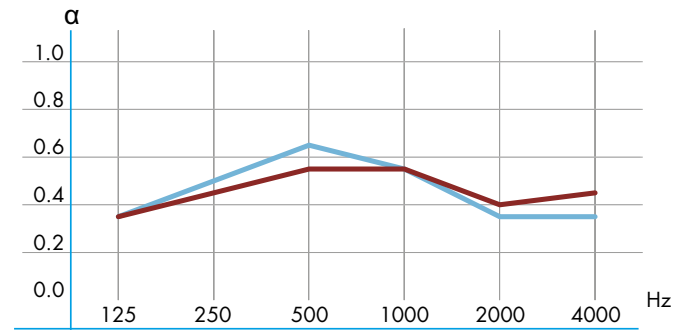

	125	250	500	1000	2000	4000
● α	0.35	0.45	0.55	0.55	0.40	0.45
● α	0.35	0.50	0.65	0.55	0.35	0.35

● G8/15/20, 65 mm installation depth, 50 mm mineralwool, α_w : 0.50, NRC: 0.50

● G12/20/35, 65 mm installation depth, 50 mm mineralwool, α_w : 0.45, NRC: 0.50

EDGES



Edge SK

No visible joints



Edge UFF

No visible joints

For acoustic data on alternative constructions please see "Absorption Data" at knaufdanoline.com



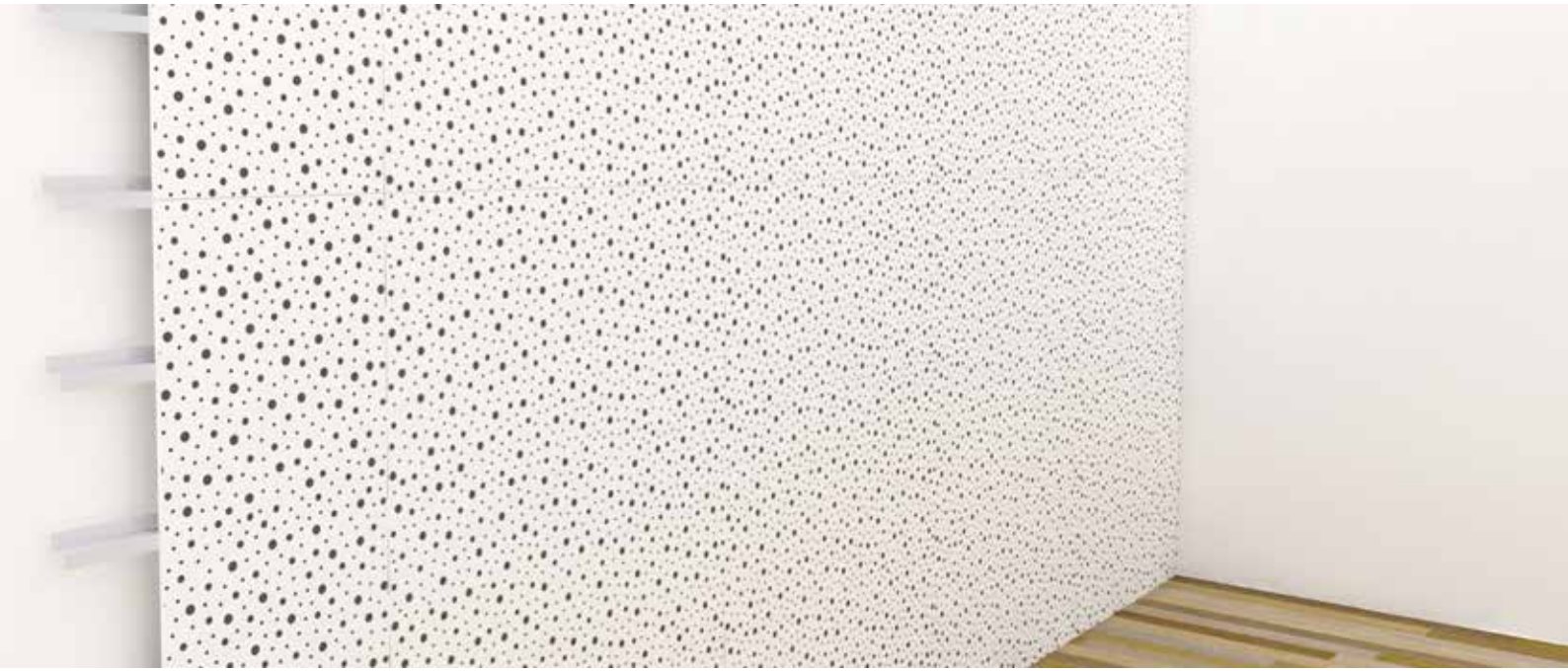

PERFORATION

PERFORATION TYPE	PERFORATION PERCENTAGE	EDGE UFF SIZES
G8/15/20	9.9 %	1200 x 2000 or 1200 x 2500 mm
G12/20/35	9.8 %	1200 x 1875 or 1200 x 2500 mm

* Some perforations can also be supplied with a SK edge.
Exact panel sizes vary from module sizes according to edge type.
Contact Knauf Danoline for more information.



Edge SK



G8/15/20

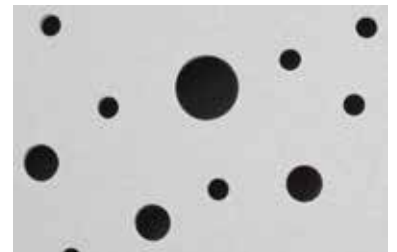

G12/20/35

INSTALLATION GUIDE

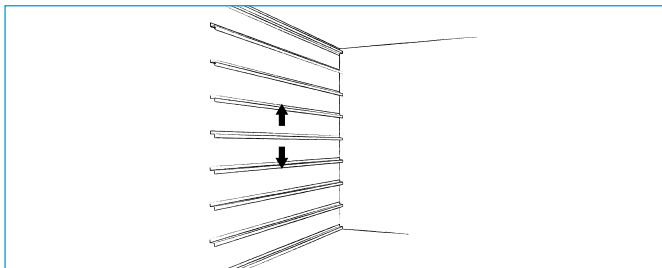
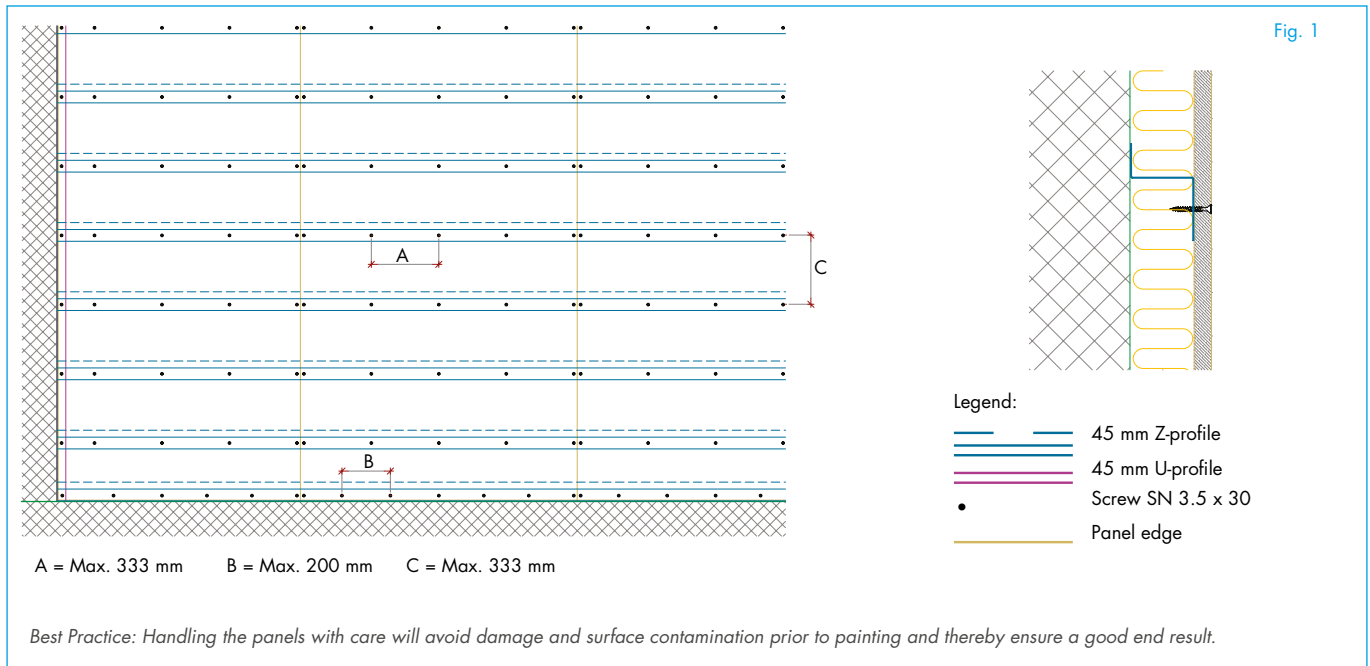

LAYOUT

- Perforated wall panels are normally installed on the upper section of a wall in accordance with acoustic requirements and the shape of the room in question.
- However, perforated panels can also be used to surface an entire wall depending on the degree of physical impact.
- Please note that expansion joints must be established on extensive ceiling surfaces at max. intervals of 15 metres in both directions. See detailed drawings at knaufdanoline.com.

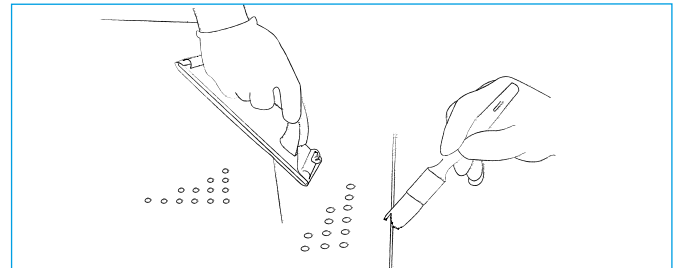

PREPARING PANELS

- Break all edges with fine sandpaper on the front so that the cardboard cannot rise.
- Prime the edges with Knauf Tiefengrund (universal primer).

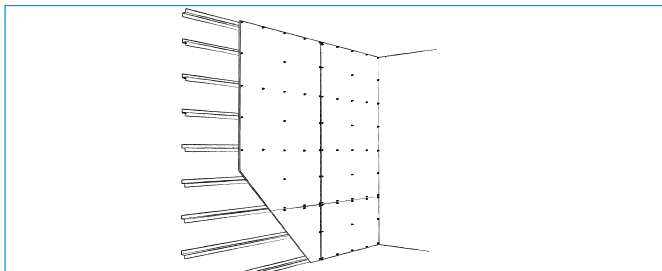

INSTALLATION

- Install the panels so that they all face in the same direction (**red mark against blue mark**).
- Install the first row with the help of string.
- Fasten panels with Screw SN3.5x30.

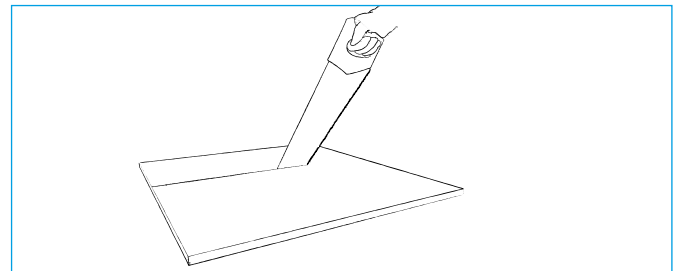

CUTTING

- Cut the elements to size from the front with a fine-toothed saw.
- Prime the edges with Knauf Tiefengrund (universal primer).

INSTALLATION GUIDE

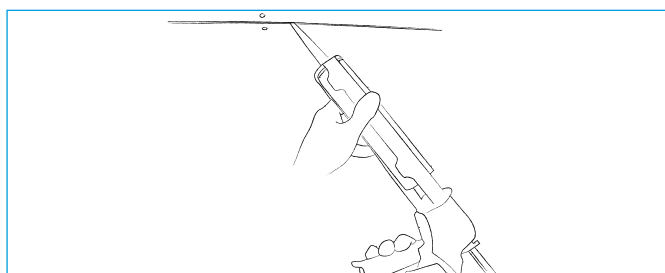

FILLING

- Check that the screws are countersunk and that the panels are not pushed close together.
- Check that the edges have been primed and are free from dust.
- Use Knauf Uniflott for filling.

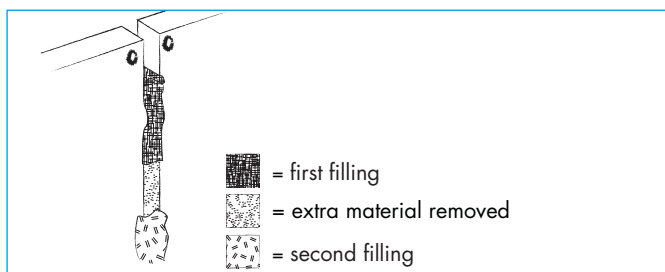

FILLING

- Fill the joint with filler (Knauf Uniflott). Use a jointing gun or press the filler into the joint with a filling knife. Overfill slightly and make sure that the filler is pressed all the way up between the edges of the panels and avoid getting filler in the perforations.
- Press the filler up again by running a finger over the joint. Fill again.
- Allow the filler to dry for about 45 minutes.
- Remove surplus filler.
- Allow the filler to dry.
- Apply the second layer of filler (Knauf Uniflott Finish). Overfill slightly.
- Allow the filler to dry.

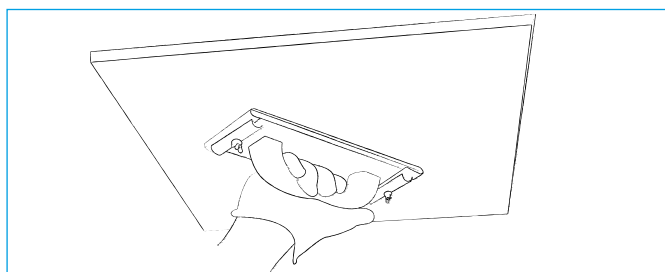

SANDING

- Make sure that the filler is completely dry.
- Sand with fine sandpaper until the surface is completely smooth. Be careful not to damage the cardboard surface.

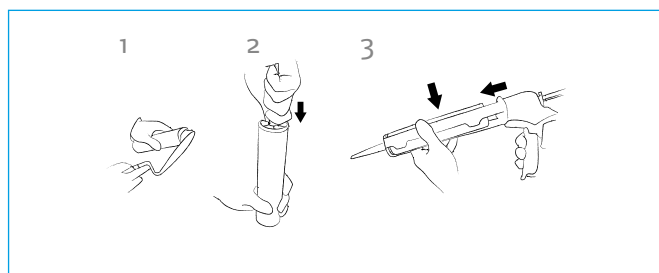

PREPARING KNAUF UNIFLOTT FILTER

- Prepare the filler according to the instructions on the filling package.
- Fill the tube with joint filler with the help of a putty knife.
- Attach the jointing nozzle.
- Insert the tube and nozzle into a jointing gun.

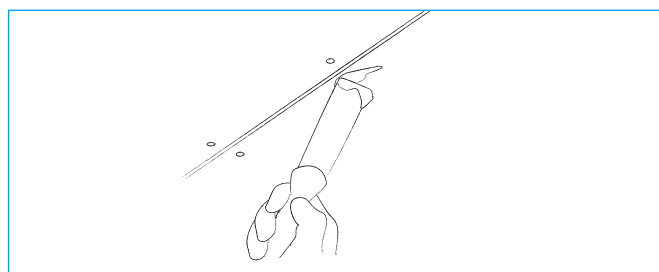

FILLING SCREW HOLES

- Apply the filler (Knauf Uniflott Finish). Overfill slightly. We recommend the use of Knauf Danogips „Acoustic filling knife for holes“ in order to avoid filler getting into the perforation holes.
- Allow the filler to dry.

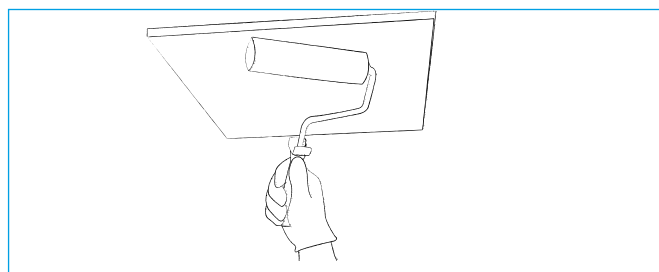

PAINTING





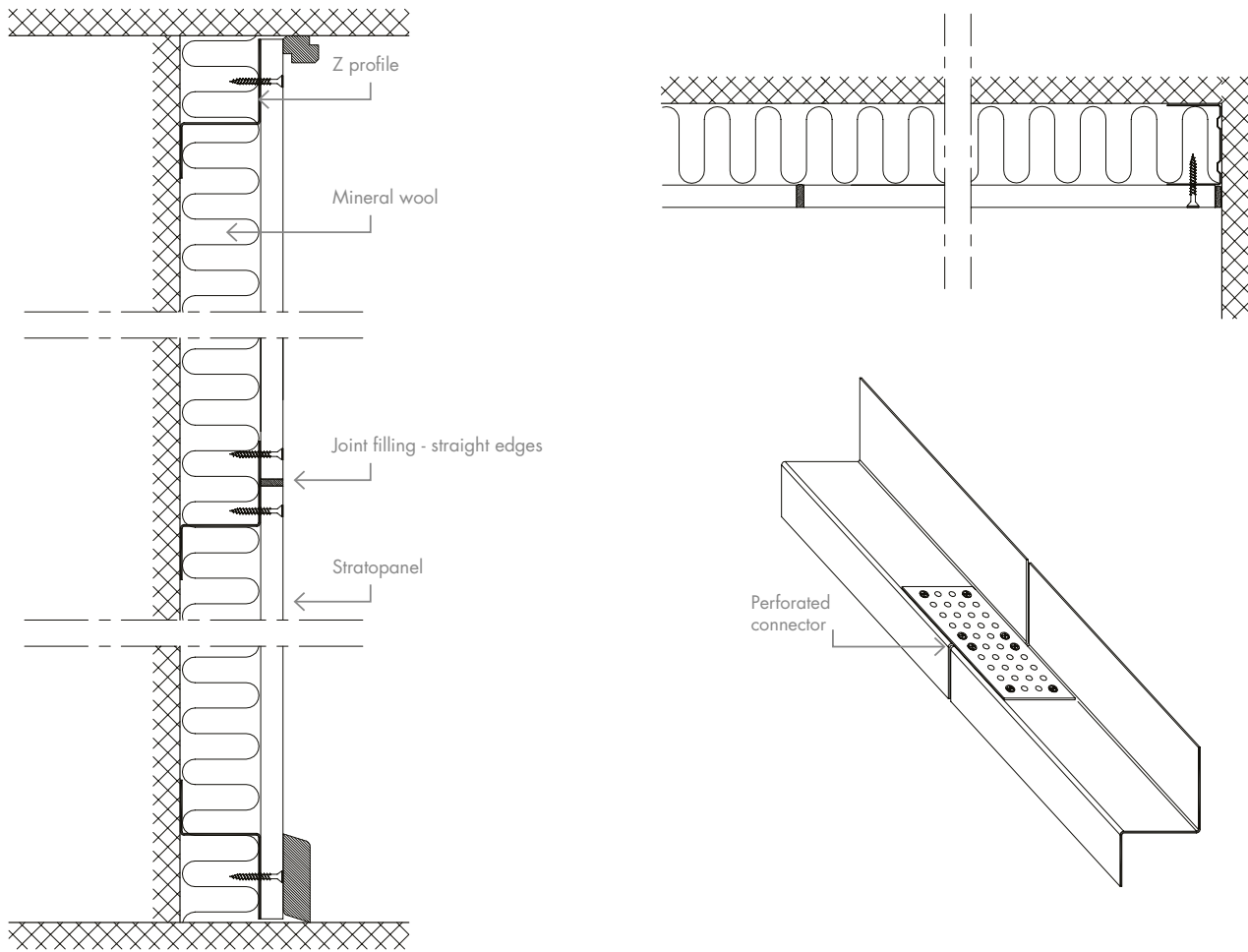

- Make sure that the filler is completely dry and the surface is smooth and free from dust.
- Priming should be carried out in accordance with the paint manufacturer's instructions.
- Apply the paint with a roller so that the acoustic felt on the perforated panels is not sealed. Use a fine mohair roller.
- Make sure that the paint is not too thick and avoid applying too much paint at a time.

DETAILS

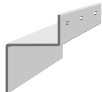
STRATOPANEL - INTEGRATED ACOUSTIC WALL

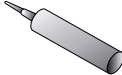

ACCESSORIES

PRODUCT NAME		SAP NO.	W x L x H (mm)
Z-profile		199089	30 x 45 x 45 x 2300
Screw SN 3.5x30		3503	3.5 x 30
Knauf Tiefengrund (Universal Primer)		253759	5 L
Uniflott Finish		129801	8 kg
Knauf Uniflott		253631	25 kg
		253630	5 kg
Filler tube set		4707	-
Filling knife		73962	-

Architect: HOMECO + Gro Fuggibaggi Design, Bergen Kino, Norway, Kinopanel upe Eau

DID YOU KNOW THAT ...

perforated gypsum boards use sound resonance or counter-sound to enhance sound absorption?

KINOPANEL

ACOUSTIC WALL PANELS

Special acoustic wall lining for cinemas and other entertainment premises requiring excellent sound diffusion. Discreet unified look with elegant oval perforations.

ACOUSTIC WALL PANELS

KINOPANEL

SIZES

600 x 600 x 12.5 mm

600 x 900 x 12.5 mm

SURFACE

Standard black painted surface NCS S9000-N (gloss 5)

Robust, dirt resistant and exceptionally easy to clean.

Other colours available on request.

DANISH INDOOR CLIMATE LABELLING (DIM)

Indoor value: 10 days

Particle emission: low (< 0.75 mg)

CLEANING

Dust is removed using a dry duster or vacuum cleaner. Marks can be removed with a damp cloth using normal cleaning practices and neutral cleaning solutions.

AMBIENT CONDITIONS

The product is designed to perform under normal conditions of use. Tested at 70% RH and 25°C. The product can withstand ambient temperatures of up to 50°C.

FIRE CLASS

A2-s1,d0

ROBUSTNESS

Made of robust, glass fibre reinforced material with excellent pressure resistance. Under normal conditions of use, the product properties are preserved and there is no decomposition of material over time.

WEIGHT

Indicative tile weight: 6.20 kg/m².



CERTIFICATES

- Declaration of Conformity (EN 14190)
- Danish Indoor Climate Labelling

ACOUSTIC WALL PANELS KINOPANEL

ACOUSTICS

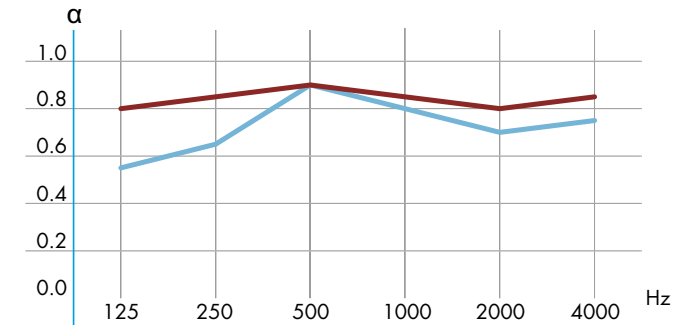

● α	0.55	0.65	0.90	0.80	0.70	0.75
● α	0.80	0.85	0.90	0.85	0.80	0.85
● Kino, 85 mm installation depth, 50 mm mineral wool	aw: 0.80, NRC: 0.75					
● Kino, 135 mm installation depth, 100 mm mineral wool	aw: 0.85, NRC: 0.85					

EDGES



Edge B
(Bevelled edge)
Visible joints

For acoustic data on alternative constructions please see "Absorption Data" at knaufdanoline.com





PERFORATION



Kino perforation is a special perforation designed for cinemas and other entertainment premises.

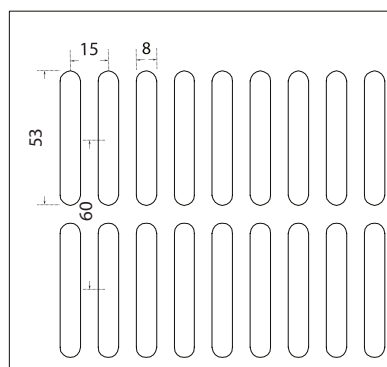

Kino, 8x53 mm,
5/60 mm c/c
Perforation 36.9%

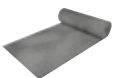

ACCESSORIES

PRODUCT NAME		SAP NO.	W x L x H
Rubber plug		198917	-
Screw SN 3.5x30		3503	3.5 x 30 mm
Kino felt		592361	1.26 x 100 m

INSTALLATION GUIDE

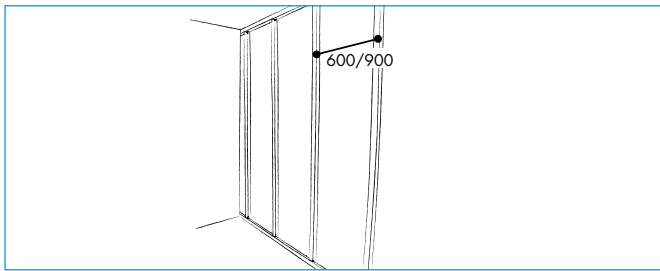
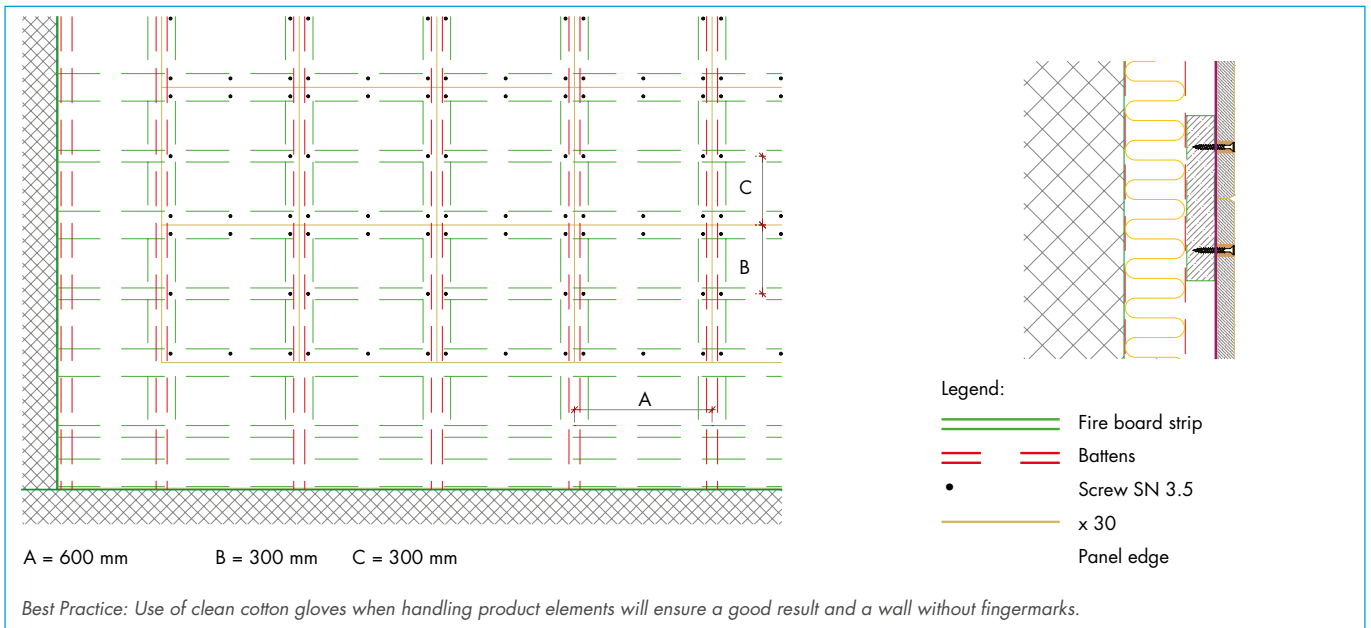

FURRING

- Fix 50 x 50 mm or 50 x 100 mm wooden furring vertically at 600 mm intervals.
- The furring must be placed vertically precisely in relation to the joint between the panels.

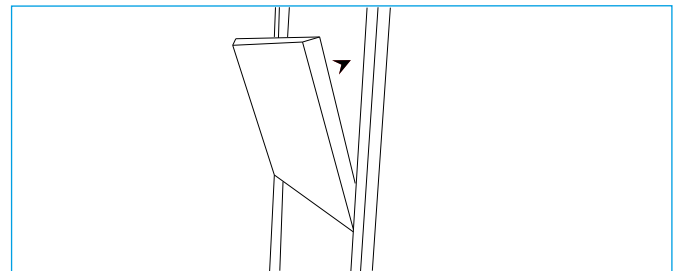

INSULATION

- Place mineral wool (stone wool 30-40 kg/m³ or glass wool 20-25 kg/m³) between the furring.

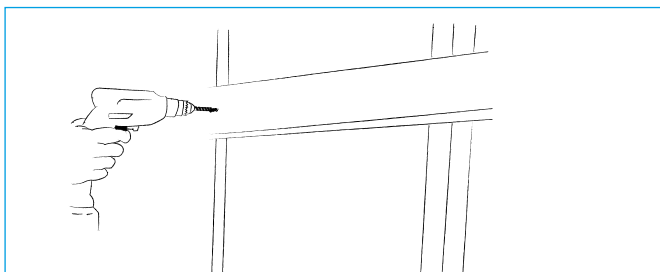

INSTALLATION OF HORIZONTAL FURRING

- Use special fire protective furring.
- Screw fix 20 x 120 mm fire protective furring horizontally at 600 mm intervals (the furring must be placed precisely in relation to the joint between the panels).
- Up to 1800 mm above the floor fix additional horizontal fire protective furring 20 x 50 mm midway between the main horizontal furring (the furring must be placed in relation the centre of the panel).

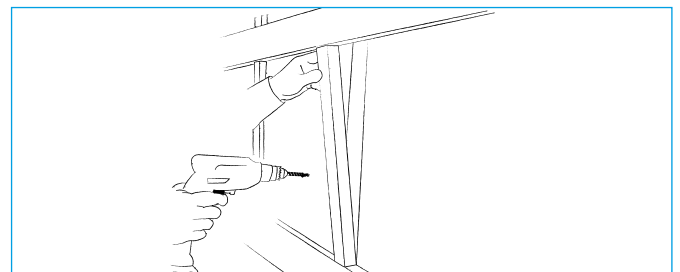

INSTALLATION OF VERTICAL FURRING

- Fix vertical fire protective furring 20 x 120 mm directly on top of the primary vertical wooden furring, between the horizontal furring.
- It is important that the furring is installed in this way to make a plane support framework for the Kinopanel.

INSTALLATION GUIDE

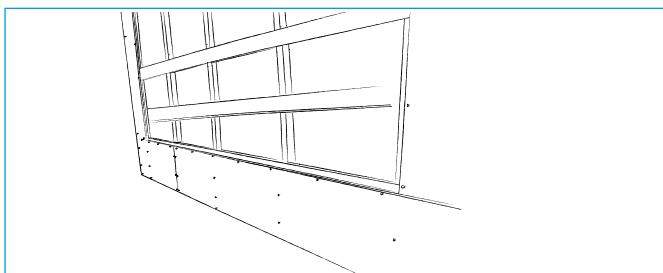

INSTALLATION OF FRIEZE

- If a frieze is to be installed, it is important that the frieze opening is at right angles and made precisely in relation to the number of Kinopanel to be installed.
- The frieze should be installed, filled and painted prior to installation of the Kinopanel.

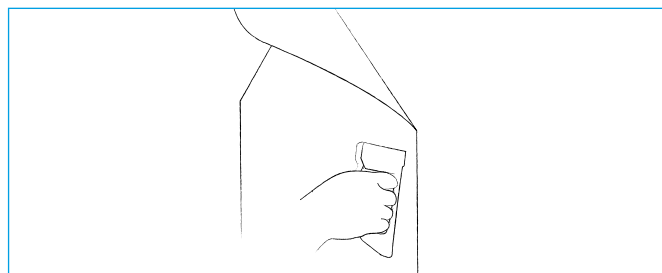

FIXING OF KINO FELT

- Staple the Kino felt to the furring in the area where the Kinopanel are to be installed.

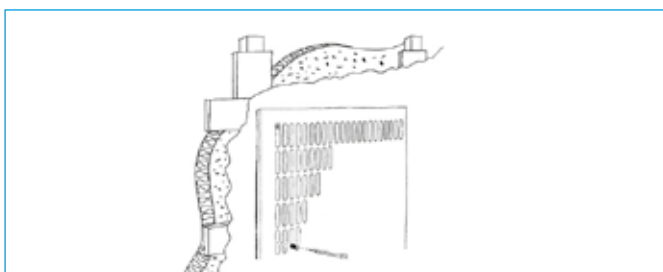

INSTALLATION OF PANELS

- Kinopanel is fixed on all four sides at 300 mm distances (i.e. 8 screws per 600 x 600 mm panel)
- Mount acoustic rubber plugs in the perforation slots of the panel and screw through the plugs with Knauf Danoline screw SN3.5x30, so that the Kinopanel is securely fixed to the framework.

DETAILS

KINOPANEL ON FURRING

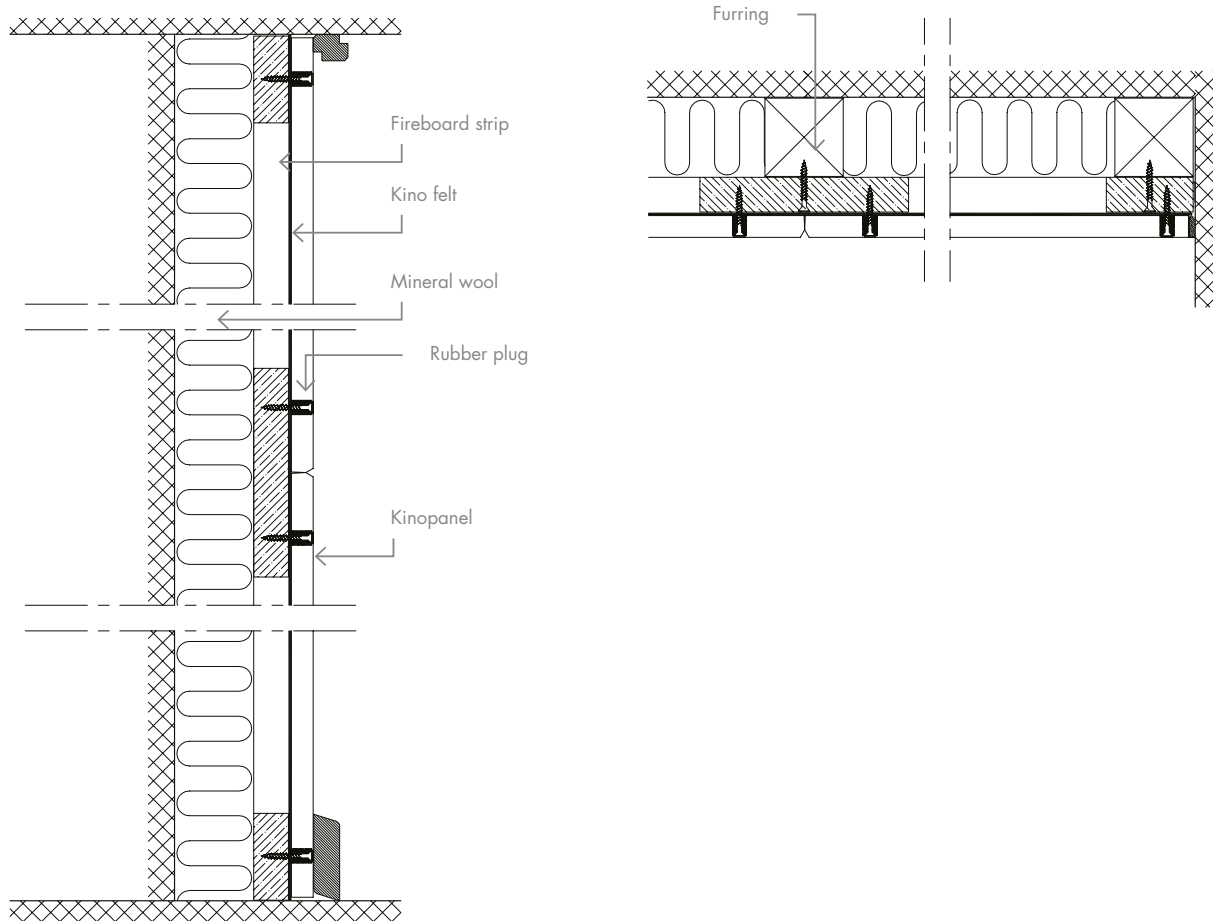

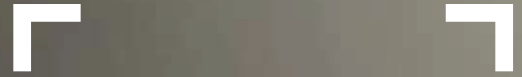

DID YOU KNOW THAT ...

Knauf Danoline products are tested for indoor air quality according to Danish Indoor Climate Labelling; and that they are placed in best category with low particle emission and an indoor value of 10 days?

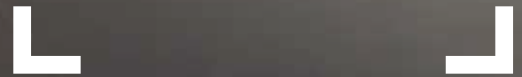

AMFIPANEL

ACOUSTIC WALL PANELS

Special acoustic wall lining for cinemas and other entertainment premises. Discreet unified look with elegant oval perforations. Good sound diffusive properties preventing echoes and ensuring acoustic comfort.

ACOUSTIC WALL PANELS

AMFIPANEL

SIZES

600 x 600 x 12.5 mm

600 x 900 x 12.5 mm

SURFACE

Standard black painted NCS S-9000-N (gloss 5)

Other colours available on request.

DANISH INDOOR CLIMATE LABELLING (DIM)

Indoor value: 10 days

Particle emission: low (< 0.75 mg)

CLEANING

Dust is removed using a dry duster or vacuum cleaner. Marks can be removed with a damp cloth using normal cleaning practices and neutral cleaning solutions.

AMBIENT CONDITIONS

The product is designed to perform under normal conditions of use. Tested at 70% RH and 25°C. The product can withstand ambient temperatures of up to 50°C.

LIGHT REFLECTION

5.5%

FIRE CLASS

A2-s1,d0

FIRE RATING

Class 1; K₁ 10, A2-s1,d0

ROBUSTNESS

Made of robust, glass fibre reinforced material with excellent pressure resistance. Under normal conditions of use, the product properties are preserved and there is no decomposition of material over time.

WEIGHT

Indicative tile weight: 7.20 kg/m².

CERTIFICATES

- Declaration of Conformity (EN 14190)
- Danish Indoor Climate Labelling

ACOUSTIC WALL PANELS AMFIPANEL

ACOUSTICS

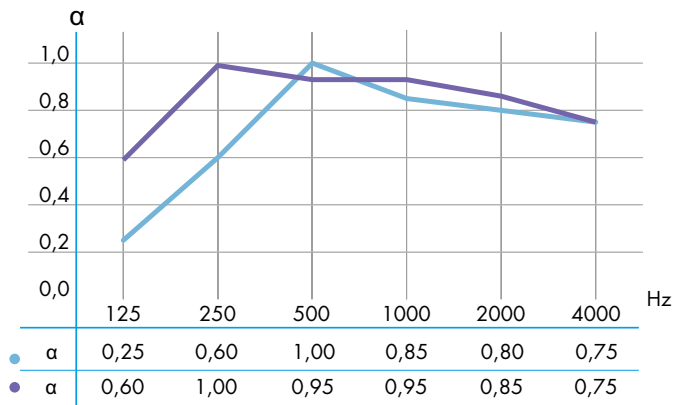

- Tangent, 85 mm installation depth, 50 mm mineral wool aw: 0.85, NRC: 0.80
- Tangent, 135 mm installation depth, 100 mm mineral wool aw: 0.90, NRC: 0.95

For acoustic data on alternative constructions please see "Absorption Data" at knaufdanoline.com

EDGES

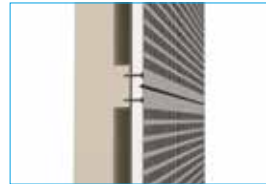

Edge B
(Bevelled edge)
Visible joints

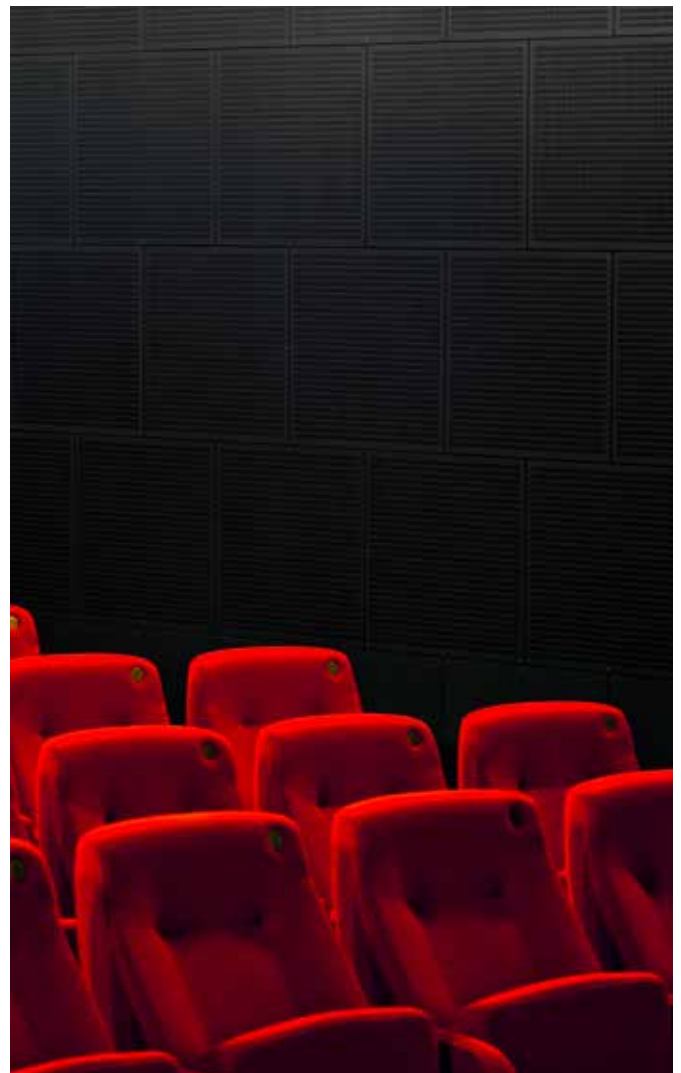

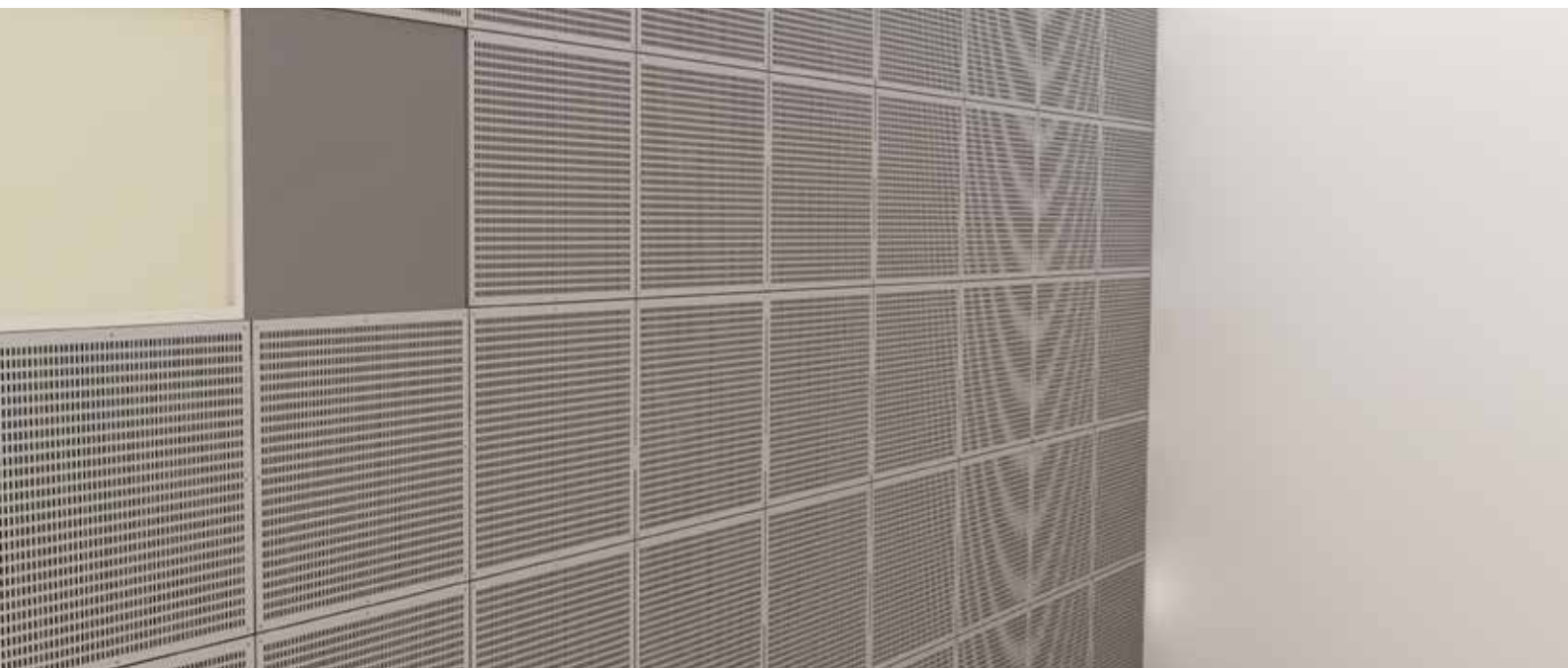

PERFORATION

Also available as Regula.



Tangent, 4 x 14 mm,
10/20 mm c/c
Perforation: 22.9%

INSTALLATION GUIDE

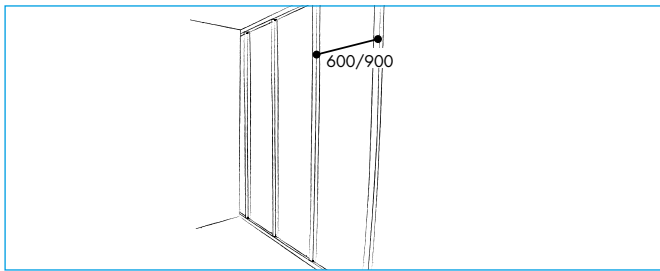
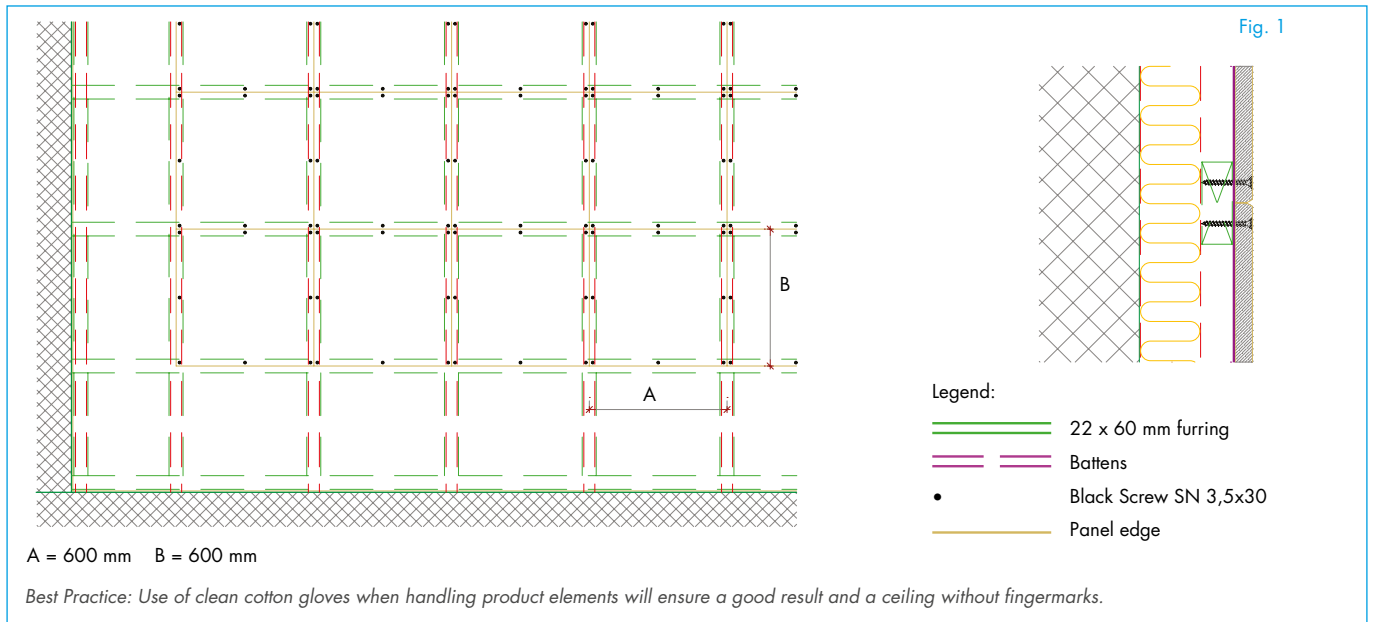

FURRING

- Fix 50x50 mm or 50x100 mm battens vertically at 600 mm (Amfipanel 600) or 900 mm (Amfipanel 900) intervals.
- The battens must be placed vertically precisely in relation to the joint of the panels.

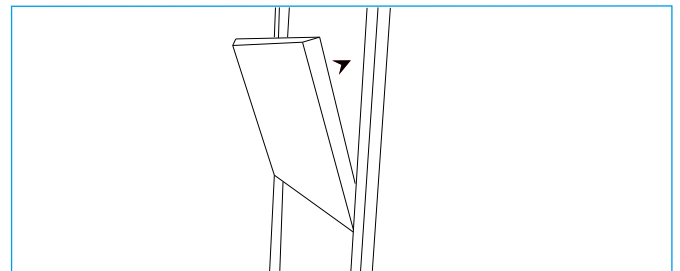

INSULATION

- Place mineral wool (stone wool 30-40 kg/m³ or glass wool 20-25 kg/m³) between the battens.

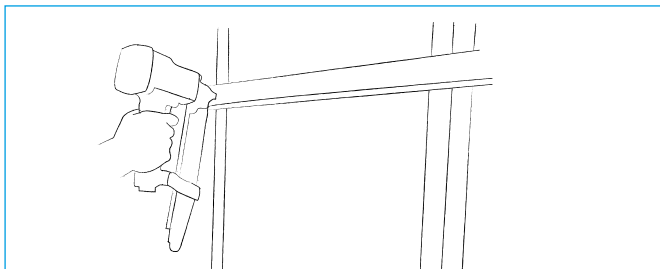

INSTALLATION OF HORIZONTAL FURRING

- Fix 22x60 mm planed battens horizontally to the furring at 600 mm c/c.
- It is important that the battens are mounted precisely and perpendicularly.

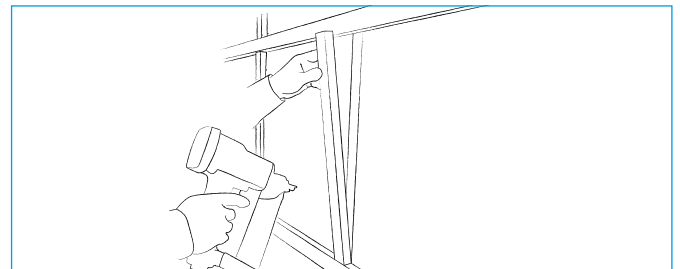

INSTALLATION OF VERTICAL FURRING

- Fix 22x60 mm planed battens on top of the primary furring at 600 mm c/c (Amfipanel 600) or 900 mm c/c (Amfipanel 900).
- It is important that the vertical battens are perpendicular to and flush with the horizontal battens, so that the furring structure is completely plane.

INSTALLATION GUIDE

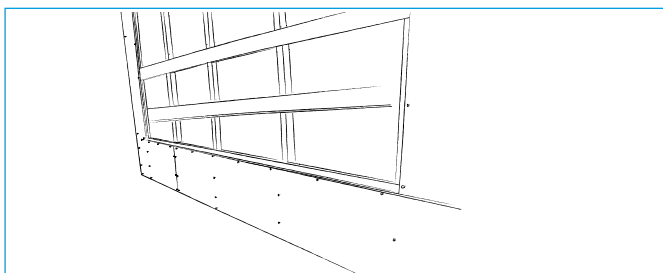

INSTALLATION OF POSSIBLE FRIEZE

- If a frieze is to be installed, it is important that the opening between the friezes is perpendicular and precisely adjusted to the quantity of Amfipanel.
- Install and paint the frieze before installing the panels.

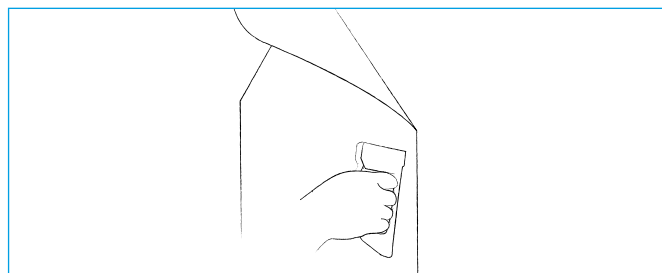

FIXING OF FELT

- Secure the Kino felt to the furring in the area where Amfipanel is to be mounted.

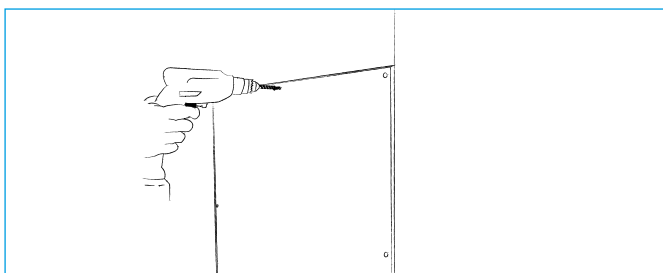

INSTALLATION OF PANELS

- Fix the Amfipanel to the furring through the pre-drilled holes.
- Use black screws (min. 30 mm).

DETAILS

AMFIPANEL ON FURRING

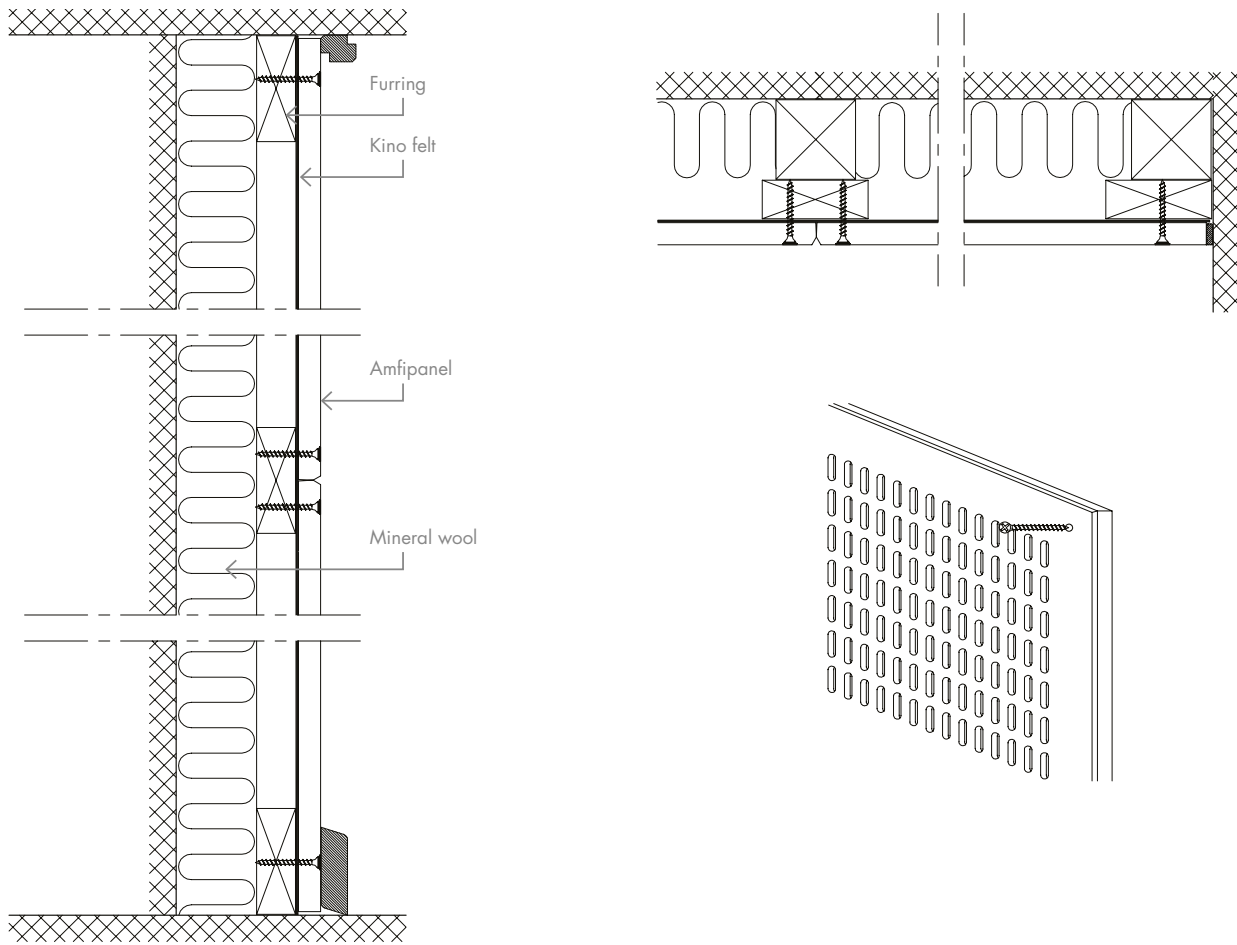

ACCESSORIES

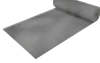
PRODUCT NAME		SAP NO.	W x L x H
SN 3.5x30		3503	3.5 x 30
Kino felt		592361	1.26 x 100 m

DID YOU KNOW THAT ...

Adit is available with print
of your own choice, and will
instantly pick up the look of the
room and create a comfortable
sound environment?

ADIT

ACOUSTIC WALL PANELS

Highly effective acoustic post-adjustment in existing rooms. Exceptionally fast and easy installation. Minimum disturbance of the daily activities in the room. Easy cleaning and maintenance thanks to the foil-covered, robust surface.



ACOUSTIC WALL PANELS

ADIT

SIZES

450 x 2400 x 9.5 mm

450 x 1200 x 9.5 mm

SURFACE

Foil-covered with pre-impregnated white paper NCS S0300-N (RAL 9016, gloss 10)

Foil tested for chemical resistance in accordance with DIN 68 861, FIRA BS 3962 and NEMA LD-3-1991

DANISH INDOOR CLIMATE LABELLING (DIM)

Indoor value: 10 days

Particle emission: low (< 0.75 mg)

CLEANING

Dust is removed using a dry duster or vacuum cleaner. Marks can be removed with a damp cloth using normal cleaning practices and neutral cleaning solutions.

AMBIENT CONDITIONS

The product is designed to perform under normal conditions of use. Tested at 90% RH and 30°C. The product can withstand ambient temperatures of up to 50°C.

FIRE CLASS

B-s1, d0

ROBUSTNESS

Durable and dirt resistant surface. Product made of robust, glass fibre reinforced material with excellent pressure resistance. Under normal conditions of use, the product properties are preserved.

WEIGHT

Indicative weight: 8.0 kg/2400 mm board.

Indicative weight: 4.0 kg/1200 mm board.



CERTIFICATES

- Declaration of Conformity (EN 14190)
- Danish Indoor Climate Labelling

ACOUSTIC WALL PANELS

ADIT

ACOUSTICS

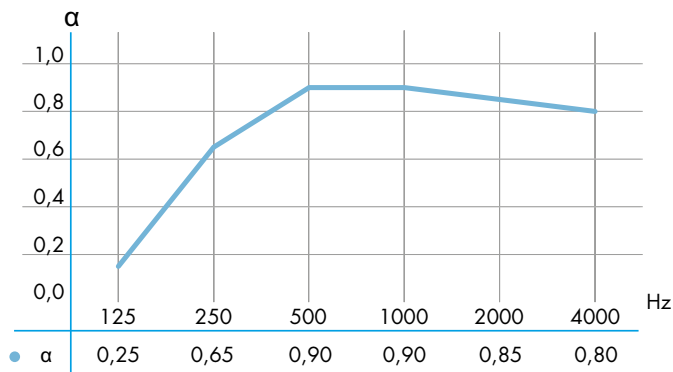

• Tangent, 55 mm installation depth, 33 mm mineral wool α_w : 0.90, NRC: 0.85

EDGES

**Edge B**

(bevelled edge)

Mitred and glued long edges

REVERBERATION TIME

Measurement before and after Adit

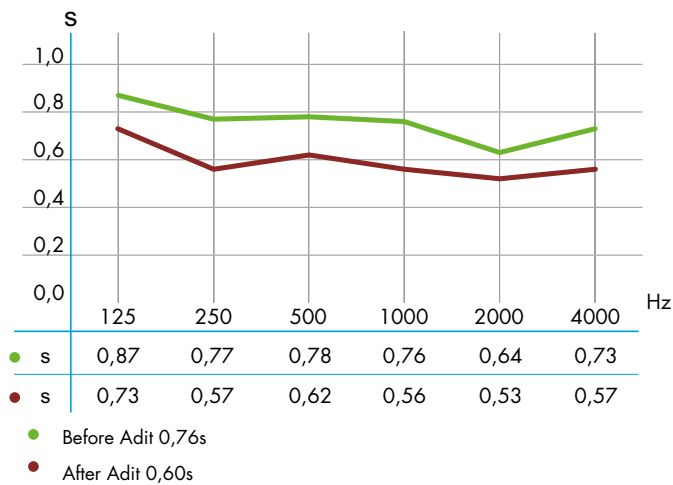

For acoustic data on alternative constructions please see "Absorption Data" at knaufdanoline.com



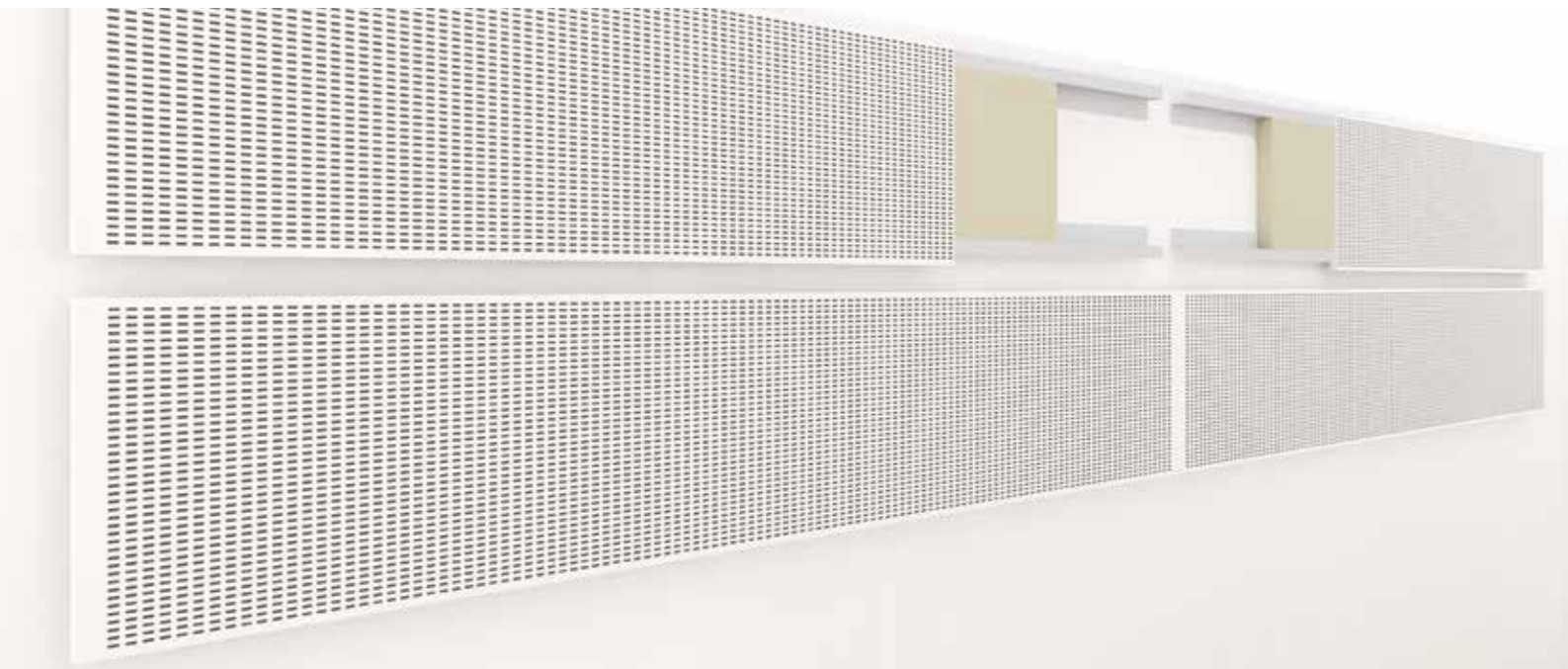

PERFORATION



Tangent 4x14 mm,
10/20 mm c/c
Perforation 2400 mm: 24.5%
Perforation 1200 mm: 23.9%

INSTALLATION GUIDE

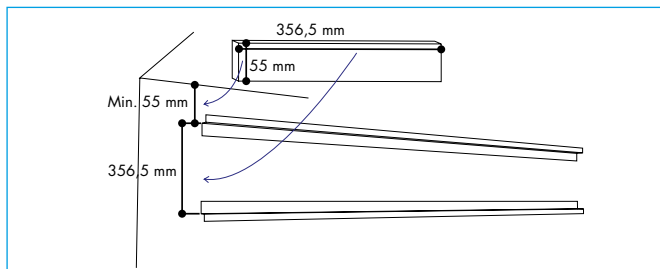
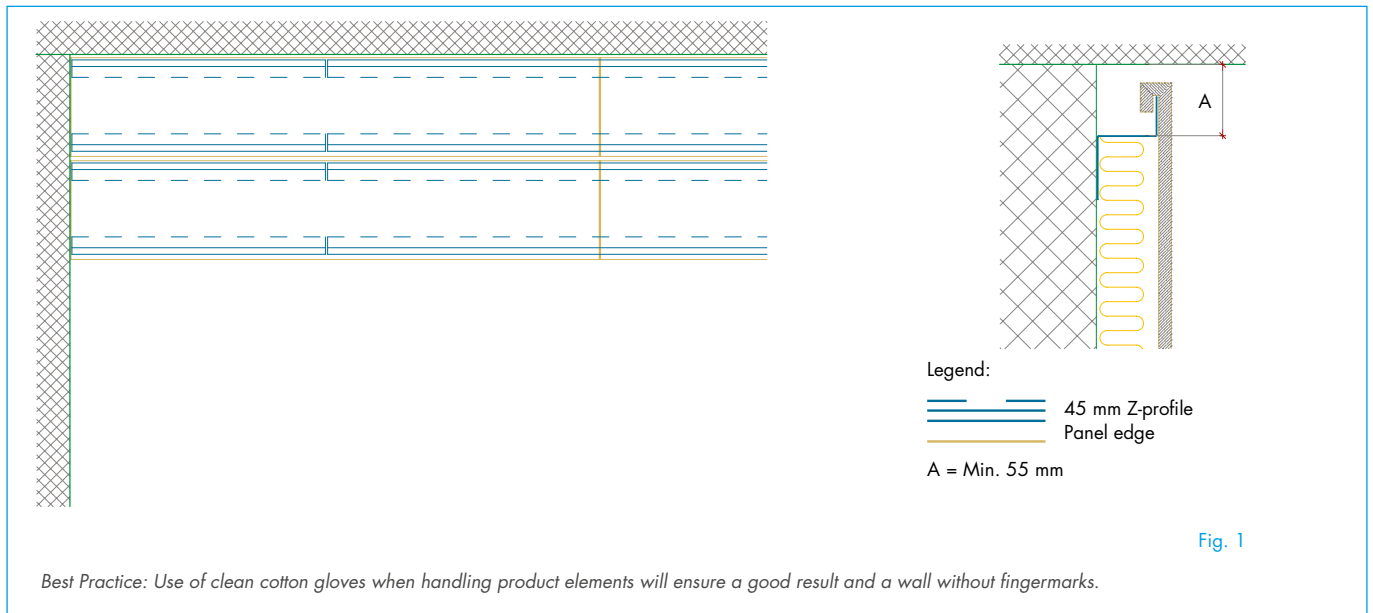

MEASURING

- Use the gypsum template supplied to mark the positions of the Z profiles.

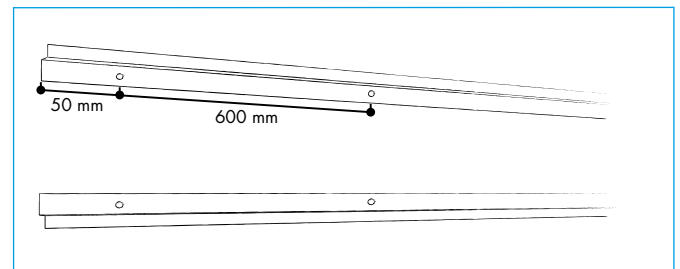

Z-PROFILES

- Install the Z profiles horizontally. Choose the method of securing the angles in accordance with the substrate.
- The large flange on the Z profiles must be secured to the wall.
- When installing several Adit elements in continuation of each other it will be an advantage to stagger the joints of the uppermost Z profiles by half a length in relation to the joints of the elements in order to ensure that the elements are level.

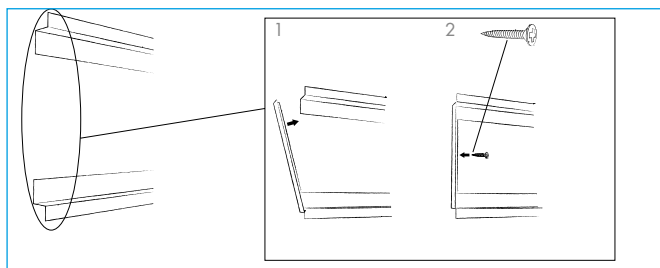

END COVER

- Where elements do not run from wall to wall, use the end covers supplied to cover the mineral wool at the visible ends. Push the end cover behind the Z profiles and secure with a screw through the pre-bored hole.

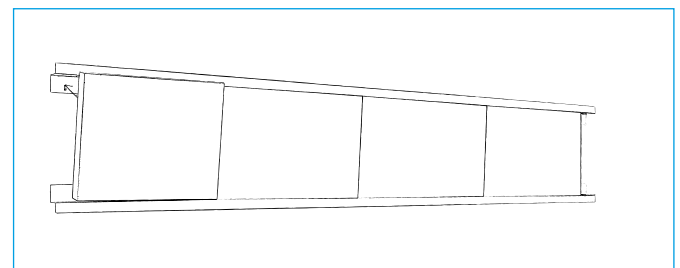

DANOPOR

- Install the plastic-wrapped mineral wool between the Z profiles.

INSTALLATION GUIDE

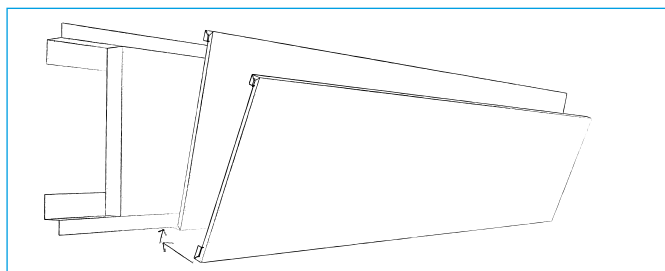

INSTALLATION OF ADIT PANELS

- Push the edge of the Adit panel with the largest fold under the lower profile and press it upwards.

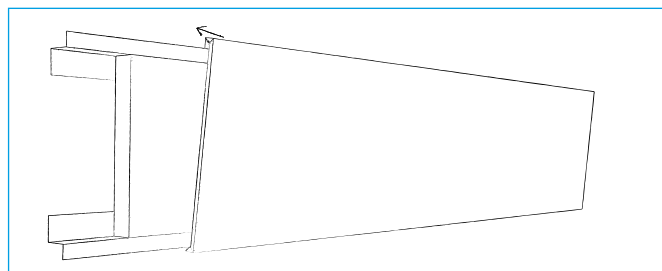

INSTALLATION

- Tilt the Adit element over the top profile.

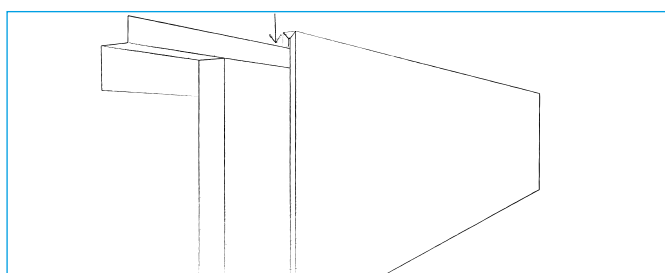

INSTALLATION

- Lower the element over the top profile.
- The element is now in position but can still be adjusted longitudinally.
- Elements should be butted up to one another/the adjacent wall. Where the elements stop in the middle of the wall, fit the supplied end covers and profiles as illustrated below.

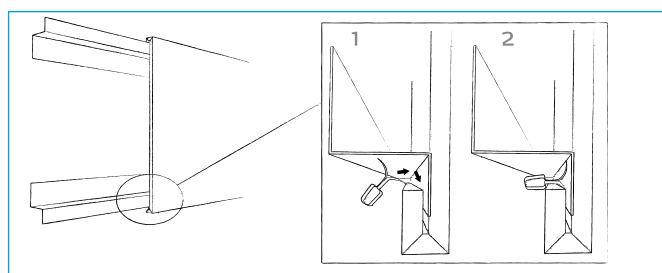

SECURING

- Lock the element in position at the bottom with the help of the hold down clips supplied.

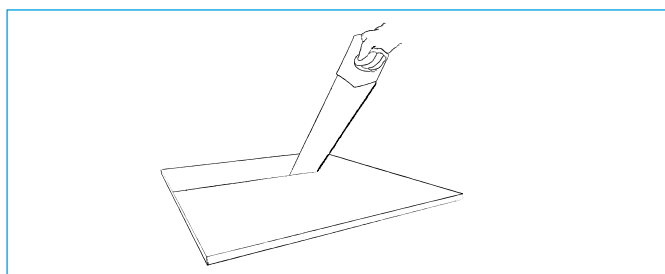

CUTTING

- Cut the elements to size from the front with a fine-toothed saw.

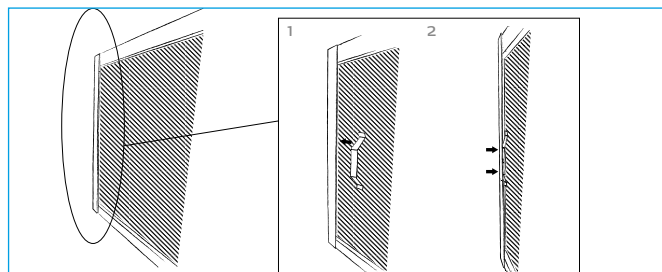
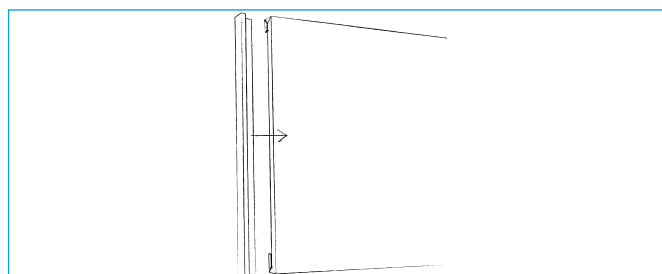

END PROFILE

- Where end covers are installed the associated Adit elements should be capped with an end profile.
- Push the end profile over the end of the element.
- The smallest flange must cover the front of the element.
- Lock the end profile in place using the end profile clip.





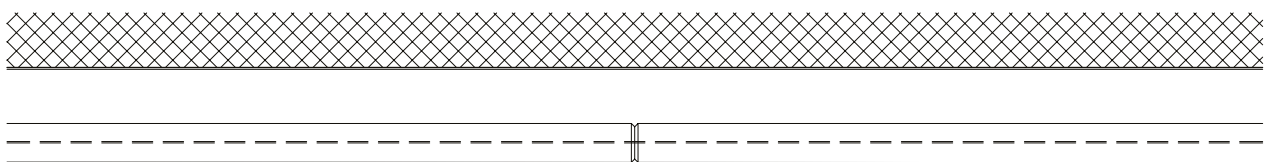
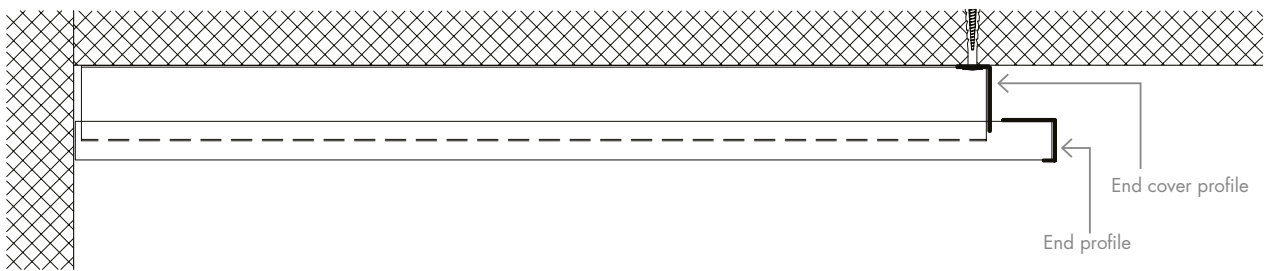
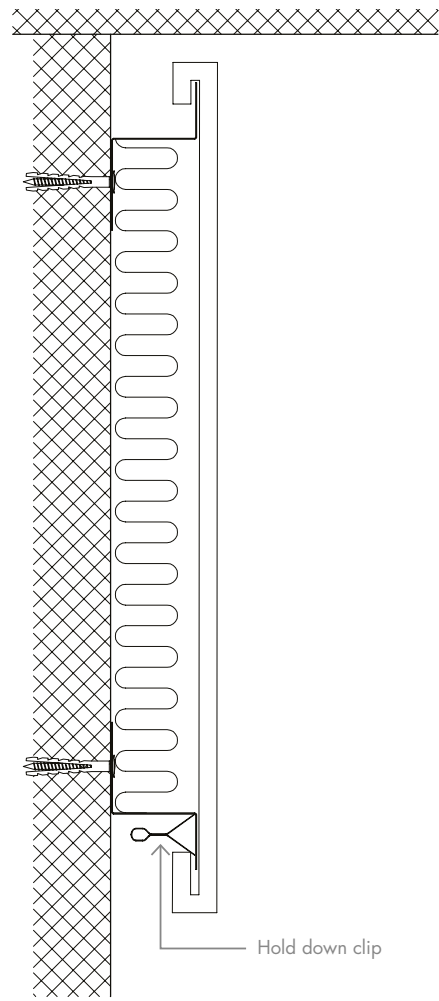
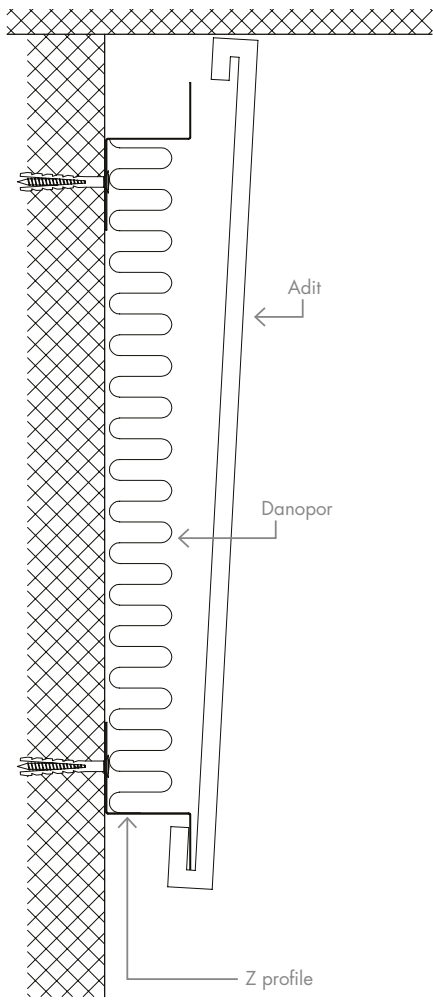

Check also our
installation video

DETAILS



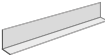



ADIT



ACCESSORIES 2400 MM

PRODUCT NAME		SAP NO.	W x L x H
Z45 profile		199089	45 x 2300
End cover profile		215384	20 x 360 x 40
Wall channel		199108	25 x 32/7.5 x 450
Danopor		199062	33 x 350 x 575
Measuring template		657259	55 x 356.5
Hold down clip		316313	-
End profile clip		108961	-

ACCESSORIES 1200 MM

PRODUCT NAME		SAP NO.	W x L x H
Z45 profile		656969	45 x 1100
End cover profile		215384	20 x 360 x 40
Wall channel		199108	25 x 32/7.5 x 450
Danopor		656695	33 x 350 x 550
Measuring template		657259	55 x 356.5
Hold down clip		316313	-
End profile clip		108961	-



DID YOU KNOW THAT ...

Knauf Danoline is part of the worldwide Knauf Group - one of the most important suppliers of construction materials in the world?



MITEX

ACOUSTICAL SHAPES

Countless possibilities to create your own shapes. Precise, knife-sharp edging.
Opportunity to play with gypsum like playing with paper.

ACOUSTICAL SHAPES

MITEX

SURFACE

Standard untreated

DANISH INDOOR CLIMATE LABELLING (DIM)

Indoor value: 10 days

Particle emission: low (< 0.75 mg)

CLEANING

Dust is removed using a dry duster or vacuum cleaner. Removal of marks depends on the paint used on site, although a damp cloth using normal cleaning practices and neutral cleaning solutions is normally suitable for minor marks. In the case of stubborn marks or if in doubt refer to the paint manufacturer's recommendations.

AMBIENT CONDITIONS

The product is designed to perform under normal conditions of use. Tested at 70% RH and 25°C. The product can withstand ambient temperatures of up to 50°C.

FIRE CLASS

A2-s1,d0

FIRE RATING

Class 1; K₁ 10, A2-s1,d0

ROBUSTNESS

Made of robust, glass fibre reinforced material with excellent pressure resistance. Under normal conditions of use, the product properties are preserved and there is no decomposition of material over time.



ACOUSTICAL SHAPES

MITEX

SIZES

- Thickness: 9 or 13 mm
- Max. width of board: 1200 mm
- Max. width from edge to furthest cut: 950 mm
- Max. length of board: 3000 mm
- Min. length from edge to the first cut: 15 mm
- Min. length of board: 200 mm and min. 1/3 of the board's width

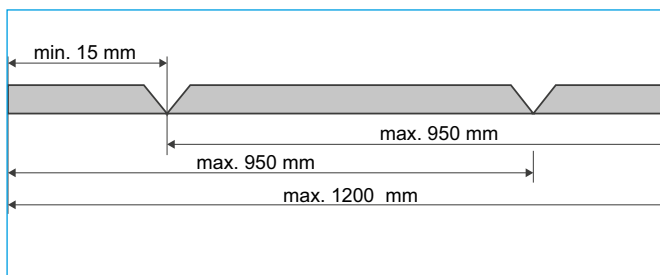

INSTALLATION

Glue the elements to shape by applying silicate glue to the V-cuts immediately before installation of Mitex.

The support must be level. Maximum distance between the supports depends on the shape and the application of the Mitex element. The Mitex elements are screw-fixed directly through the panel.





PERFORATION

Supplied non-perforated
 Customised perforation design on request.

ANGLES

Min. angle 30°
 Max. angle 135°

Angles from 30° up to 90° and from 90° to 135° upon request. Please contact our sales department for further details.
 For all angles below or above 90° a drawing must accompany the order.

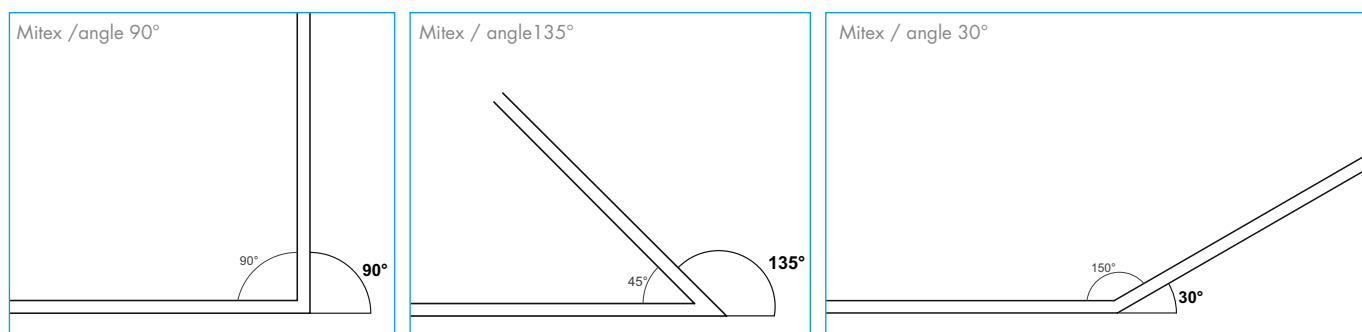

ACCESSORIES

PRODUCT NAME	SAP NO.	W x L x H (mm)
Aquapanel® Indoor Joint Adhesive	103389	310 ml





DID YOU KNOW THAT...

in nature, when limestone and smoke particles from volcanos come in contact with water, the crystal $\text{Ca SO}_4 + \text{H}_2\text{O}$ is produced? The Beerenberg volcano on Jan Meyen is the reason for large quantities of natural gypsum, around the world.



CURVEX

ACOUSTICAL SHAPES

Arches bounded only by the limits of the imagination.
Organic design with different edges adaptable to all types
of ceiling and wall designs.

ACOUSTICAL SHAPES

CURVEX

SURFACE

Standard untreated

DANISH INDOOR CLIMATE LABELLING (DIM)

Indoor value: 10 days

Particle emission: low (< 0.75 mg)

CLEANING

Dust is removed using a dry duster or vacuum cleaner. Removal of marks depends on the paint used on site, although a damp cloth using normal cleaning practices and neutral cleaning solution is normally suitable for minor marks. In the case of stubborn marks or if in doubt refer to the paint manufacturer's recommendations.

AMBIENT CONDITIONS

The product is designed to perform under normal conditions of use. Tested at 70 % RH and 25° C. The product can withstand ambient temperatures of up to 50° C.

FIRE CLASS

A2-s1,d0

ROBUSTNESS

Made of robust, glass fibre reinforced material with excellent pressure resistance. Under normal conditions of use, the product properties are preserved and there is no decomposition of material over time.

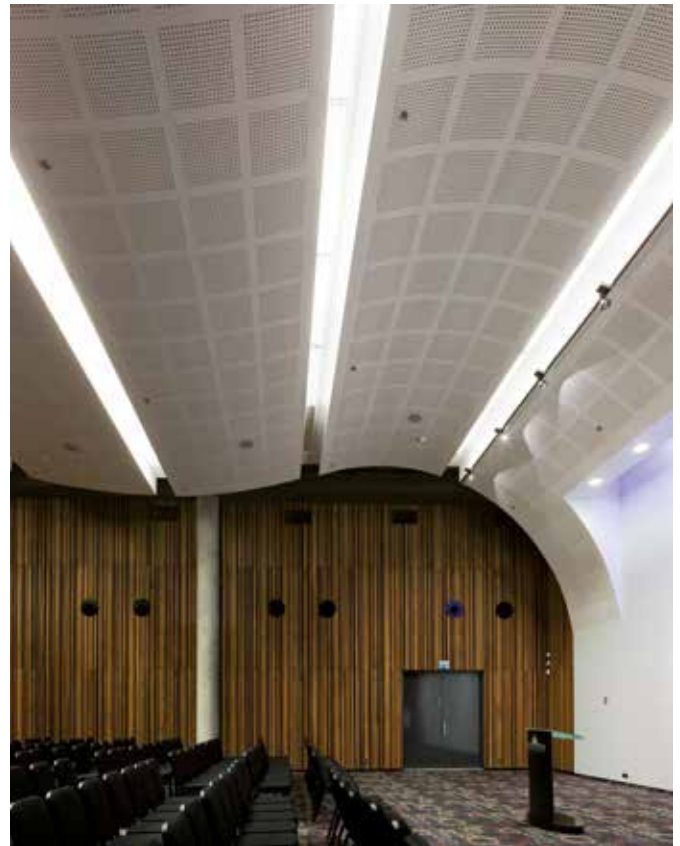

ACOUSTICAL SHAPES CURVEX

SIZES

- Min. radius: 25 mm
- Min. length: 200 mm
- Max. length: 3000 (type A)
- Min. thickness 2 x 6 mm
- Circle cut: 0° - 180°

Radii under 80 mm (internally) are groove cut.
Radii under 120 mm (internally) must be filled completely.

EDGES

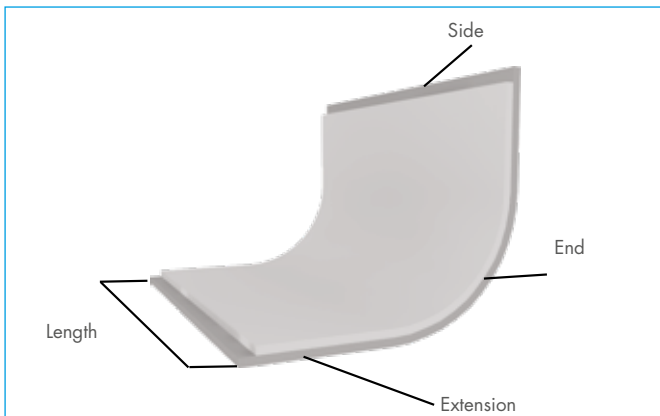

Extensions are optional and are used for joint filling. For optimal result, we recommend extensions if the Curvex elements are to be connected with regular gypsum boards.

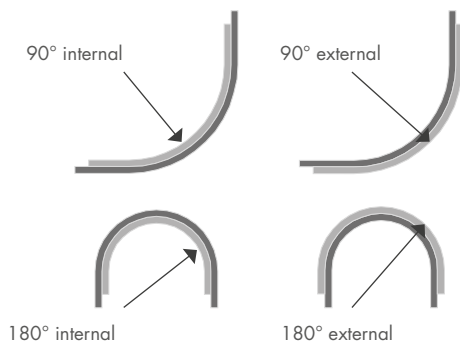

The column cladding is supplied in 4 nos. 180° shells, each consisting of 2x6 mm gypsum boards:

- 2 shells for 1st layer
- 2 shells for 2nd layer

The second layer to be installed 90° staggered.

S-shaped curves are produced to customer specification. Drawing must be supplied. Please contact Knauf Danoline for more information.

INSTALLATION

Curvex elements must be mounted on a stable support. Secure the elements to the support at a max. screw distance of 300 mm in both directions. Both ends of the curve must be secured.

As a general rule, the Curvex elements are screw fixed through the board. If the Curvex elements with bevelled edges are used, push the elements close together.

If the elements on the other hand require joint filling, leave a space of 2-4 mm between the elements. Bevel off square edges and prime them with Knauf primer.



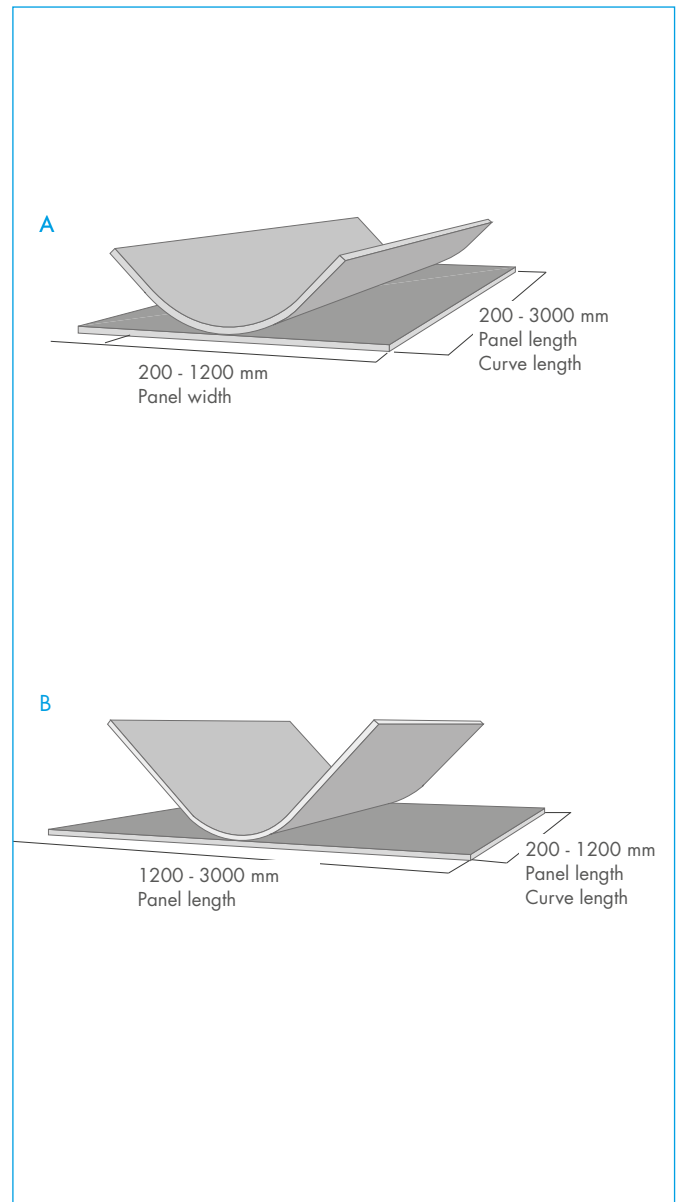

Knauf Danoline recommends Knauf Uniflott filler for joint filling.





PERFORATION

Supplied non-perforated.
 For perforated curved panels, please see Designpanel and Tectopanel

EDGE		END	SIDE
	Square edge	E1	S1
	Square edge 25 mm staggered	E2	S2
	Square edge 50 mm staggered	E4	
	Bevelled edge	E7	
	Bevelled edge 50 mm staggered	E8	

Curve length (mm)	A			B		
	1200 - 3000			≤ 1200		
	90°	180°		90°	180°	
Thickness (mm)	13	18	25	13	18	25
50 - 100	■	■	■			
101 - 200	■	■	■			
201 - 300	■	■	■			
301 - 400					■	■
401 - 500	■	■	■		■	■
501 - 600					■	■
601 - 700				■	■	■
701 - 800				■	■	■
801 - 900				■	■	■
901 - 1000				■	■	
1001 - 1100				■	■	
1101 - 1200				■	■	
1201 - 1300				■	■	
1301 - 1400				■	■	

This size **can** be produced
 This size *cannot* be produced

PERFORATIONS

The different perforations ensure acoustical performance of and give identity to Knauf Danoline products. Each perforation has its own characteristics from the organic look of round holes, to grid-like look of the micro square holes, to the maritime look of large square holes or the technical look of large oval holes.

UNITY

Complete series of most essential acoustic ceiling designs - see the two next pages

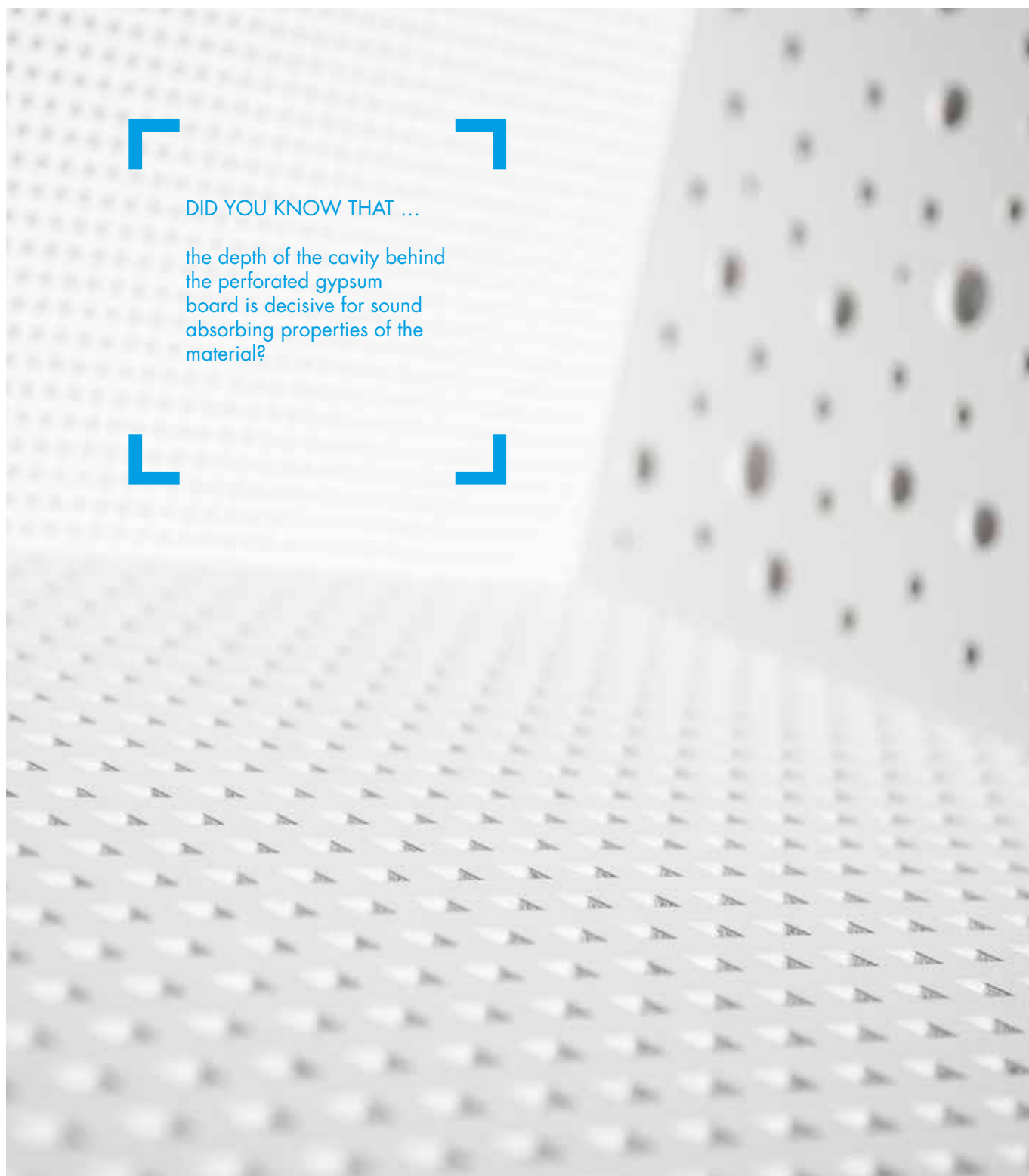

PERFORATIONS UNITY 3

Unity 3's square, pixel-like perforation gives it a hi-tech appearance. Unity 3 (U3) perforation patterns consist of 3.5 x 3.5 mm square perforations that run to the edge of the tile and create a monolithic ceiling surface. The distance to the edge of the tile is 8.3 mm.

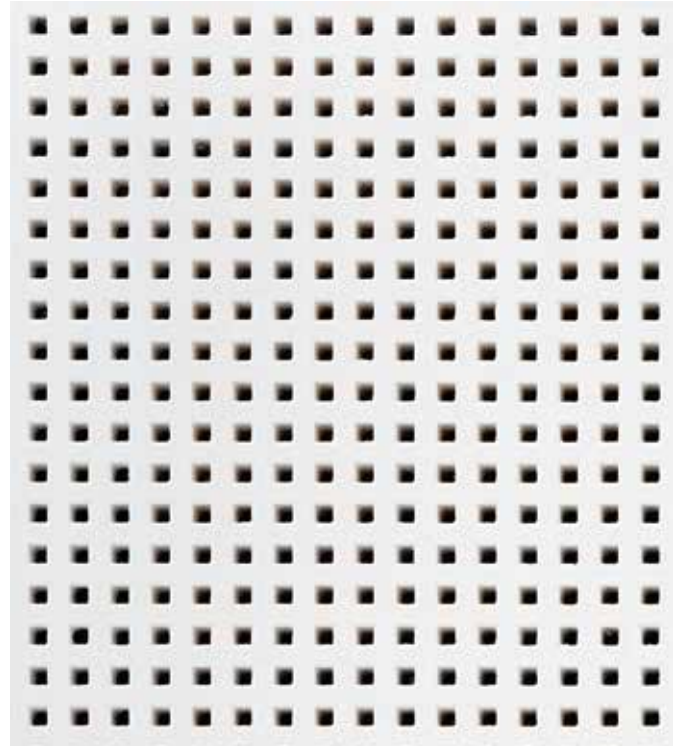
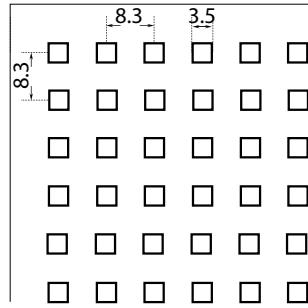

UNITY 3	PERFORATION PERCENTAGE	DISTANCE TO EDGE
PRODUCTS		
Contur	17.2%	8.3 mm
Belgravia	17.2%	8.7 mm (S15)
		8.3 mm (S24)
Plaza	17.2%	8.7 mm (S15)
		8.3 mm (S24)

PERFORATIONS UNITY 4

Unity 4 (U4) perforation patterns consist of 4 mm circular holes at 10 mm c/c and 10 mm to the edge of the tile that create a monolithic ceiling surface.

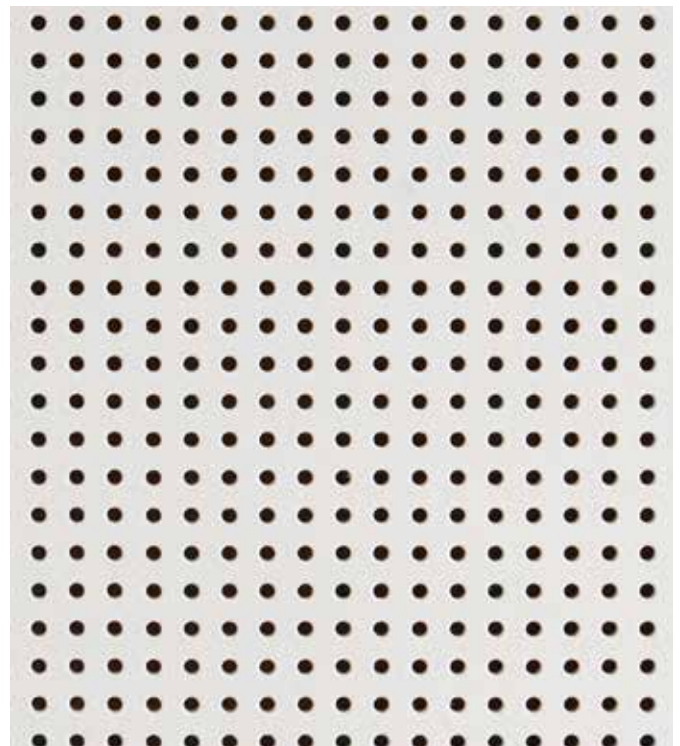
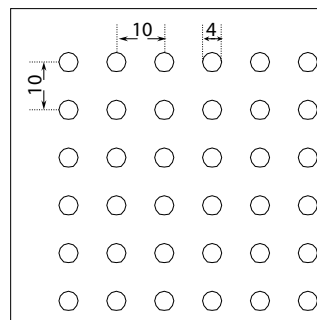

UNITY 4	PERFORATION PERCENTAGE	DISTANCE TO EDGE
PRODUCTS		
Contur	12.2%	10 mm
Belgravia	12.2%	12 mm (S15)
		12.5 mm (S24)
Plaza	12.2%	12 mm (S15)
		12.5 mm (S24)

PERFORATIONS

UNITY 8 | 15 | 20

Unity 8 | 15 | 20 has round randomly distributed perforations with three different diameters: Ø8 mm, Ø15 mm and Ø20 mm.

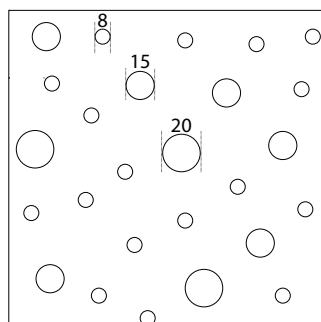

UNITY 8 15 20	PERFORATION PERCENTAGE
PRODUCTS	
Contur	10.8%
Belgravia	10.8%
Plaza	10.8%

PERFORATIONS

UNITY 9

Unity 9 (U9) perforation patterns consist of 9.0 x 9.0 mm square perforations at 20 mm c/c which create a maritime expression to the ceiling.

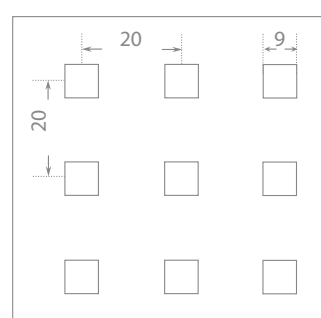

NEW PERFORATION

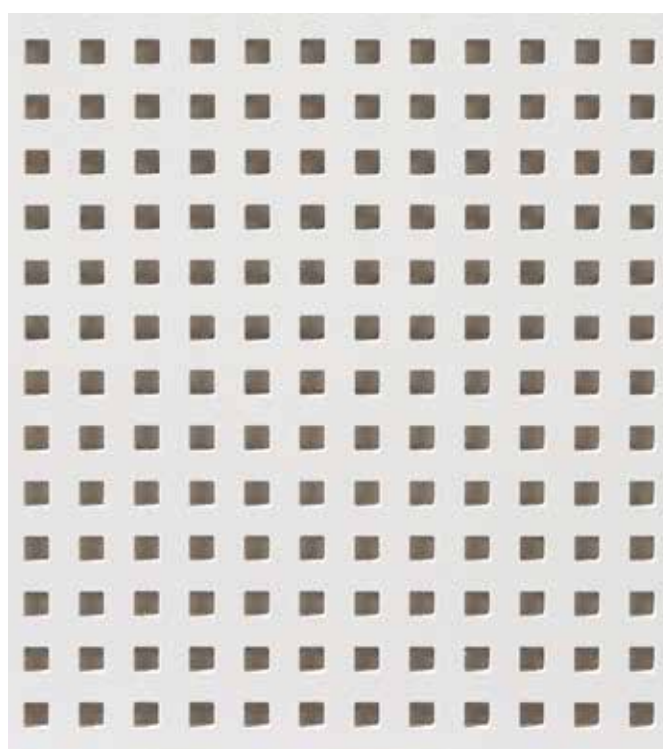

UNITY 9	PERFORATION PERCENTAGE	DISTANCE TO EDGE
PRODUCTS		
Belgravia	18.9%	12 mm (S15)
Plaza	18.9%	12 mm (S15) 17.5 mm (S24)
Contur	18.9%	17.5 mm (S24)

PERFORATIONS MICRO

Micro perforation patterns consist of 3 x 3 mm square holes at 8.3 mm c/c.

MICRO	PERFORATION PERCENTAGE	A	B	C	D	
PRODUCTS						
Contur	10.2%	37.5	510	37.5	510	
Belgravia S24	10.2%	29.5	525	29.5	525	
Markant S24	10.2%	25.25	525	25.25	525	
Plaza	10.2%	34.5	525	34.5	525	
Corridor	10.6%	37.5	325	25	1150/1750/2350	
Corridor Swing	9.9%	41.9	491.7	41.9	1091.7	
Tectopanel	10.2%	37.5	525	37.5	525	
Danopanel	10.2%	37.5	525	45	510	
	PERFORATION PERCENTAGE	A	B	C	D	E
Designpanel M1F	9.8%	62.5	775	62.5	775	125
Designpanel M2F/900	7.1%	62.5	325	62.5	325	125
Designpanel M2F/1200	8.4%	62.5	475	62.5	475	125

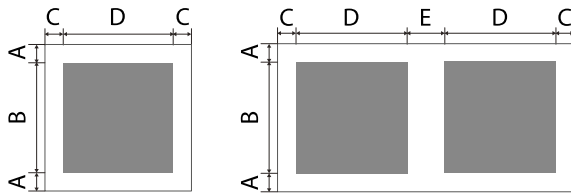
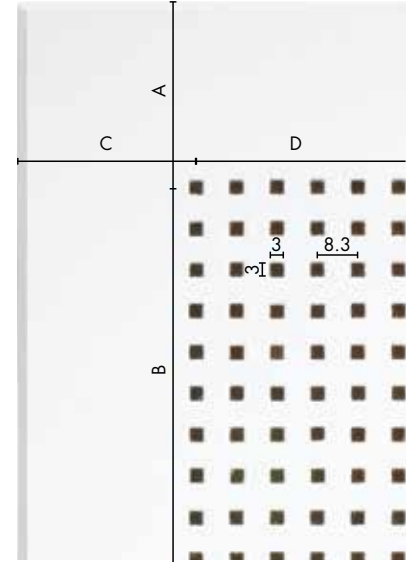

PERFORATIONS QUADRIL

Quadril perforation patterns consist of 12 x 12 mm square holes at 30 mm c/c.

QUADRIL	PERFORATION PERCENTAGE	A	B	C	D	
PRODUCTS						
Contur	13%	45	510	45	510	
Belgravia S24	13%	37	510	37	510	
Markant S24	13%	32.75	510	32.75	510	
Plaza	13%	42	510	42	510	
Corridor	14.2%	35	330	30	1140/1740/2340	
Corridor Swing	11.5%	62.75	450	62.75	1050	
	PERFORATION PERCENTAGE	A	B	C	D	E
Designpanel Q1F	13%	60	780	60	780	120
Designpanel Q2F/900	10.2%	60	330	60	330	120
Designpanel Q2F/1200	11.6%	60	480	60	480	120

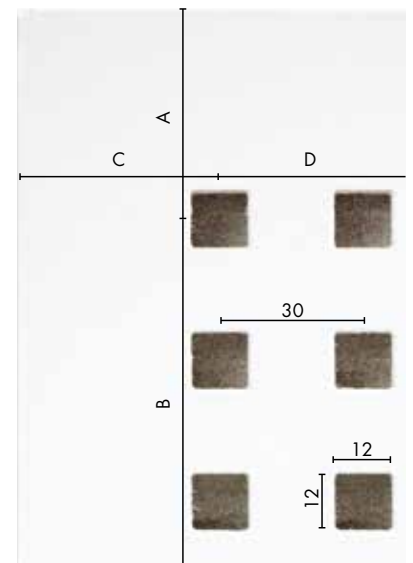

A / C: Distance between the edge of the tile and the centre of the 1st perforation row.

B / D: Size of the perforation field from the centre of the 1st perforation row to the centre of the last perforation row.

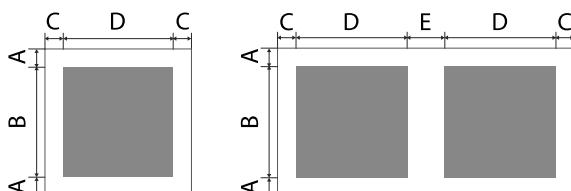

PERFORATIONS TANGENT

Tangent perforation patterns consist of 4 x 14 mm oval holes at 10/20 mm c/c.

TANGENT	PERFORATION PERCENTAGE	A	B	C	D
PRODUCTS					
Visona	21.3%	22.5	330	40	1120
Belgravia S24	21.3%	27	530	32	520
Plaza	21.3%	32	530	37	520
Corridor	21.6%	35	330	30	1140/1740/2340
Tectopanel	21.3%	35	530	40	520
Amfipanel	22.9%	25	550	30	540
Adit	24.5%	15	420	40	2320
Designpanel - T3L1, T3L2, T3L4 - see page 98					

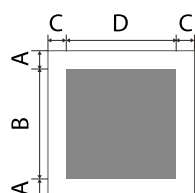

A / C: Distance between the edge of the tile and the centre of the 1st perforation row.

B / D: Size of the perforation field from the centre of the 1st perforation row to the centre of the last perforation row.

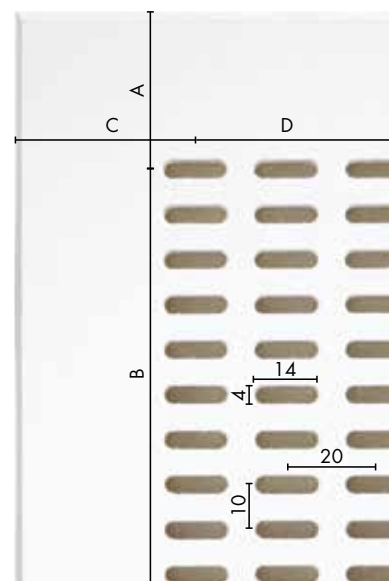

PERFORATIONS GLOBE

Globe perforation patterns consist of 6 mm circular holes at 15 mm c/c.

GLOBE	PERFORATION PERCENTAGE	A	B	C	D	
PRODUCTS						
Contur	10.2%	37.5	525	37.5	525	
Belgravia S24	10.2%	29.5	525	29.5	525	
Markant S24	10.2%	25.25	525	25.25	525	
Plaza	10.2%	34.5	525	34.5	525	
Corridor	10.6%	35	330	30	1140/1740/2340	
Corridor Swing	10%	40.25	495	40.25	1095	
Tectopanel	10.2%	37.5	525	37.5	525	
Danopanel	10.2%	37.5	525	37.5	525	
	PERFORATION PERCENTAGE	A	B	C	D	E
Contrapanel	10.2%	37,5	525	37,5	525	75
Designpanel G1F	9.8%	60	780	60	780	120
Designpanel G2F/900	8.6%	60	330	60	330	120
Designpanel G2F/1200	8.6%	60	480	60	480	120

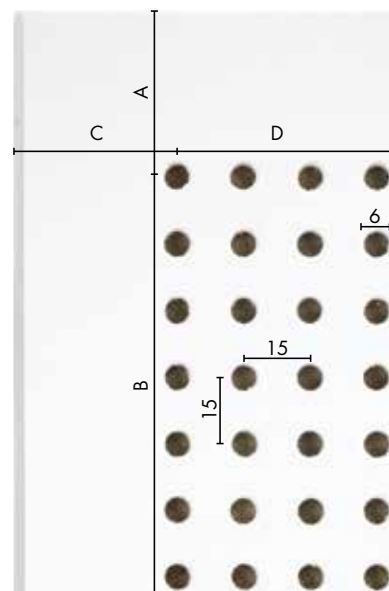
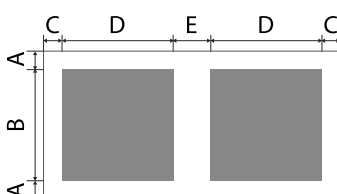
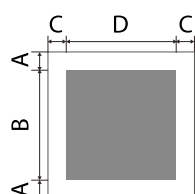

PERFORATIONS STRATO

STRATO perforation comes in two different perforation designs with a random sequence of round holes in three different sizes, viz.

- 8/15/20 mm and
- 12/20/35 mm.

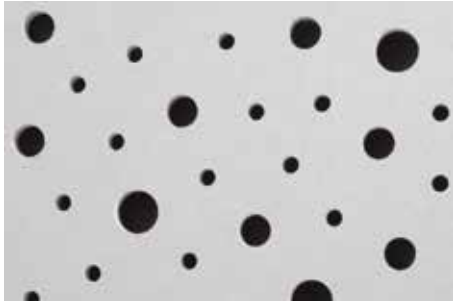

G8/15/20

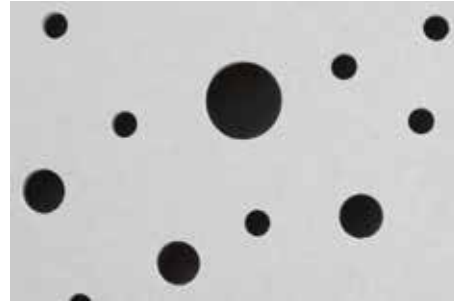

G12/20/35

PERFORATIONS SOLO

SOLO perforation comes in nine different perforations designs in a fixed, uniform sequence:

- 6, 8, 10, 12 and 15 mm round holes in uniform sequence
- 8 and 12 mm square holes in uniform sequence
- 8/12 mm and 12/20 mm staggered round holes in uniform sequence

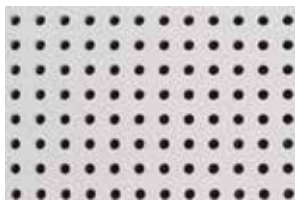

G6/18

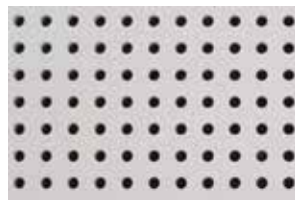

G8/18

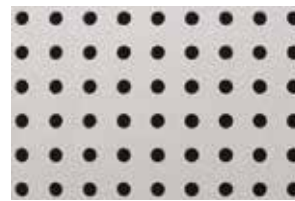

G10/23

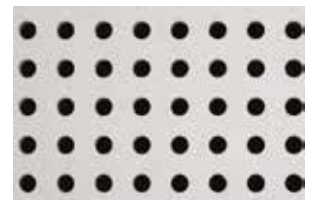

G12/25

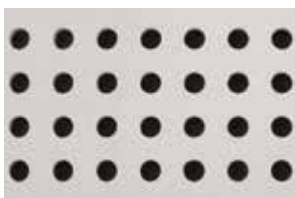

G15/30

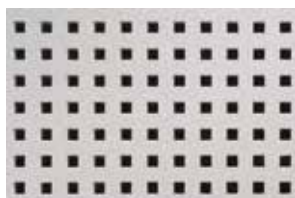

Q8/18



Q12/25

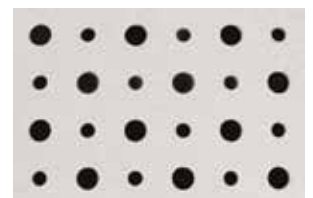

G8/12/50

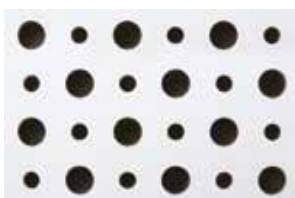

G12/20/66

PERFORATIONS

KINO

Kino perforation consists of 8 x 53 mm oval holes at 15 / 60 mm c/c. Kino perforation is especially designed to diffuse sound in cinemas and other entertainment premises.

KINO	PERFORATION PERCENTAGE	A	B	C	D
PRODUCT					
Kino	36.9%	60	480	37.5	525

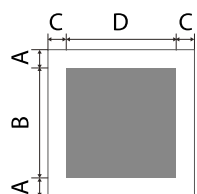

A / C: Distance between the edge of the tile and the centre of the 1st perforation row.

B / D: Size of the perforation field from the centre of the 1st perforation row to the centre of the last perforation row.

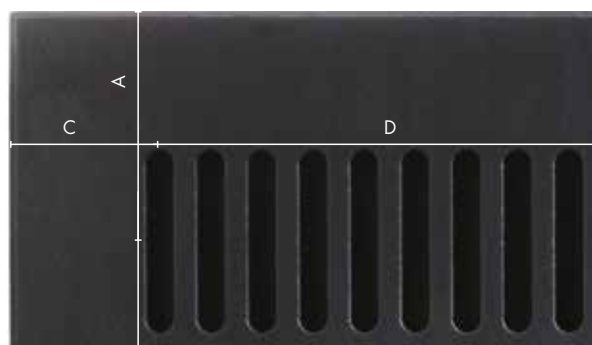



DID YOU KNOW THAT ...

the diffusion of perforated gypsum boards is beneficial to speech intelligibility in a room?

PROPERTIES

Knauf Danoline products create indoor comfort for the occupants of the building by providing excellent acoustic environment, high air quality, pleasant light reflection and classic, timeless aesthetics. They are environmentally responsible and sustainable materials that can last the lifetime of the building.

PROPERTIES

ACOUSTICS

With Knauf Danoline acoustic materials it is possible to create acoustic solutions that always meet your national acoustic requirements for specific reverberation time.

Depending on the construction of the ceiling and the perforation design, certain Knauf Danoline products can absorb up to 90% of the sound that hit the ceiling surface.

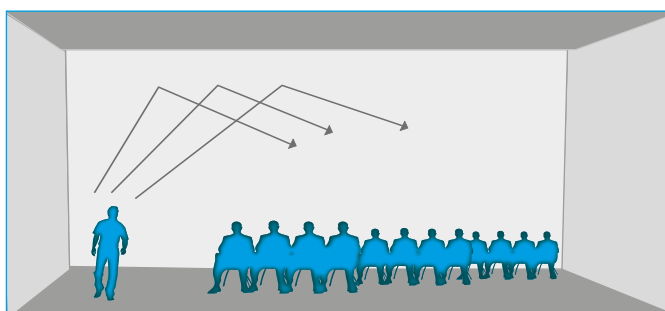
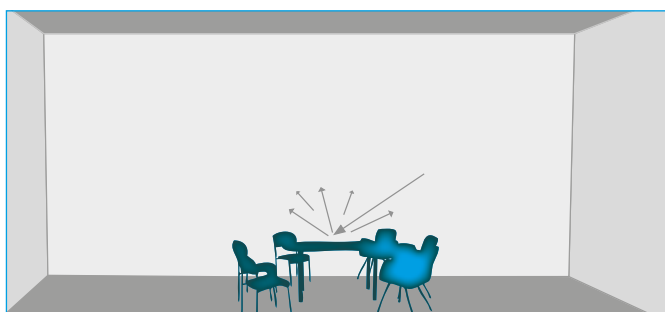
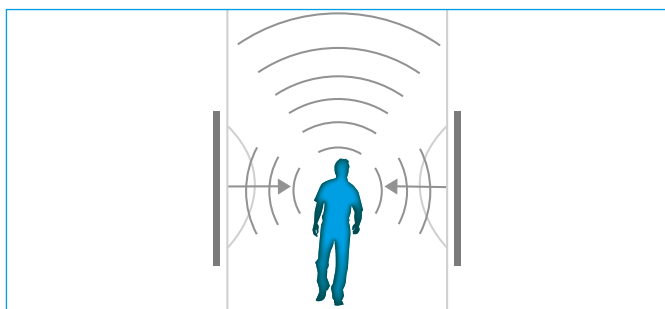

When calculating the amount of Knauf Danoline's acoustic materials necessary to meet a given reverberation time, it is important to consider:

- the total ceiling construction which the acoustic materials will be part of;
- the shape of the room and placement of acoustic materials
- the amount of furniture entering into the finished room
- the purpose of the room

The acoustic materials combined with the system on which they are installed form the acoustic construction that absorbs sound. Thus, the amount of sound absorbed depends on the installation depth of the ceiling and whether or not the cavity is filled with mineral wool.

The shape of the room defines the movement of the sound waves within the room. Placement of acoustic materials should be determined by the way the sound moves in that particular room in order to ensure optimal efficiency of the materials.

Furniture represents acoustic materials in itself. In order to avoid too much sound absorption, which can cause acoustic discomfort just like too little absorption, it is important to take into account the amount of furnishings.

The purpose of the room is decisive for the acoustic environment to be created. In rooms for speech, such as classrooms and auditoriums, it is important to ensure a good level of sound spreading, whereas rooms for concentrated work require a high level of absorption.



Did you know that Knauf Danoline products can be repainted time after time without any loss of their acoustic properties?

PROPERTIES

AIR QUALITY

The hardening of gypsum boards used for the manufacturing of Knauf Danoline products is based purely on reactions with water, and contains therefore no volatile liquids or suchlike. Thus, the use of Knauf Danoline products causes no health nuisances.

All surface finishes used on Knauf Danoline products (i.e. high and low gloss paint and different foils) are also classified as non-hazardous and for reasons of indoor climate safety and consideration for the environment, there are no added biocides that give an active biocidal effect within or on the finished surface film.

Danish Indoor Climate Labelling is a voluntary labelling scheme, the first one in the world to rate construction materials according to their indoor climate properties during the service phase.

The rating covers degassing with a time value in days, and particle emission, based on the release of particles from sedimentable dust.

Knauf Danoline products have the following classifications:

- Indoor climate value: 10 days
- Particle emission: LOW (< 0.75 mg)

Knauf Danoline products are additionally rated according to the Swedish Sunda Hus labelling - an overall assessment of the product's environmental and health impacts, from its origin to its disposal:

- Untreated and painted products: Class A†
- Foil-finished products: Class B†

Knauf Danoline products are recommended by the Swedish Byggarubedömningen, an association gathering the largest property companies and investors in Sweden with the view of establishing a common standard for building materials by assessing the chemical contents, the life cycle criteria and the possible effects on indoor climate of a building material.



PROPERTIES

CLEANING

All Knauf Danoline products tolerate normal cleaning practices and neutral cleaning solutions. Dust can be removed by a dry duster or a vacuum cleaner. Removal of marks can be carried out with a damp cloth.

Danotile - hygiene ceiling - is able to withstand tough cleaning and disinfection agents with pH from 2 to 13.

Danotile is clean-room certified and can be used in rooms requiring high infection control such as laboratories, kitchens, slaughterhouses, etc.

Danotile achieves silver classification in Excell, and is classified as ISO 5 in accordance with ISO 14644-1.



PROPERTIES

LIGHT REFLECTION

The paint on Knauf Danoline products has a low gloss value which ensures good light spreading - a property which is sustained over time. For the finished Knauf Danoline products, the light reflectance values are influenced by the product's perforation design, the colour and gloss value of the factory paint. For untreated products, the light reflectance values are determined by the paint applied on site.

Light reflection requirements depends on the activity in the room. For offices with direct lighting the recommendation is approximately 70%.

PERFORATION	PAINT COLOUR	GLOSS	GLOSS ON SUBSTRATE	REFLECTANCE
Tangent T1	Standard white	5	2	70.9 %
Micro M1	Standard white	5	2	72.1 %
Quadril Q1	Standard white	5	2	75.1 %
Globe G1	Standard white	5	2	72.8 %
Regula R plain	Standard white	5	2	82.6 %
Unity U3	Standard white	5	2	69.2%
Unity U4	Standard white	5	2	72.5%
Unity U8 15 20	Standard white	5	2	72.2%
Unity U9	Standard white	5	2	71.6%
Regula R plain	Standard white	15	10	80.8%
Regula R plain	White foil laminated	10	White foil	86.3 %



PROPERTIES

LOAD-BEARING CAPACITY

The breaking load test in accordance with EN 14190 ensures that the products can bear 5 times their own weight. This means e.g. a non-perforated Belgravia tile is tested with a load of up to 17 kg without any damage to the tile. The purpose of the test is to secure the stability of the ceiling.

Knauf Danoline's products adhere to the EN 13964 standard for deflection, which consists of the classifications listed below.

The individual product's load-bearing capacity in relation to fittings (for instance lamps), varies from product to product and can therefore be found on page 236 and 237 of this catalogue.

CLASS CONDITIONS

CLASS	CONDITIONS
A	Building structures exposed to a max. RH of 70% and a maximum temperature of 25°C
B	Building structures exposed to a max. RH of 90% and a maximum temperature of 30°C

DEFLECTION CLASSES

CLASS	MAX. DEFLECTION in mm
1	L/500 and not more than 4 mm
2	L/300
3	No limitations

L is the shortest distance between the supporting profiles. For a 600 module the maximum deflection for class 1 is 1.2 mm and 2 mm for class 2

PROPERTIES

AMBIENT CONDITIONS

Knauf Danoline products are tested for resistance to moisture in service. Products tested for resistance up to 70% RH at 25°C are designed for use under normal living and working conditions, i.e. in offices, institutions and similar premises.

Products tested for resistance up to 90% RH at 30°C are designed for use under more extreme conditions and can thus

be used in high humidity rooms and rooms with frequent and major changes in the humidity of the air.

However, at lower relative humidity gypsum is able to tolerate much higher temperatures. Gypsum can therefore also be used in buildings where temperatures can fluctuate up to 50°C for shorter periods of time.



PROPERTIES

ROBUSTNESS

Knauf Danoline products are made of robust material with excellent pressure resistance. Under normal conditions of use, the product properties are preserved, and there is no decomposition over time.

Foil-covered products have a highly durable and dirt resistant surface.

Contrapanel - impact resistant acoustical ceiling and wall panel - is specially designed to meet the strictest requirements for ceiling and wall linings in intensively used facilities such as sport halls and gymnasiums. Contrapanel meets the class 3 requirements in accordance with EN 13964 for impact resistant ceiling linings, and DIN 18032 for impact resistant wall linings, making the product suitable for handball and hockey courts where materials are required to absorb sound as well as withstand heavy impacts.



PROPERTIES

ENVIRONMENT

Knauf Danoline acoustic ceiling and wall materials are manufactured from high grade gypsum boards, supplied from our company, Knauf A/S. The gypsum boards are made from following gypsum types:

- naturally occurring gypsum, found in large quantities in the ground
- gypsum produced from by-products at local power plants during desulphurisation – a chemical process in which the sulphur dioxide is removed using limestone powder mixed with water to form the by-product gypsum
- preconsumer recycled gypsum, waste produced through our own production processes
- postconsumer recycled gypsum, is plasterboard waste that is received from gypsum recycling companies. Companies gathering and recycling gypsum waste from building sites across Denmark.

Both Knauf Danoline and Knauf A/S are ISO certified companies with constant focus on environmental management and optimisation of the production processes to the benefit of the local surroundings, our customers and the environment in general. Knauf Danoline products are distinguishable by their unique features:

- natural material
- long lifetime and service time
- re-use and recycling
- environmentally responsible production
- high quality service life

In order to ensure the possibility that used Knauf Danoline products can be recycled, they are painted with water-based paint, which not only allows recycling but also has no deteriorating effect on the humidity regulating properties of the gypsum material.

Another essential prerequisite for the recycling of gypsum board is to keep the gypsum core free from harmful additives. The main binding agent in the core is in fact water.

The acoustic felt on the back of Knauf Danoline's perforated gypsum boards is made of cellulose which makes it unnecessary to remove the felt before the recycling of gypsum board. In fact, the dissolved cellulose felt gives increased flexibility to the gypsum board.

The cardboard used in our plasterboard products is produced from 100% recycled sources. The cardboard and paper foils are also separated out from the core gypsum material at the recycling plant, so that a greater proportion of gypsum board waste is able to be recycled. The cardboard fraction is used as a structure material in the formation of compost at KomTek Environment A/S in Denmark.



ENVIRONMENTAL POLICY

Based on the life cycle approach, we wish to contribute to ensuring sustainable development in the long term. We therefore work continuously on improving the environmental conditions and to prevent pollution by:

- using environmentally responsible raw materials in the manufacturing of our products
- using packaging that can be recycled or utilised
- optimising the consumption of energy, raw materials and packaging
- reducing the waste
- utilising the waste

Knauf Danoline is committed to reducing waste and energy consumption. Therefore, investments are made each year in energy and waste efficiency.

The guiding principle for the manufacturing of Knauf Danoline products is to keep the basic material as pure as possible in order to secure continuous recycling.

CERTIFICATES

ISO ACCREDITATIONS & OTHER APPLICABLE CERTIFICATES:

- ISO 9001- Quality management
- ISO 14001- Environmental management
- OHSAS 18001 - Occupational Health & Safety
- LES FICHES DE DÉCLARATION ENVIRONNEMENTALES ET SANITAIRES (FDES) - French Environmental & Health and Safety declaration based on Life Cycle Analysis
- LEED DECLARATION

PROPERTIES

FIRE SAFETY

Knauf Danoline ceiling and wall products meet all the necessary fire safety requirements:

Material classes according to EN 13501-1

- A2-s1,d0
White painted ceiling tiles
Untreated lining panels
- B-s1,d0
Foil laminated ceiling tiles

Material classes according to ASTM E84

- Class A
White painted ceiling tiles, perforated and non-perforated
Untreated perforated and non-perforated lining panels
Foil laminated ceiling tiles

Fire resistance according to BS 476-23:1987

- ½ hour fire resistance
Danotile 6.5 mm – foil finished, non-perforated

Fire resistance according to EN 13501-2 and DS 1052-1 1985

- EI 30 (BD-30)

Fire protection according to EN 13501-2 and EN 14135 2004 & DS 1065-2 1990

- K1 10 and K2 10
Untreated perforated lining panels



PROPERTIES

HYGIENE

Hygiene is a key consideration in many buildings. That's why Knauf Danoline painted acoustic ceilings and wall linings are coated with a low polymer, high density paint that has a very low attraction to dust particles. This prevents dust and other particles infiltrating the microscopic gaps in the surface structure. The durability of the coating also means that tougher stains can be removed using standard cleaning practices and neutral cleaning solutions.

To minimise the risk of mould growth and bacteria, Knauf Danoline products are manufactured with built-in anti-mould and anti-bacteria agents. These are effective even in areas that are prone to continuous high temperatures, high air humidity or aggressive gases. Furthermore, all products are tested for anti-microbial growth resistance according to DIN EN 1104 (Determination of the migration of anti-microbial substances) Grade 3.

For more robust cleaning regimes and rooms that require high infection control, our foil-covered, clean-room certified Danotile can withstand tough cleaning and disinfection agents with pH values ranging from 2.5 to 13. This includes peracetic acid and H₂O₂ commonly used in hospitals, where even after 120 cleaning cycles, Danotile remains ISO 5 compliant. Danotile can also withstand air pressure variations of up to +/- 30 Pa.

Nearly all materials face challenges in environments that can be severely affected by aggressive bacteria, such as hospitals and laboratories. To meet this challenge, we have developed a

unique paint surface called Medifend that can be applied to our standard products. Medifend has a very powerful fungistatic effect and is tested in accordance with DIN ISO 846, Method B and B'. When optimal hygienic conditions are required, Medifend is the ideal solution.

In addition to being aesthetically strong and structurally innovative, Knauf Danoline products are also easy to mount and de-mount, allowing easy access to the void for essential service and maintenance tasks.



PROPERTIES COLOURS

Knauf Danoline products are delivered as standard untreated, white painted or white laminated.

Knauf Danoline also deliver products painted in NCS and RAL colours. Products are typically dipped and spray finished, although very light colours can be spray finished alone.

Maximum panel size for dipping is 600x1200 mm.

Products are finished with a water based acrylic paint in gloss 5. Due to the nature of the substrate the finish appears as a gloss 2.

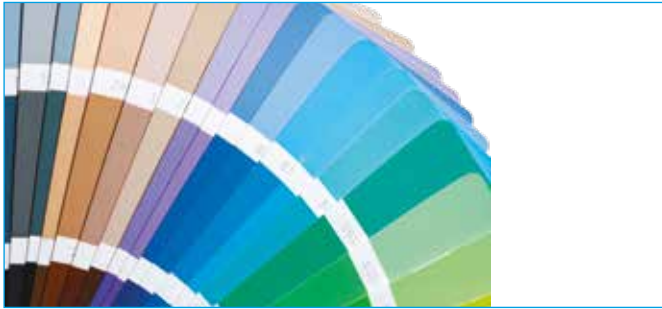

Knauf Danoline products can also be painted on site using a short mohair roller. When painting by roller, only the surface of the panel is painted and there will be contrast with the gypsum core in the perforations.

It is important to avoid getting paint in the perforation holes as this can affect sound absorption and the finished look. Therefore, a short-haired roller must be used and the paint should not be too thick. Do not over apply the paint in the perforated areas.

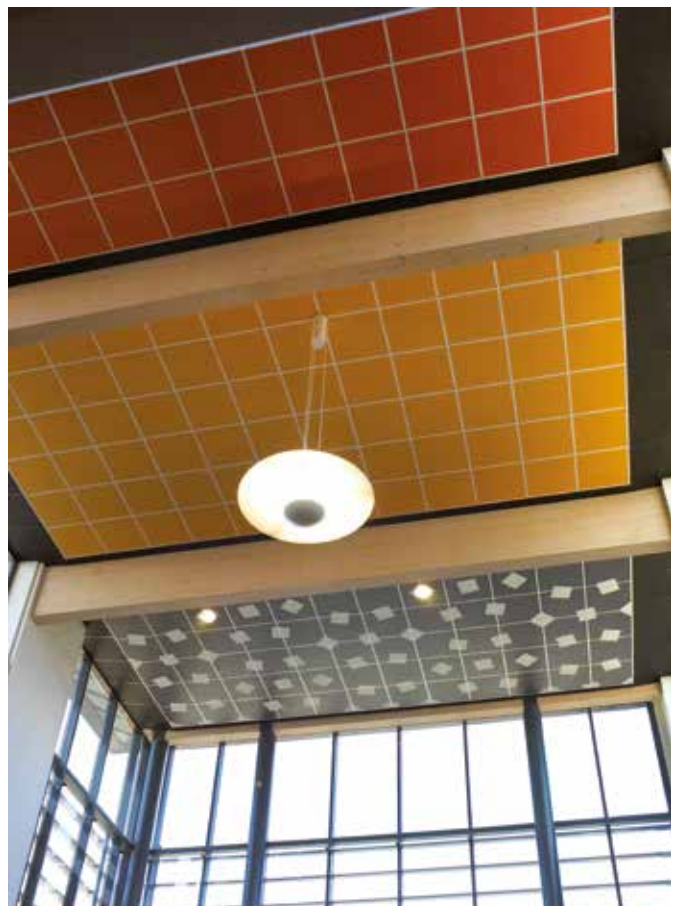

PROPERTIES

WARRANTY

Knauf Danoline's Guarantee of Quality

At Knauf Danoline we are proud of our ability to consistently supply high quality, gypsum-based, acoustic solutions for the benefit and comfort of our customers and end-users.

At Knauf Danoline we consistently deliver what we promise.

- Products manufactured to the highest international quality standards and guaranteed free of manufacturing defects for 5 years.
- Products and systems that can withstand the most stringent of global fire, acoustic and structural tests. Fire protection and acoustic performance guaranteed for 30 years.
- Solutions that provide design, indoor climate and sustainability value.
- High quality service and technical support guaranteeing up-to-date advice and help whatever your needs.
- Equal service to everyone.
- A fast response to the requests of all customers

Knauf Danoline has been in the construction industry for over 50 years and thanks to our know-how and affiliation with the Knauf group, we have the knowledge and capacity that secures flexibility in our production, insight in the building market requirements, and the basis for further development.

Knauf Danoline is committed to a constant future proofing of its product range and through annual product reviews and product optimisation projects in R&D, Knauf Danoline provides adaptable solutions that match the different demands from the market, whilst retaining their intrinsic ability to last a lifetime. In this way Knauf Danoline can consistently deliver:

- Easy to clean solutions that maintain their acoustic and indoor climate properties for their entire service life, even after repainting time and time again.
- Sustainable gypsum solutions that can last the lifetime of the building.
- Classic, timeless designs that maintain their aesthetical quality throughout their entire service life.

Maintaining a high level of quality service to our customers and other stakeholders is essential to our success and our ability to deliver what we promise. Therefore we educate our employees to have insight in markets and the skills and competencies required to ensure that they understand the needs and desires of all our customers. Only in this way can we be sure that we are able to consistently deliver what we promise.



UPKEEP & MAINTENANCE

Best Practice: Use of clean cotton gloves when handling painted and foil-covered product elements will ensure a good result and a ceiling without fingermarks.

PRODUCT CATEGORY	DEMOUNTABLE T-GRID CEILINGS	
PRODUCTS	VISONA, CONTUR, BELGRAVIA, MARKANT, PLAZA	DANOTILE, MEDLEY
SURFACE	White painted	Foil finish
UPKEEP	Designed for use under normal conditions, i.e. up to 70% RH and 25°C, e.g. in offices, institutions and similar premises. Belgravia, Markant, Plaza and Danotile 600x600 have also been tested at 90% RH at 30°C and can be used under more extreme conditions such as kitchens, laboratories and rooms with frequent and major changes in the temperature and air humidity. Special purpose, anticorrosion treated suspension systems should be used in areas of very high humidity.	
CLEANING	Dust is removed using a dry duster or vacuum cleaner. Marks can be removed with a damp cloth using normal cleaning practices and neutral cleaning solutions. Stubborn marks and minor damages should be wiped clean prior to repainting.	Dust is removed using a dry duster or vacuum cleaner. Marks can be removed with a damp cloth using a mild detergent if necessary. Stronger cleaning agents may be used where necessary to remove stubborn marks or where cleaning regimes require it. The product can also stand rigorous cleaning with concentrated disinfectants and detergents with high and low pH values (13.0 - 2.5).
REPAIR	More visible damages and scratches on the surface can be repaired using filler and finishing with sandpaper prior to repainting. When painting use Knauf Danoline repair paint or similar (as NCS 0700 or closest RAL colour 9003) and apply by paint roller. In case of surfaces painted with Medifend, make sure to use Medifend paint when repainting. Spray painting is not recommended on perforated products, as there is a risk of the spray paint being applied to the acoustic felt backing thereby altering the acoustic properties.	Damages and scratches are difficult to repair and therefore it is recommended to replace damaged tiles with new.
LAMP SUSPENSION	<p>DANOTILE: For sizes up to 625x625 mm and min. thickness 9mm, units of up to 3kg can be installed directly into the panel without reinforcement. For larger module sizes and all sizes in 6mm thickness, a reinforcement panel of sufficient strength can be installed behind the element. The reinforcement panel must extend all the way into the main runners, so that the weight is transferred to them. The total weight should not be greater than 3kg for each m² of ceiling. Where loads are greater than 3kg/m², additional hangers must be used. Units over 3kg, should be installed independently, so that they do not place any load on the ceiling.</p> <p>BELGRAVIA, MARKANT, PLAZA, MEDLEY: For sizes up to 625x625 mm not in Tangent perforation, units of up to 3kg can be installed directly into the panel without reinforcement. For larger module sizes and all sizes with Tangent perforation a reinforcement panel of sufficient strength can be installed behind the element. The reinforcement panel must extend all the way into the main runners, so that the weight is transferred to them. The total weight should not be greater than 3kg for each m² of ceiling. Where loads are greater than 3kg/m², additional hangers must be used. Units over 3kg, should be installed independently, so that they do not place any load on the ceiling.</p> <p>VISONA, CONTUR: With smaller units (of up to 3kg) a reinforcement panel of sufficient strength can be installed behind the element. The reinforcement panel must extend all the way into the main runners, so that the weight is transferred to them. The total weight should not be greater than 3kg for each m² of ceiling. Where loads are greater than 3kg/m², additional hangers must be used. Units over 3kg, should be installed independently, so that they do not place any load on the ceiling.</p>	
PRODUCT CATEGORY	SELF-SUPPORTING CEILINGS	
PRODUCTS	CORRIDOR 400, CORRIDOR SWING	
SURFACE	White painted	
UPKEEP	Designed for use under normal conditions, i.e. up to 70% RH and 25°C, e.g. in offices, institutions and similar premises. Corridor 400 has also been tested at 90% RH at 30°C and can be used under more extreme conditions such as kitchens, laboratories and rooms with frequent and major changes in the temperature and air humidity.	
CLEANING	Dust is removed using a dry duster or vacuum cleaner. Marks can be removed with a damp cloth using normal cleaning practices and neutral cleaning solutions. Stubborn marks and minor damages should be wiped clean prior to repainting.	
REPAIR	More visible damages and scratches on the surface can be repaired using filler and finishing with sandpaper prior to repainting. When painting use Knauf Danoline repair paint or similar (as NCS 0700 or closest RAL colour 9003) and apply by paint roller. In case of surfaces painted with Medifend, make sure to use Medifend paint when repainting. Spray painting is not recommended on perforated products, as there is a risk of the spray paint being applied to the acoustic felt backing thereby altering the acoustic properties.	
LAMP SUSPENSION	<p>CORRIDOR 400: Units weighing up to 3kg can be installed directly into the panel without reinforcement. N.B. The maximum cut-out, when installing in the centre of the panel is Ø265mm / 265x265 mm. Units over 3kg, should be supported independently, so that they do not place any load on the ceiling.</p> <p>CORRIDOR SWING: The ceiling tile may not bear additional weight from other installations.</p>	

UPKEEP & MAINTENANCE

Best Practice: Use of clean cotton gloves when handling painted and foil-covered product elements will ensure a good result and a ceiling without fingermarks. Handling the untreated panels with care will avoid

damage and surface contamination prior to painting and thereby ensure a good end result.

PRODUCT CATEGORY	NON-DEMOUNTABLE CEILING AND WALL LININGS			
PRODUCTS	DANOPANEL	DESIGNPANEL, TECTOPANEL, SOLOPANEL, STRATOPANEL	CONTRAPANEL, ADIT	KINOPANEL, AMFIPANEL
SURFACE	White painted	Untreated	Foil finish	Black painted
UPKEEP	<p>Designed for use under normal conditions, i.e. up to 70% RH and 25°C, e.g. in offices, institutions and similar premises.</p> <p>DESIGNPANEL, TECTOPANEL: The panels have also been tested at 90% RH at 30°C and can be used under more extreme conditions such as kitchens, laboratories and rooms with frequent and major changes in the temperature and air humidity. In areas of high humidity consideration should be given to anticorrosion suspension systems and durable/washable surface finishes.</p>		<p>CONTRAPANEL: Designed for use in sports halls and similar areas where conditions do not normally exceed 70% RH and 25°C.</p> <p>ADIT: The panels are custom made and designed for use under normal conditions, i.e. 70% and 25°C, e.g. in offices, institutions and similar premises unless otherwise advised.</p> <p>Adit and Contrapanel have also been tested at 90% RH at 30°C and can be used under more extreme conditions with frequent and major changes in temperature and air humidity.</p>	<p>Designed for use in cinemas, theatres, studios and similar premises under normal conditions, i.e. up to 70% RH and 25°C.</p>
CLEANING	<p>Dust is removed using a dry duster or vacuum cleaner. Removal of marks depends on the paint used on site, although a damp cloth using normal cleaning practices and neutral cleaning solutions is normally suitable for minor marks. In the case of stubborn marks or if in doubt refer to the paint manufacturer's recommendations.</p> <p>CONTRAPANEL: Dust is removed using a dry duster or vacuum cleaner. Marks can be removed with a damp cloth using normal cleaning practices and neutral cleaning solutions. On non-perforated tiles stronger cleaning agents may be used where necessary to remove stubborn marks or where cleaning regimes require it.</p>			
REPAIR	<p>More visible damages and scratches on the surface can be repaired using filler and finishing with sandpaper prior to repainting. When painting use Knauf Danoline repair paint or similar (as NCS 0700 or closest RAL colour 9003) and apply by paint roller. In case of surfaces painted with Medifend, make sure to use Medifend paint when repainting. Spray painting is not recommended on perforated products, as there is a risk of the spray paint being applied to the acoustic felt backing thereby altering the acoustic properties.</p>	<p>Use a paint roller to apply paint. Use the same paint as the original surface finish chosen. In case of surfaces painted with Medifend, make sure to use Medifend paint when repainting. Spray painting is not recommended on perforated products, as there is a great risk of the spray paint being applied to the acoustic felt backing thereby altering the acoustic properties.</p>	<p>Damages and scratches are difficult to repair and therefore it is recommended to replace damaged panels with new.</p>	<p>When painting use Knauf Danoline repair paint or similar (as NCS S9000-N) and apply by paint roller. In case of surfaces painted with Medifend, make sure to use Medifend paint when repainting. Spray painting is not recommended on perforated products, as there is a risk of the spray paint being applied to the acoustic felt backing thereby altering the acoustic properties.</p>
LAMP SUSPENSION	<p>The tile may not bear additional weight from other installations. Light objects up to a maximum of 3 kg/m² may be installed where they can be suspended from the furring system which must be able to bear the full weight.</p>	<p>Light objects up to a maximum of 3 kg can be suspended using appropriate fixings. Items over 3 kg must be suspended from the furring system which must be able to bear the full weight.</p>	<p>CONTRAPANEL: Light objects up to a maximum of 3 kg can be suspended using appropriate fixings. Items over 3 kg must be suspended from the furring system which must be able to bear the full weight.</p> <p>ADIT: The panel may not bear additional weight from other installations.</p>	<p>The panel may not bear additional weight from other installations.</p>

PRODUCT CATEGORY	DESIGN ELEMENTS	
PRODUCTS	CURVEX	MITEX
SURFACE	Untreated	Untreated
UPKEEP	<p>Designed for creating organic wall and ceiling shapes e.g. in offices, institutions and similar premises under normal conditions, i.e. up to 70% RH and 25°C.</p>	<p>Designed for creating clean-cut edges wall and ceiling shapes e.g. in offices, institutions and similar premises under normal conditions, i.e. up to 70% RH and 25°C.</p>
CLEANING	Dependent on the chosen surface finish.	
REPAIR	Dependent on the chosen surface finish.	
LAMP SUSPENSION	The panels are custom made and may not bear additional weight from other installations unless otherwise advised.	



Plaza A+ Unity 8 | 15 | 20, 600x600

**ROOM
FOR
EXPRESSION**





KNAUFDANOLINE

KNAUF DANOLINE
Kløvermarksvej 6
DK - 9500 Hobro

Phone: +45 96 57 3000

www.knaufdanoline.com
info@knaufdanoline.com

KNAUF DANOLINE
C/O Danogips Middle East
P.O. Box 53255
Jebel Ali Free Zone Dubai
United Arab Emirates

Phone: +971 4 8812281

www.knaufdanoline.com
info@knaufdanoline.com