

Detail A

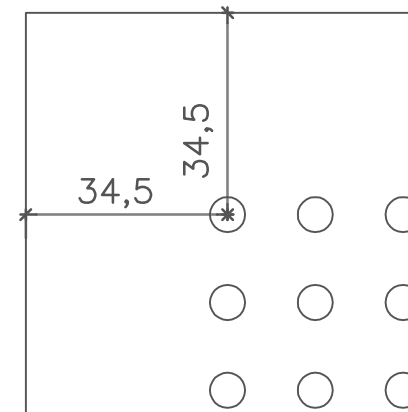

Detail B

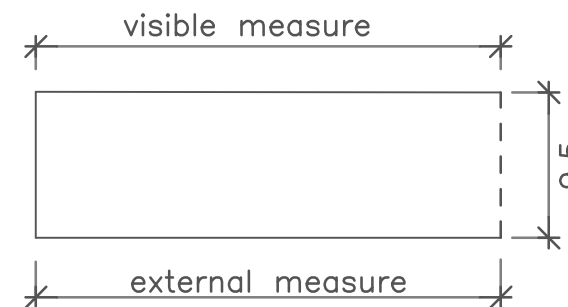

Detail C

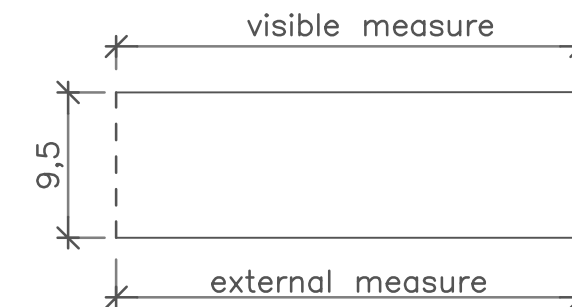

Perforation pattern:	Globe G1 (Ø6mm hole cc 15mm)
Perforation procentage:	10,2 %
Edge type:	Plaza A
Grid:	S15/S24
Module:	600 x 600 x 9,5mm
Visible measure (primary):	594 x 594mm
External measure (secondary):	594 x 594mm
A measure:	34,5mm
Perforation picture:	525 x 525mm (36 x 36 holes)

Project: Plaza A S15/S24, Module 600x600, Globe G1	MDM no.: 58825
Subject:	Scale:
	Date: 2018-07-03
	Rev.:
	Sign.: NPJ
	Project no.:
Knauf Danoline A/S Kløvermarksvej 6, DK-9500 Hobro T: +45 9657 3000 F: +45 9657 3001 www.knaufdanoline.com - info@knaufdanoline.com	File:

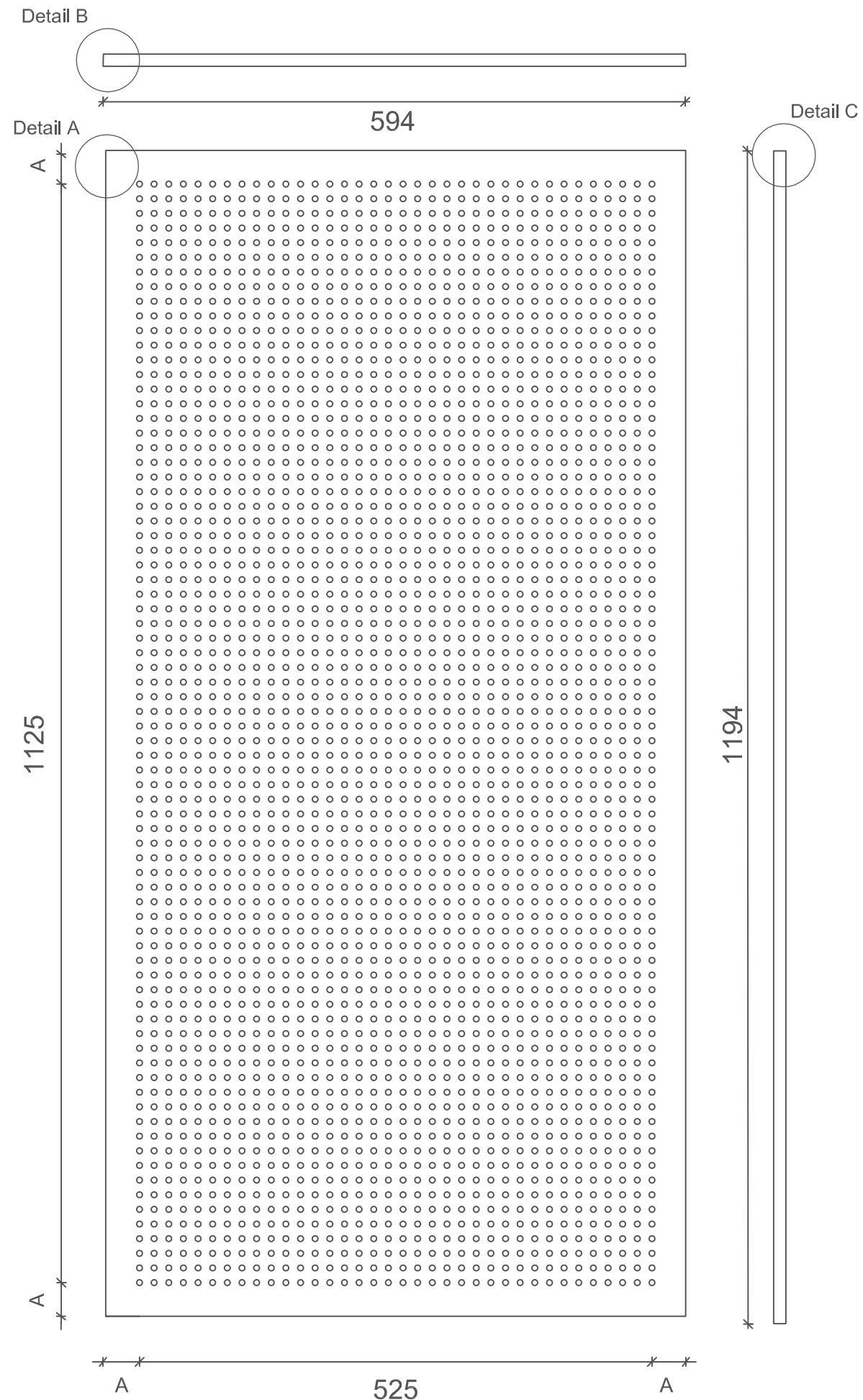

Detail A

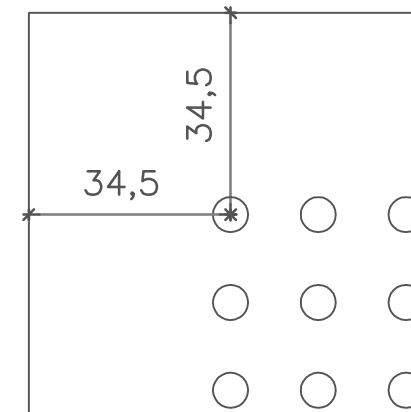

Detail B

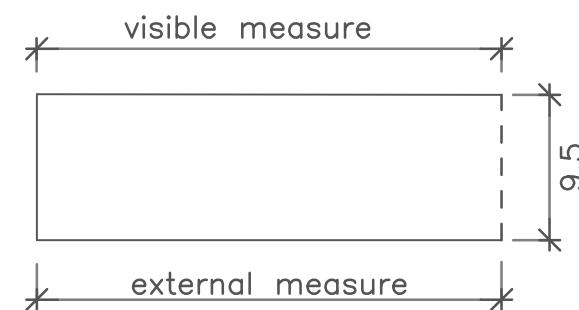

Detail C

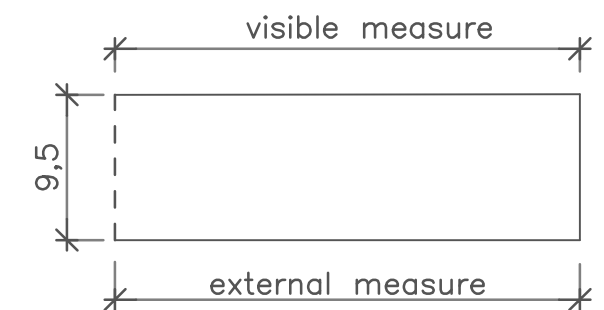

Perforation pattern: Globe G1 (Ø6mm hole cc 15mm)
 Perforation percentage: 10,7 %
 Edge type: Plaza A
 Grid: S15/S24
 Module: 600 x 1200 x 9,5mm
 Visible measure (primary): 594 x 1194mm
 External measure (secondary): 594 x 1194mm
 A measure: 34,5mm
 Perforation picture: 525 x 1125mm (36 x 76 holes)

Project: Plaza A S15/S24, Module 600x1200, Globe G1	MDM no.: 48625
Subject:	Scale:
	Date: 2018-07-12
	Rev.:
<small>Knauf Danoline A/S Kløvermarksvej 6, DK-9500 Hobro T: +45 9657 3000 F: +45 9657 3001 www.knaufdanoline.com - info@knaufdanoline.com</small>	Sign.: NPJ
	Project no.:
	File:

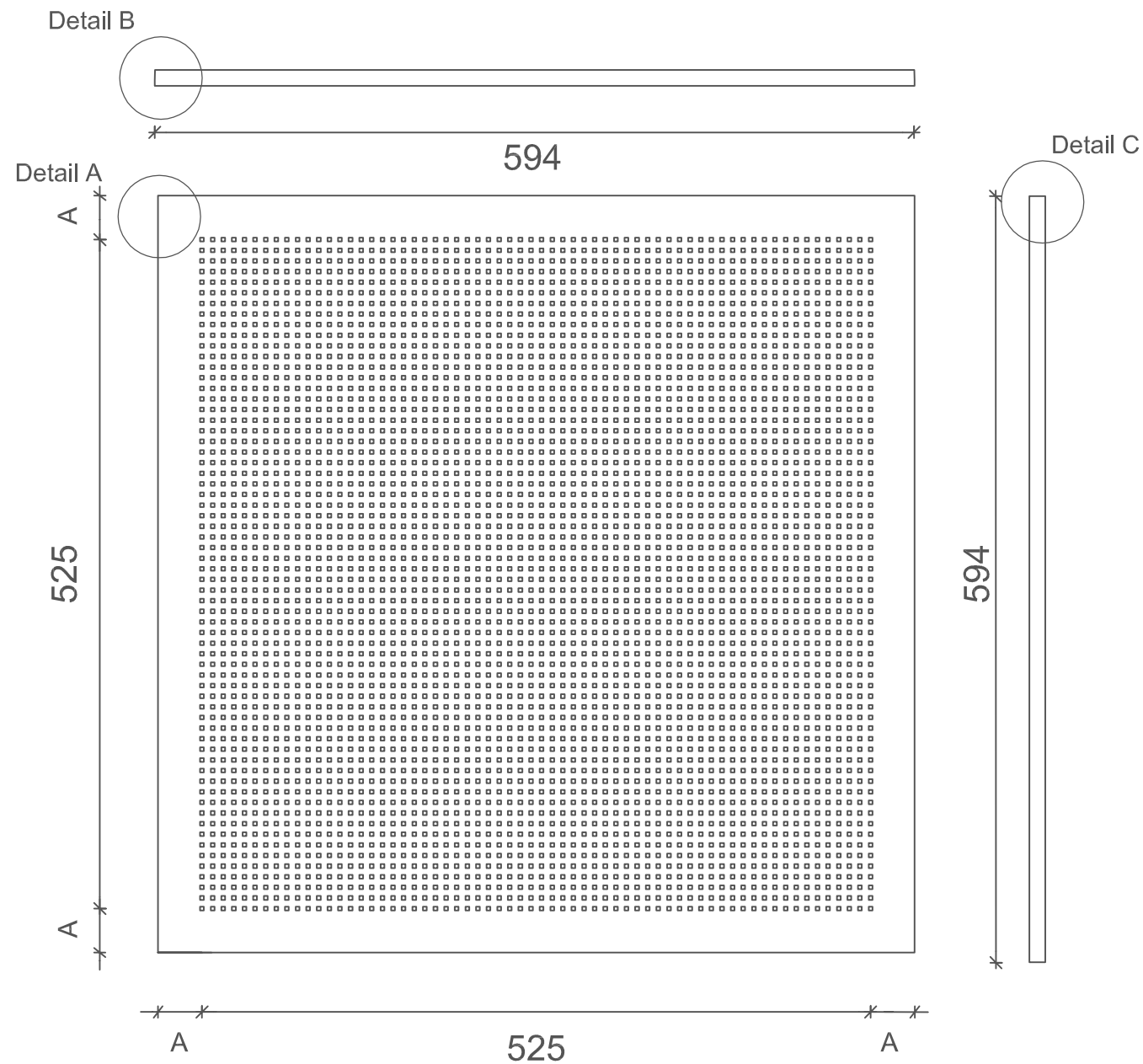

Detail A

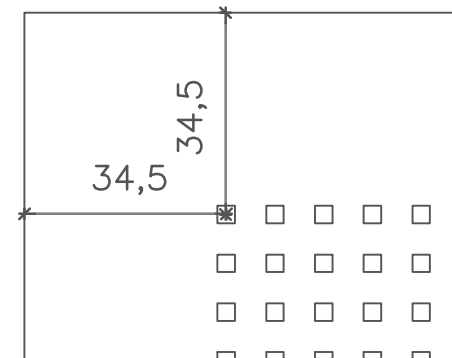

Detail B

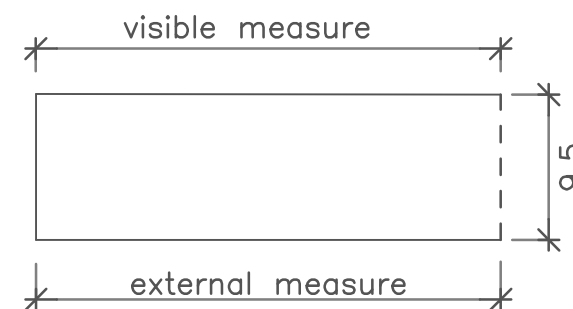

Detail C

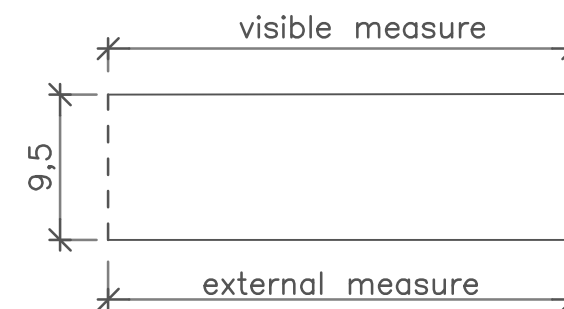

Perforation pattern:	Micro M1 (3x3mm holes cc 8,3mm)
Perforation percentage:	10,2 %
Edge type:	Plaza A
Grid:	S15/S24
Module:	600 x 600 x 9,5mm
Visible measure (primary):	594 x 594mm
External measure (secondary):	594 x 594mm
A measure:	34,5mm
Perforation picture:	525 x 525mm (64 x 64 holes)

Project: Plaza A S15/S24, Module 600x600, Micro M1	MDM no.:	58838
Subject:	Scale:	
	Date:	2018-07-12
	Rev.:	
	Sign.:	NPJ
	Project no.:	
Knauf Danoline A/S Kløvermarksvej 6, DK-9500 Hobro T: +45 9657 3000 F: +45 9657 3001 www.knaufdanoline.com - info@knaufdanoline.com	File:	

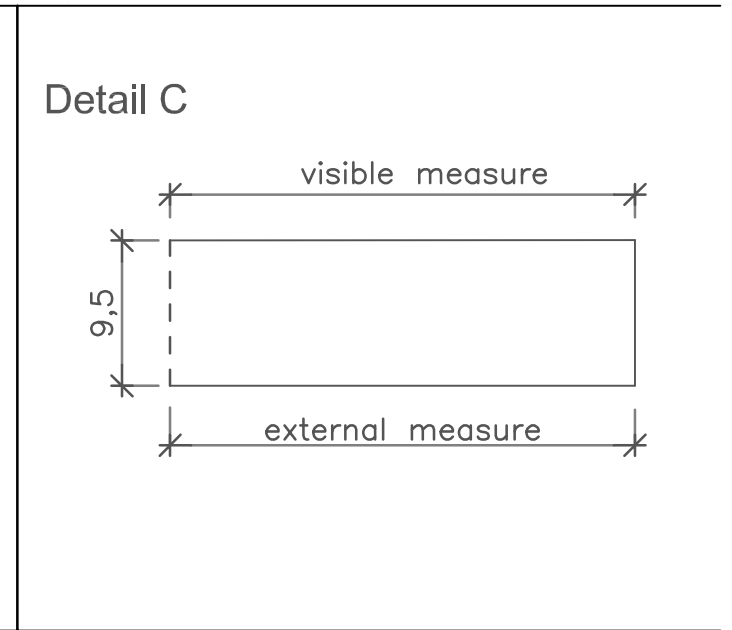
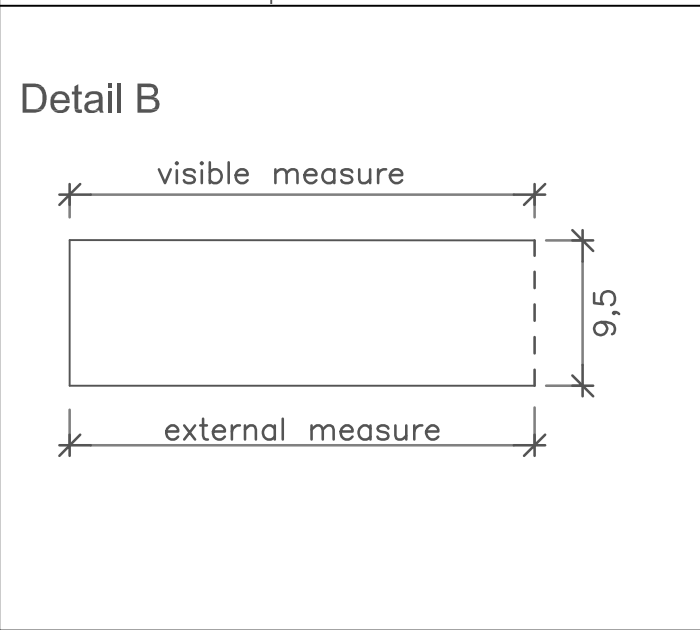
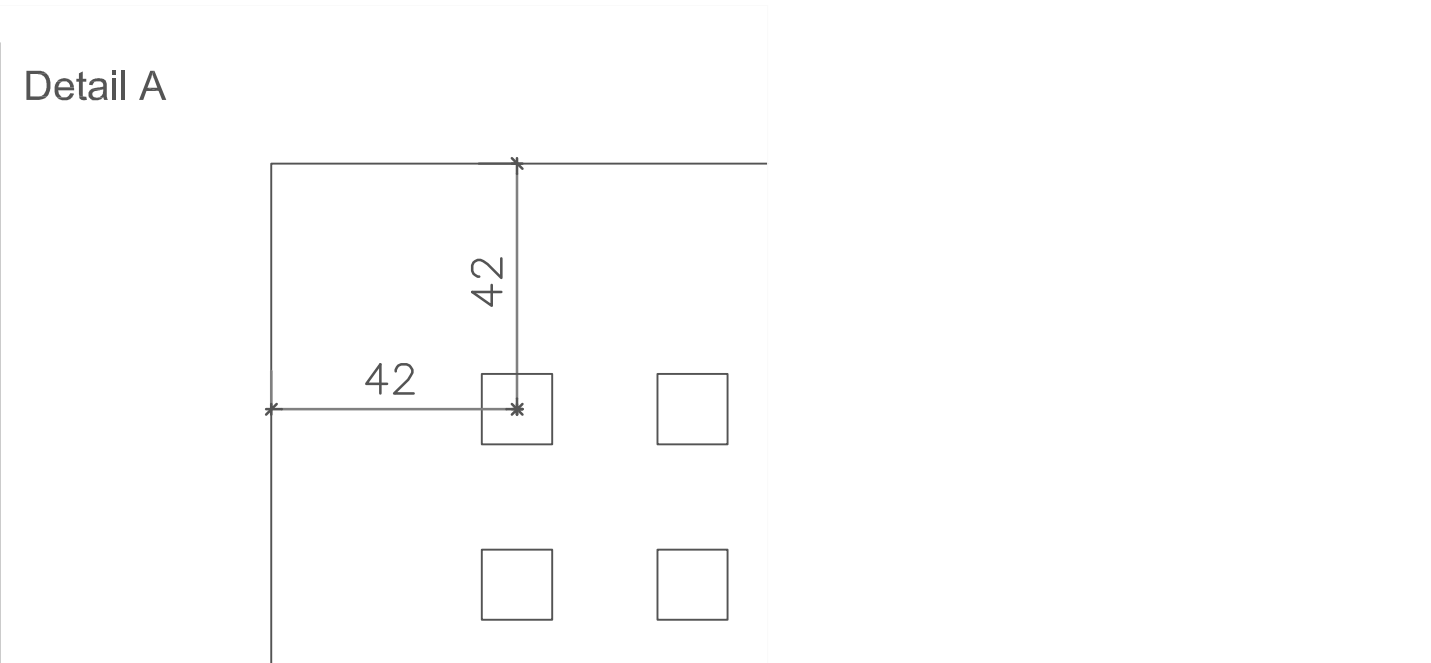
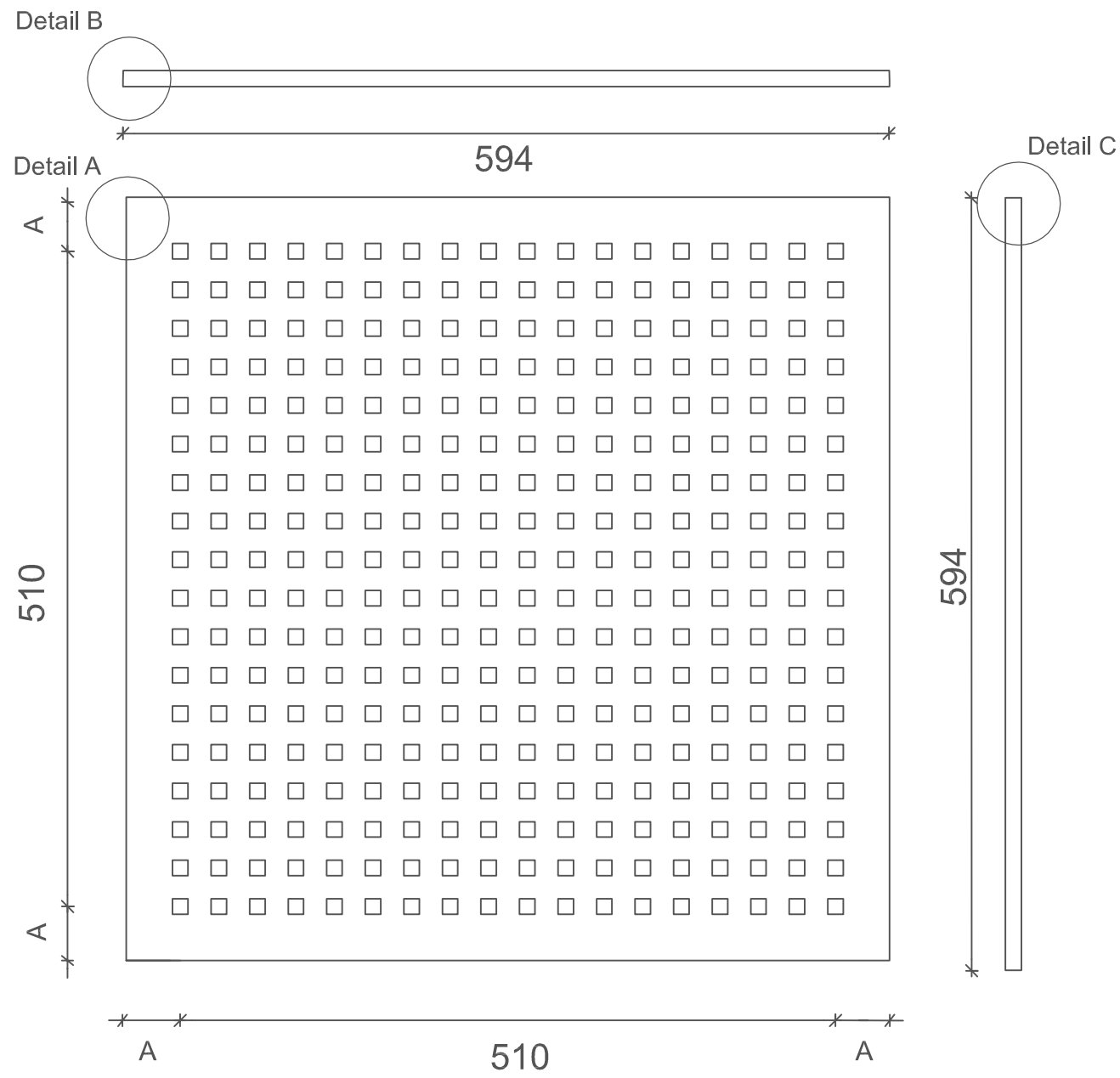

Perforation pattern: Quadril Q1 (12x12mm holes cc 30mm)
 Perforation procentage: 13 %
 Edge type: Plaza A
 Grid: S15/S24
 Module: 600 x 600 x 9,5mm
 Visible measure (primary): 594 x 594mm
 External measure (secondary): 594 x 594mm
 A measure: 42mm
 Perforation picture: 510 x 510mm (18 x 18 holes)

Project: Plaza A S15/S24, Module 600x600, Quadril Q1	MDM no.: 58824
Subject:	Scale:
	Date: 2018-07-11
	Rev.:
	Sign.: NPJ
	Project no.:
Knauf Danoline A/S Kløvermarksvej 6, DK-9500 Hobro T: +45 9657 3000 F: +45 9657 3001 www.knaufdanoline.com - Info@knaufdanoline.com	File:

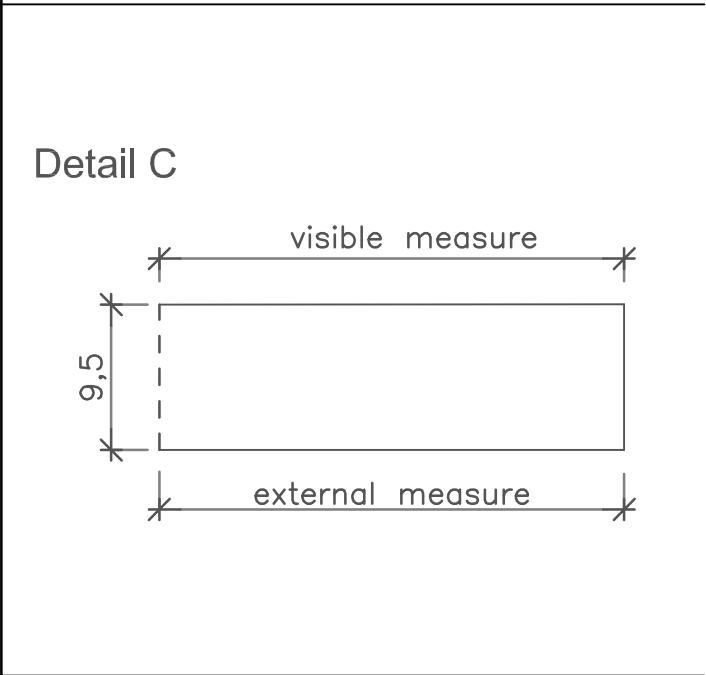
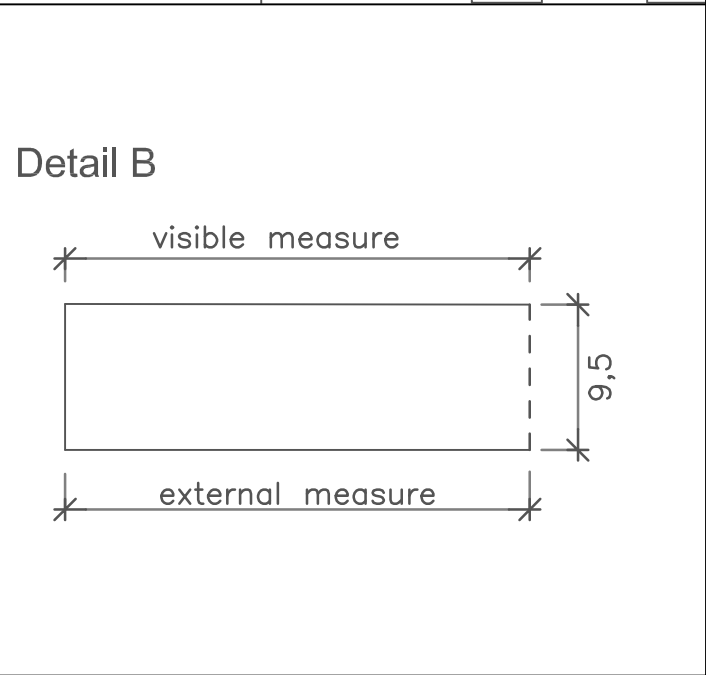
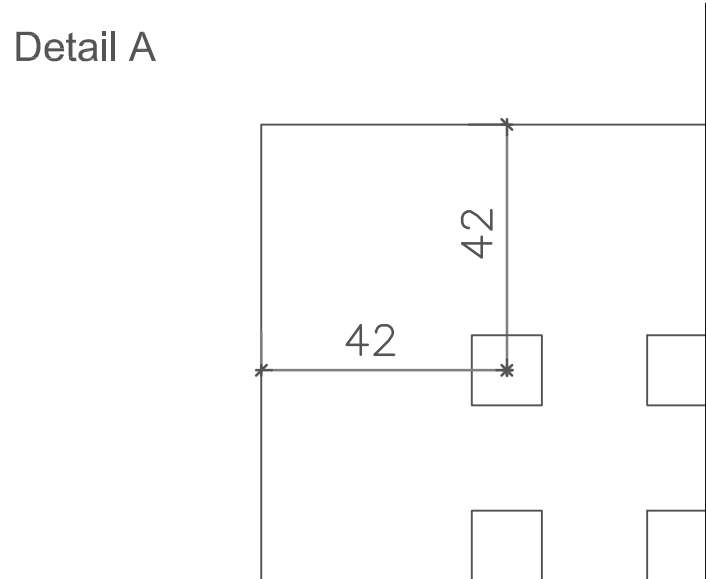
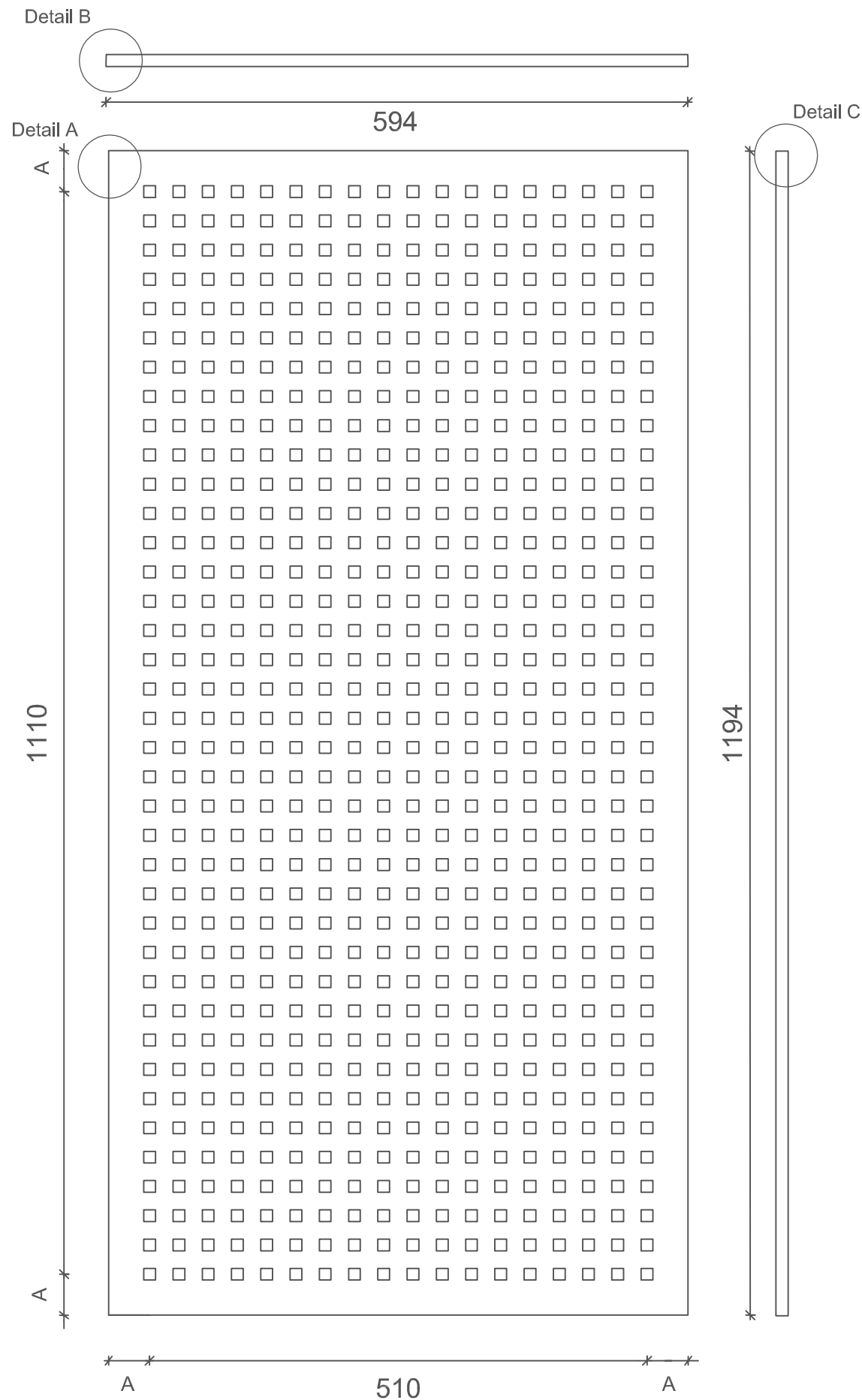

Perforation pattern: Quadril Q1 (12x12mm holes cc 30mm)
 Perforation procentage: 13,7 %
 Edge type: Plaza A
 Grid: S15/S24
 Module: 600 x 1200 x 9,5mm
 Visible measure (primary): 594 x 1194mm
 External measure (secondary): 594 x 1194mm
 A measure: 42mm
 Perforation picture: 510 x 1110mm (18 x 38 holes)

Project: Plaza A S15/S24, Module 600x1200, Quadril Q1	MDM no.: 50342
Subject:	Scale:
	Date: 2018-07-12
	Rev.:
	Sign.: NPJ
	Project no.:
	File:

Knauf Danoline A/S Klovermarksvej 6, DK-9500 Hobro
 T: +45 9657 3000 F: +45 9657 3001
 www.knaufdanoline.com - info@knaufdanoline.com

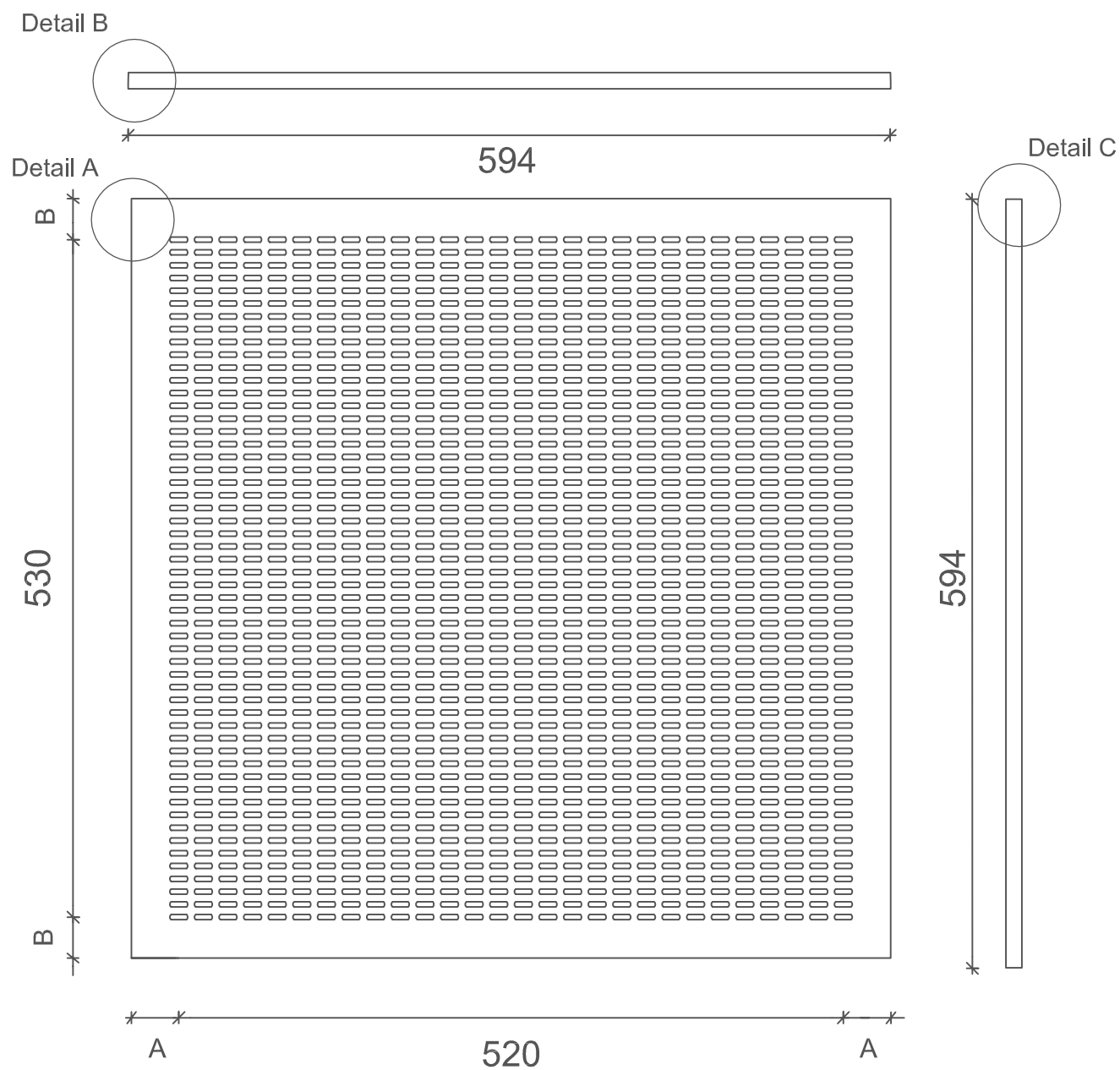

Detail A

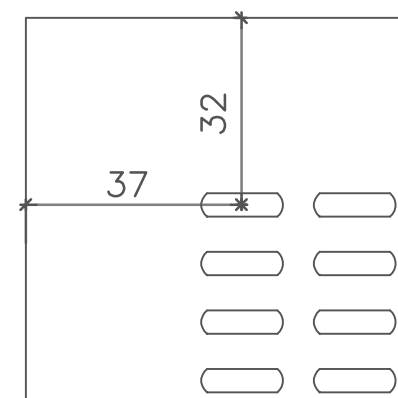

Detail B

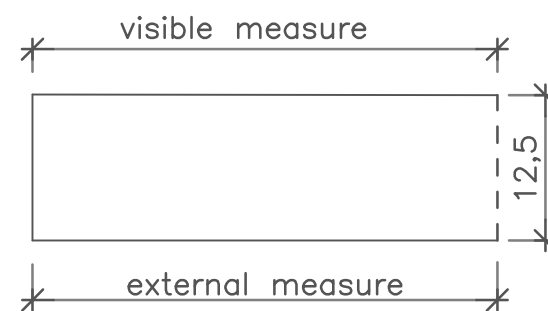

Detail C

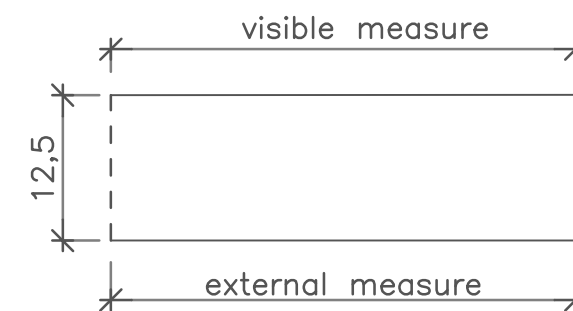

Perforation pattern:	Tangent T1 (4 x 14mm holes cc 10/20mm)
Perforation procentage:	21,3 %
Edge type:	Plaza A
Grid:	S15/S24
Module:	600 x 600 x 12,5mm
Visible measure (primary):	594 x 594mm
External measure (secondary):	594 x 594mm
A measure:	37mm
B measure:	32mm
Perforation picture:	530 x 520mm (54 x 28 holes)

Project: Plaza A S15/S24, Module 600x600, Tangent T1	MDM no.: 173226
Subject:	
	Scale:
	Date: 2018-07-12
	Rev.:
	Sign.: NPJ
	Project no.:
Knauf Danoline A/S Kløvermarksvej 6, DK-9500 Hobro T: +45 9657 3000 F: +45 9657 3001 www.knaufdanoline.com - info@knaufdanoline.com	File: