

Detail A

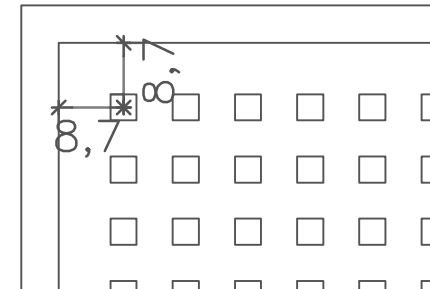

Detail B

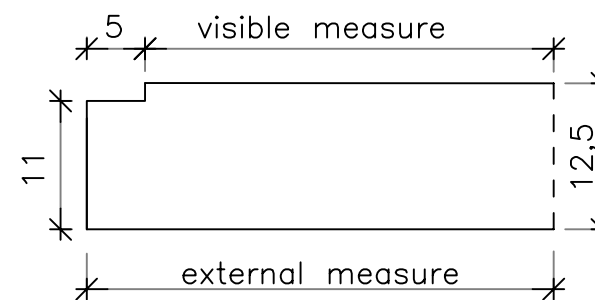

Detail C

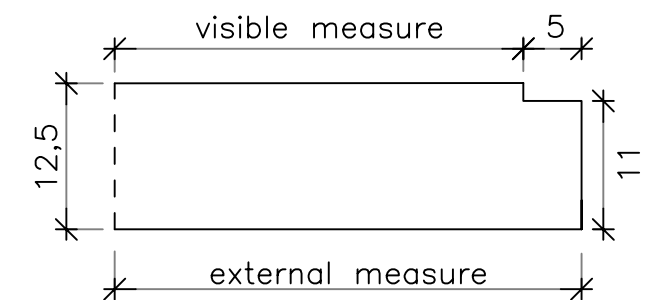

Perforation pattern: Unity 3 (3,5 x 3,5 mm holes cc 8,33 mm)
 Perforation percentage: 17,2 %
 Edge type: Plaza A+
 Grid: S15
 Module: 600 x 600 x 12,5mm
 Visible measure (primary): 584 x 584mm
 External measure (secondary): 594 x 594mm
 A measure: 8,7mm
 B measure: 6,95mm
 Perforation picture: 566,6 x 566,6mm (69 x 69 holes)

Project: Plaza A+ S15, Module 600x600, Unity 3	MDM no.: 469233
Subject:	Scale:
	Date: 2018-05-18
	Rev.:
	Sign.: NPJ
	Project no.:
Knauf Danoline A/S Kløvermarksvej 6, DK-9500 Hobro T: +45 9657 3000 F: +45 9657 3001 www.knaufdanoline.com - info@knaufdanoline.com	File:

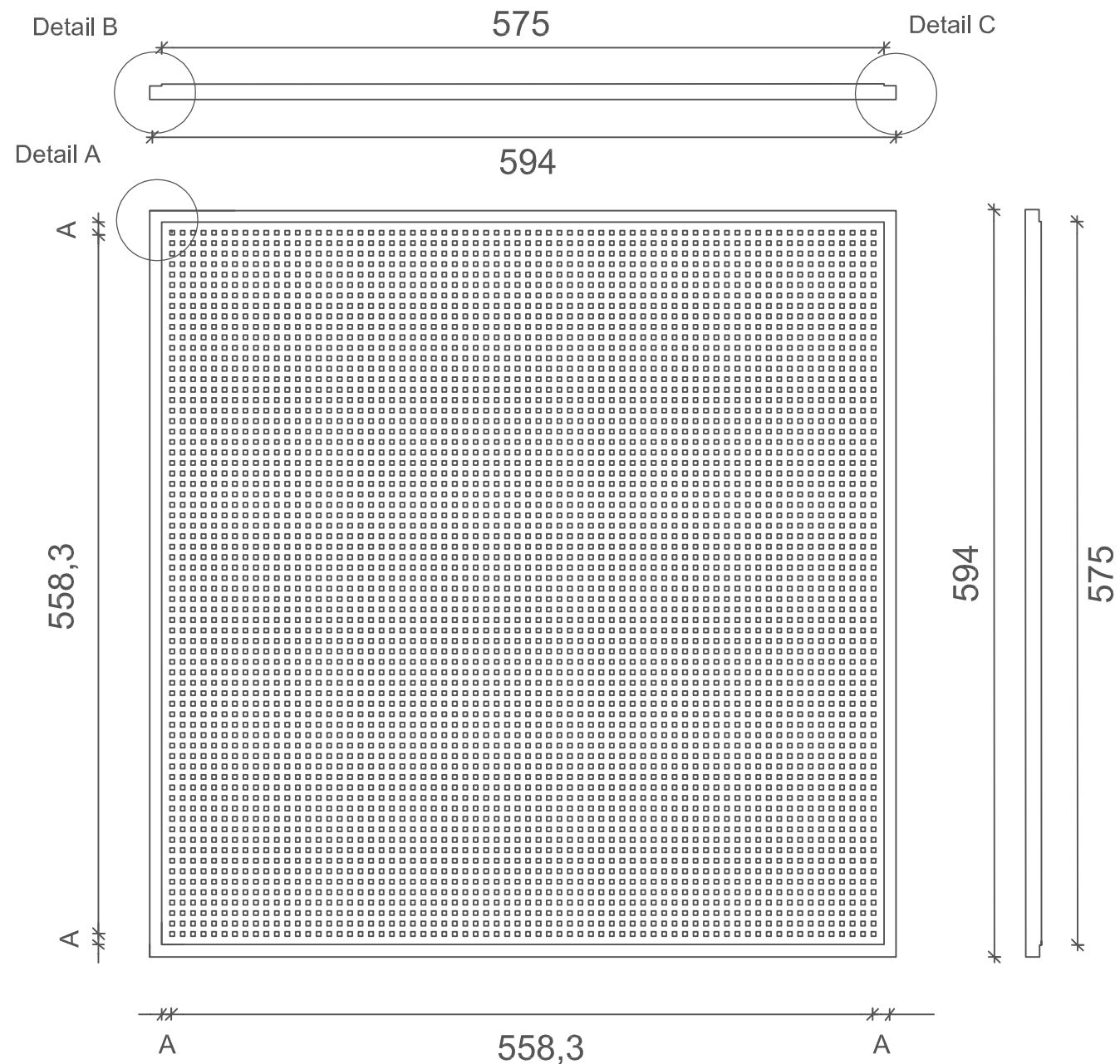

Detail A

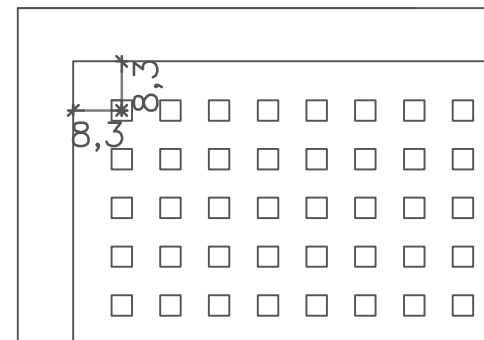

Detail B

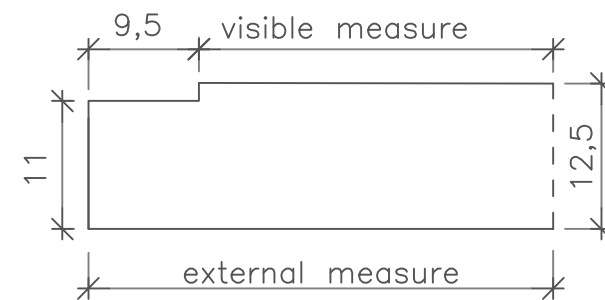

Detail C

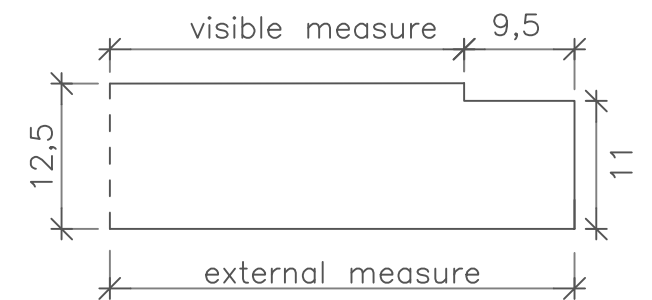

Perforation pattern: Unity 3 (3,5 x 3,5 mm holes cc 8,33 mm)
 Perforation procentage: 17,2 %
 Edge type: Plaza A+
 Grid: S24
 Module: 600 x 600 x 12,5mm
 Visible measure (primary): 575 x 575mm
 External measure (secondary): 594 x 594mm
 A measure: 8,3mm
 Perforation picture: 558,3 x 558,3mm (68 x 68 holes)

Project: Plaza A+ S24, Module 600x600, Unity 3

Subject:



Knauf Danoline A/S Kløvermarksvej 6, DK-9500 Hobro
 T: +45 9657 3000 F: +45 9657 3001
 www.knaufdanoline.com - Info@knaufdanoline.com

Draw. no.:

473243

Scale:

Date: 2018-05-08

Rev.:

Sign.: NPJ

Project no.:

File:

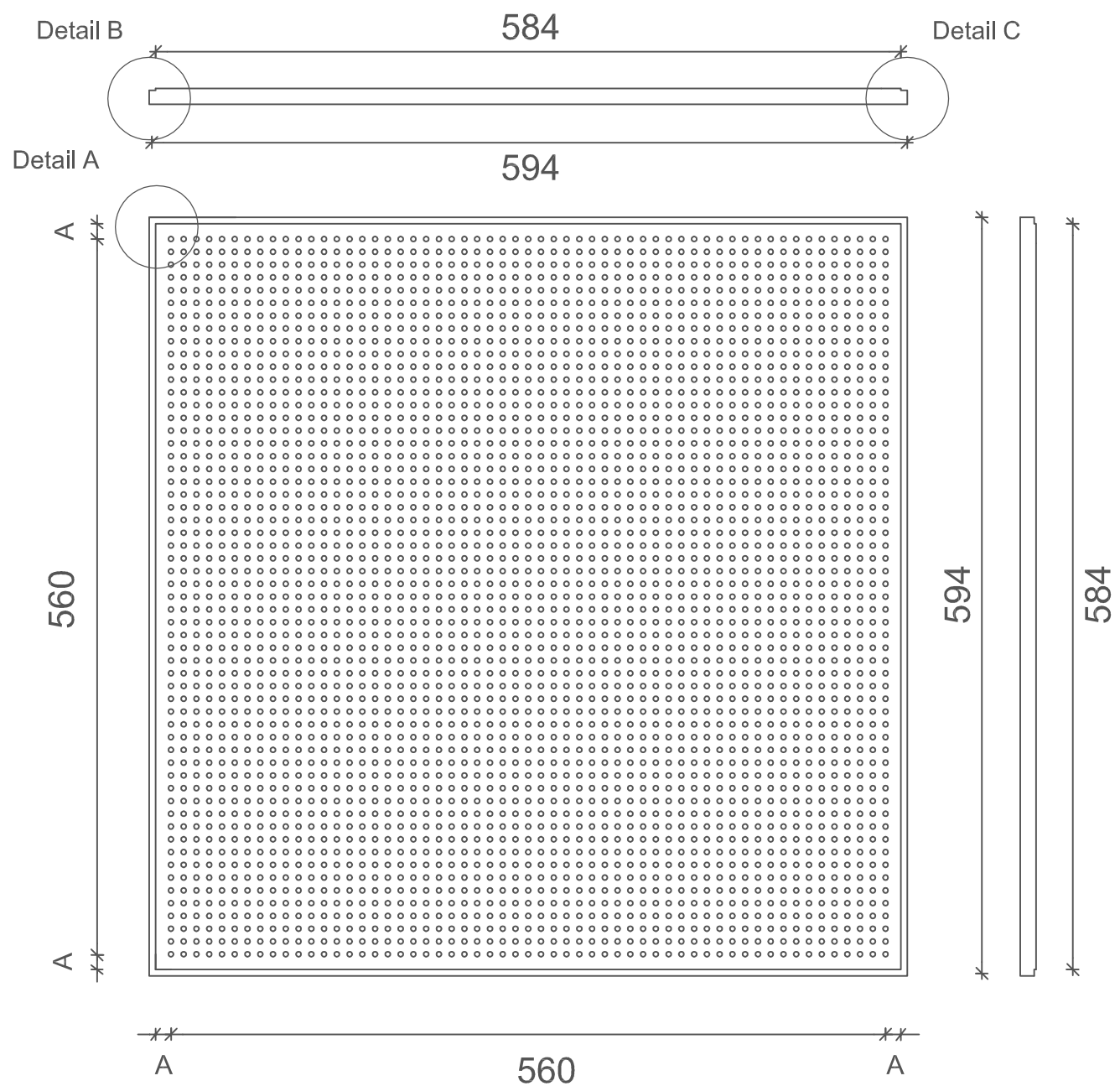

Detail A

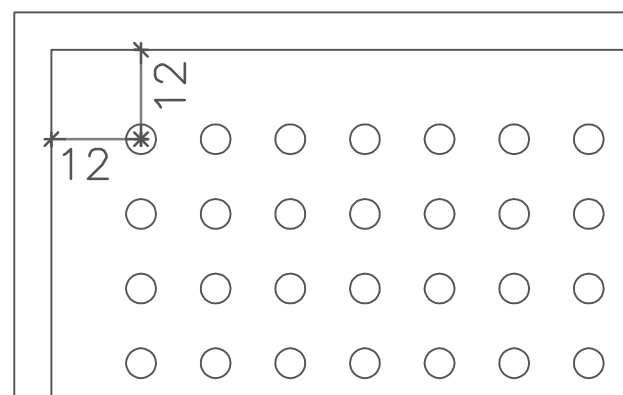

Detail B

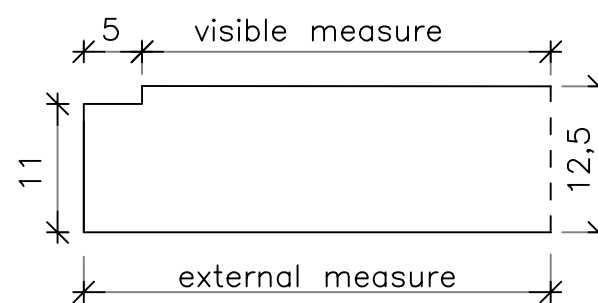

Detail C

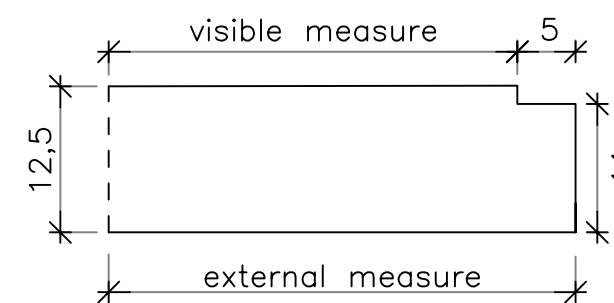

Perforation pattern: Unity 4 (Ø4 mm hole cc 10 mm)
 Perforation percentage: 12,2 %
 Edge type: Plaza A+
 Grid: S15
 Module: 600 x 600 x 12,5mm
 Visible measure (primary): 584 x 584mm
 External measure (secondary): 594 x 594mm
 A measure: 12mm
 Perforation picture: 560 x 560mm (57 x 57 holes)

Project: Plaza A+ S15, Module 600x600, Unity 4	MDM no.: 532684
Subject:	Scale:
	Date: 2018-05-30
	Rev.:
	Sign.: NPJ
	Project no.:
Knauf Danoline A/S Kløvermarksvej 6, DK-9500 Hobro T: +45 9657 3000 F: +45 9657 3001 www.knaufdanoline.com - info@knaufdanoline.com	File:

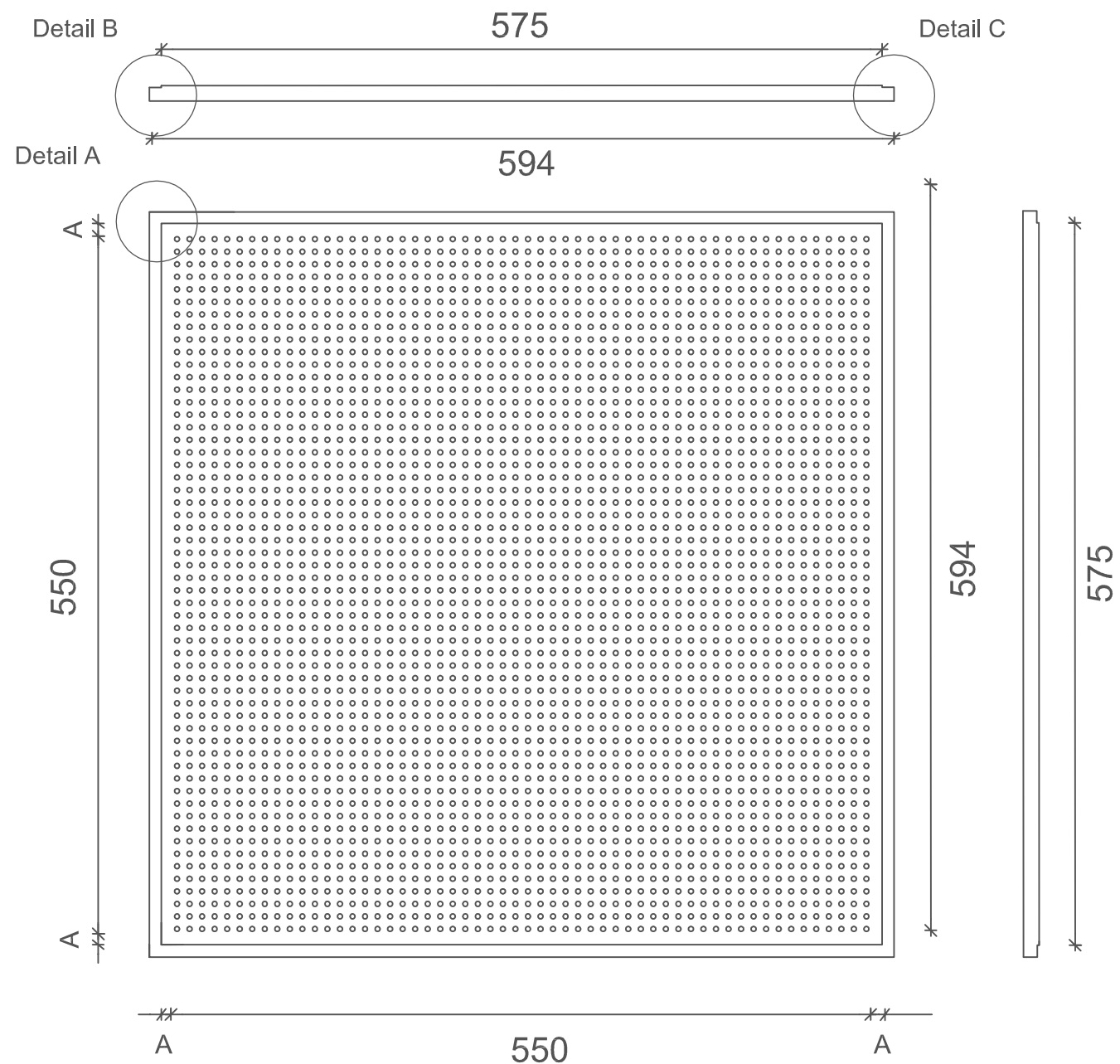

Detail A

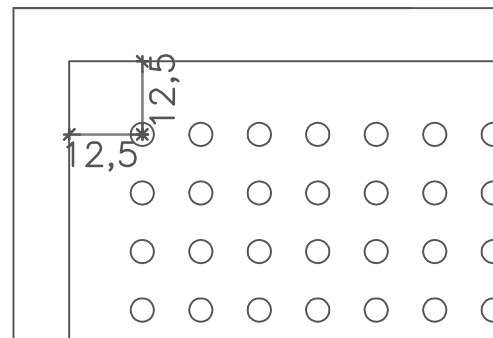

Detail B

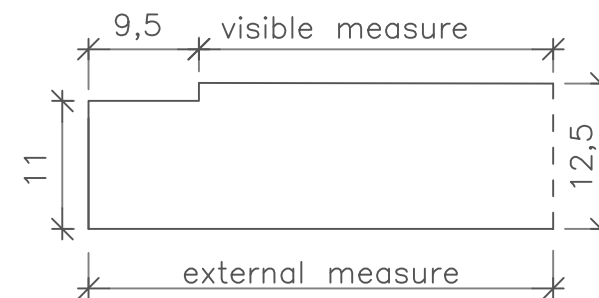

Detail C

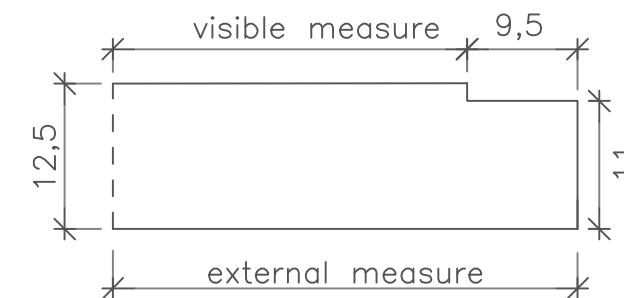

Perforation pattern:	Unity 4 (Ø4mm hole cc 10 mm)
Perforation procentage:	12,2 %
Edge type:	Plaza A+
Grid:	S24
Module:	600 x 600 x 12,5mm
Visible measure (primary):	575 x 575mm
External measure (secondary):	594 x 594mm
A measure:	12,5mm
Perforation picture:	550 x 550mm (56 x 56 holes)

Project: Plaza A+ S24, Module 600x600, Unity 4

Subject:

KNAUF DANOLINE

Knauf Danoline A/S Kløvermarksvej 6, DK-9500 Hobro
T: +45 9657 3000 F: +45 9657 3001
www.knaufdanoline.com - Info@knaufdanoline.com

Draw. no.:

532687

Scale:

Date: 2018-05-08

Rev.:

Sign.: NPJ

Project no.:

File:

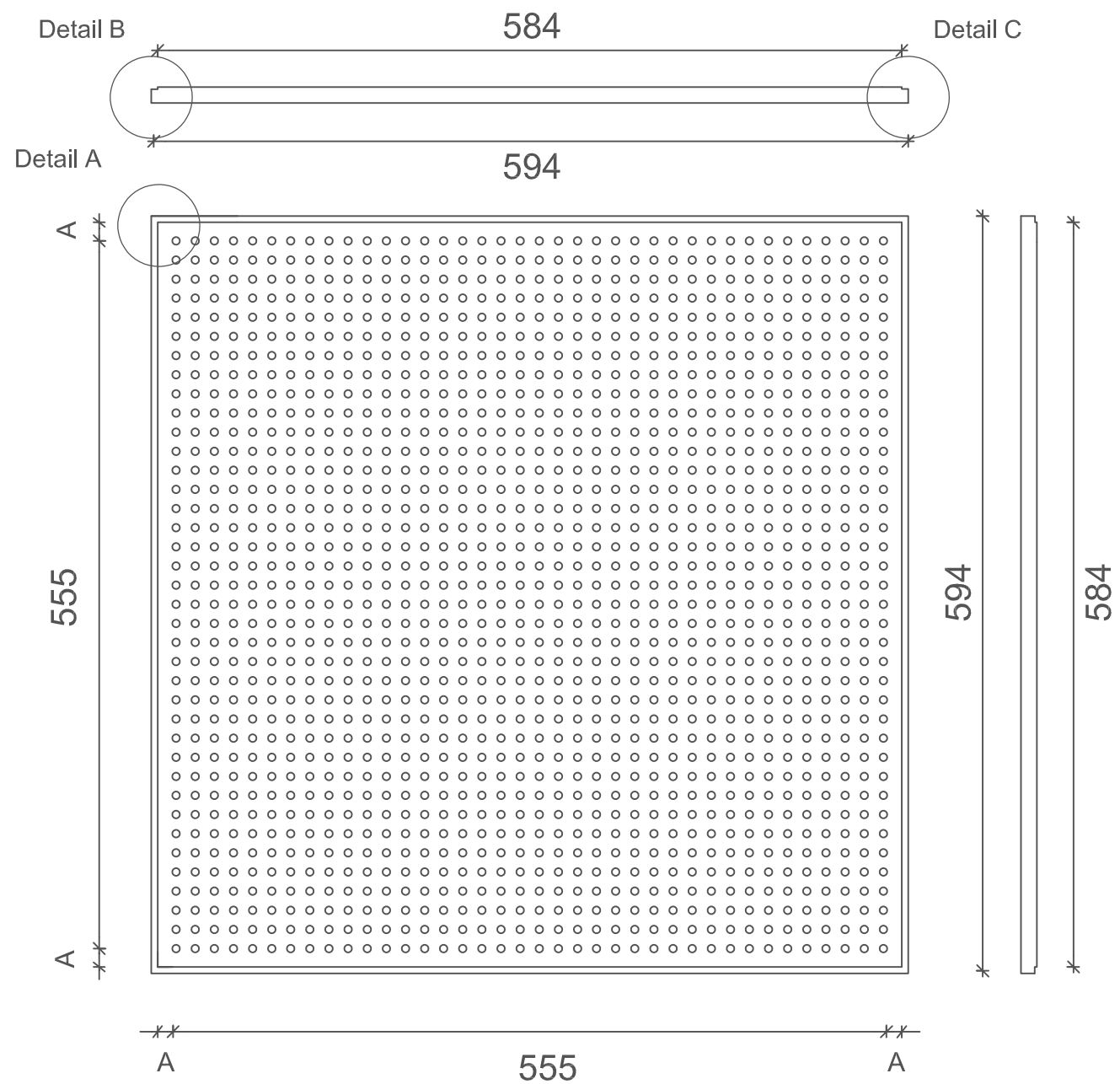

Detail A

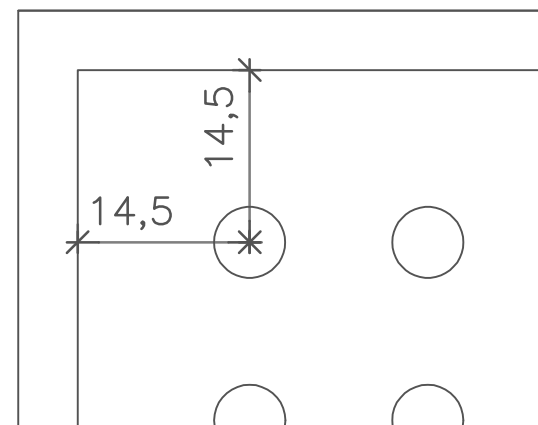

Detail B

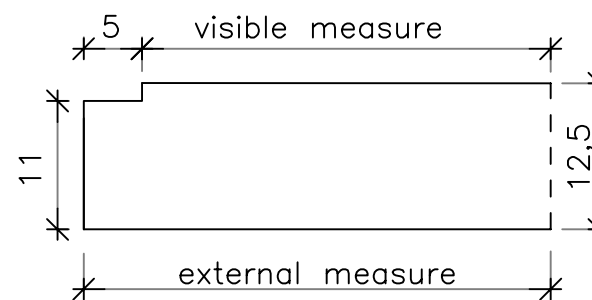

Detail C

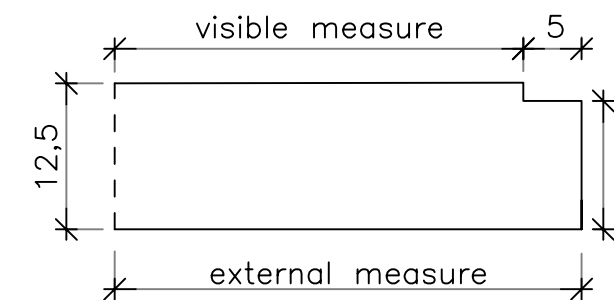

Perforation pattern:	Unity 6 (Ø6 mm hole cc 15 mm)
Perforation procentage:	11,9 %
Edge type:	Plaza A+
Grid:	S15
Module:	600 x 600 x 12,5mm
Visible measure (primary):	584 x 584mm
External measure (secondary):	594 x 594mm
A measure:	14,5mm
Perforation picture:	555 x 555mm (38 x 38 holes)

Project: Plaza A+ S15, Module 600x600, Unity 6

Subject: White acoustic fleece backing

MDM no.:

708705

Scale:

Date: 2020-10-05

Rev.:

Sign.: FKS

Project no.:

File:

KNAUF DANOLINE

Knauf Danoline A/S Kløvermarksvej 6, DK-9500 Hobro
 T: +45 9657 3000 F: +45 9657 3001
 www.knaufdanoline.com - info@knaufdanoline.com

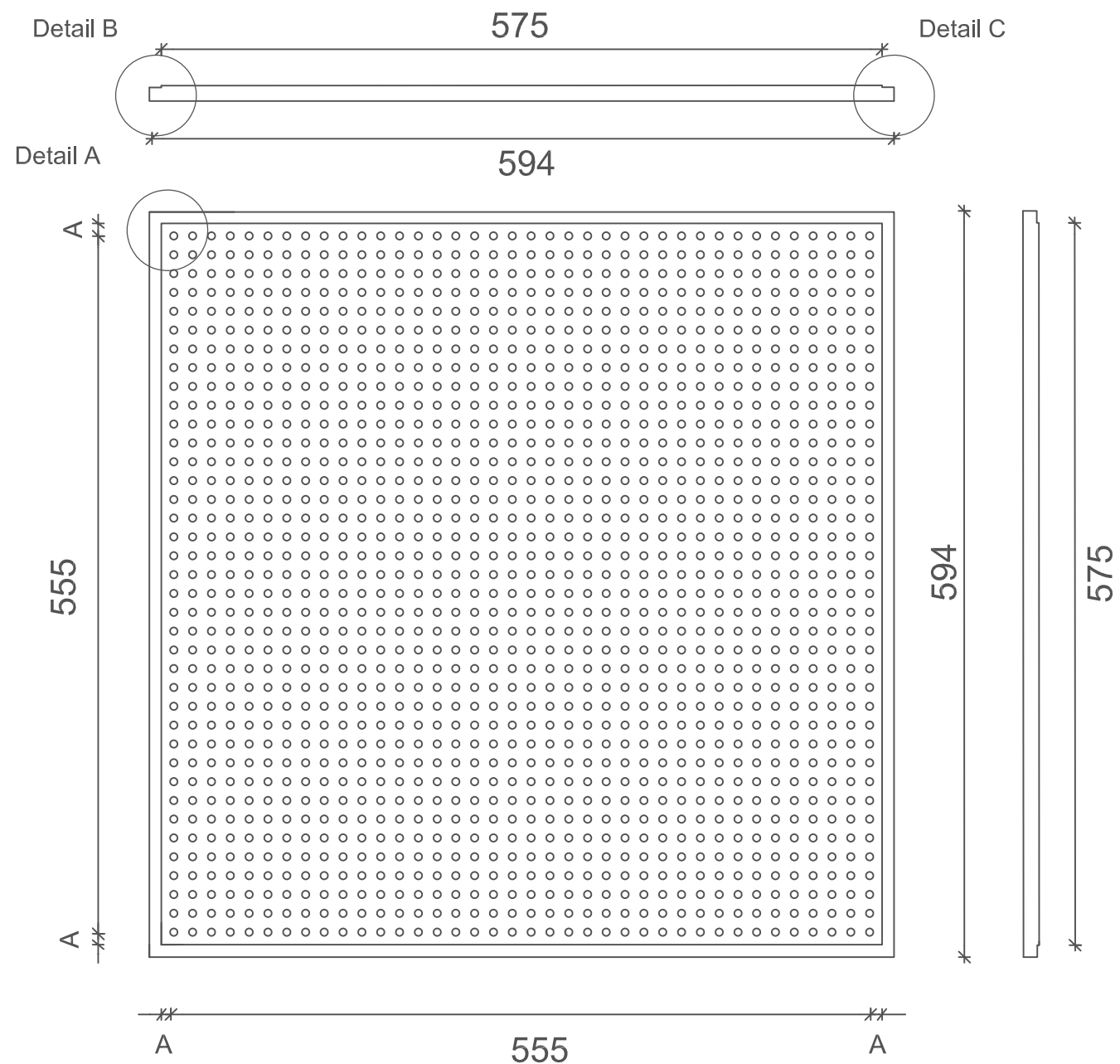

Detail A

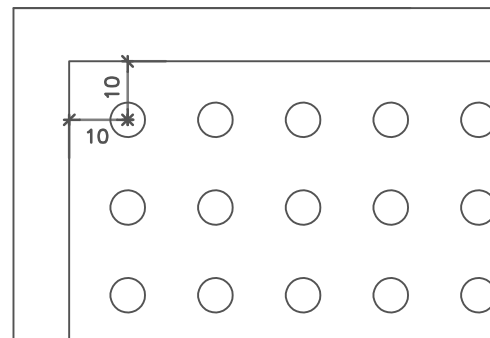

Detail B

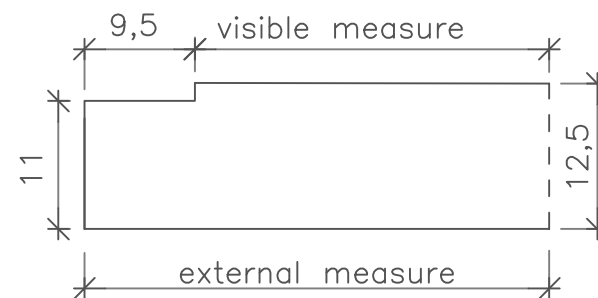

Detail C

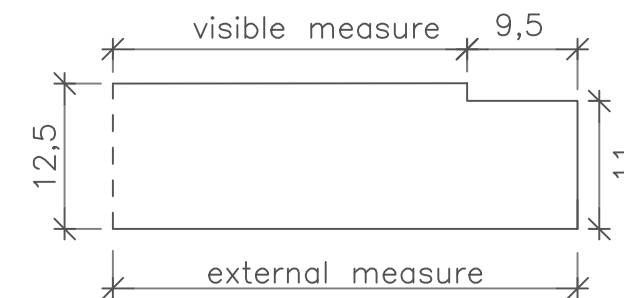

Perforation pattern:	Unity 6 (Ø6mm hole cc 15 mm)
Perforation procentage:	11,9 %
Edge type:	Plaza A+
Grid:	S24
Module:	600 x 600 x 12,5mm
Visible measure (primary):	575 x 575mm
External measure (secondary):	594 x 594mm
A measure:	10mm
Perforation picture:	555 x 555mm (38 x 38 holes)

Project: Plaza A+ S24, Module 600x600, Unity 6

Subject: White acoustic fleece backing

KNAUF DANOLINE

Knauf Danoline A/S Kløvermarksvej 6, DK-9500 Hobro
T: +45 9657 3000 F: +45 9657 3001
www.knaufdanoline.com - Info@knaufdanoline.com

Draw. no.:

708706

Scale:

Date: 2020-10-05

Rev.:

Sign.: FKS

Project no.:

File:

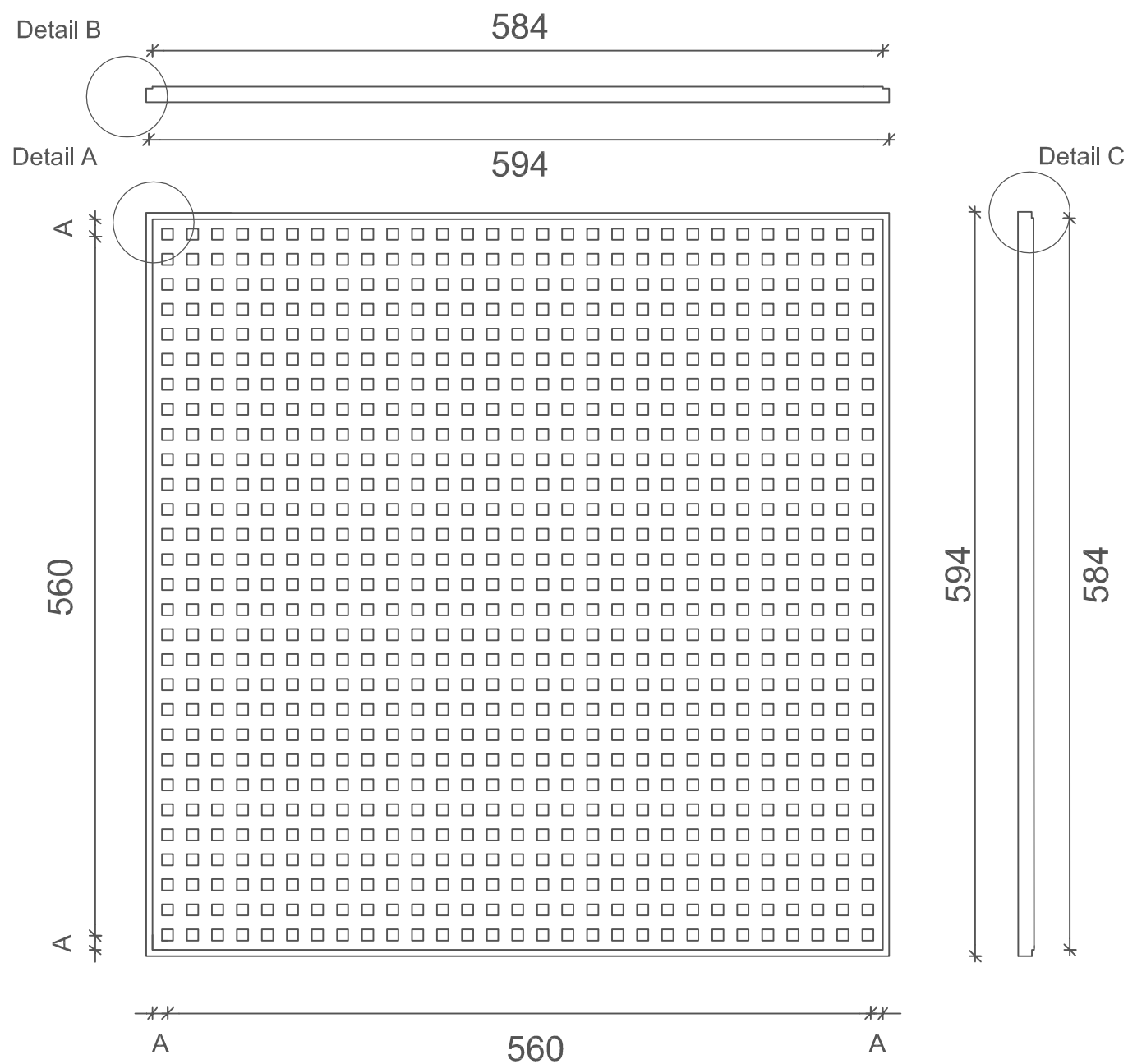

Detail A

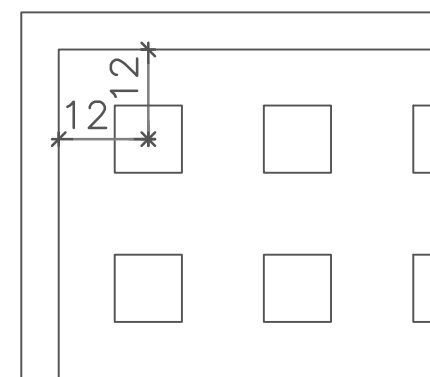

Detail B

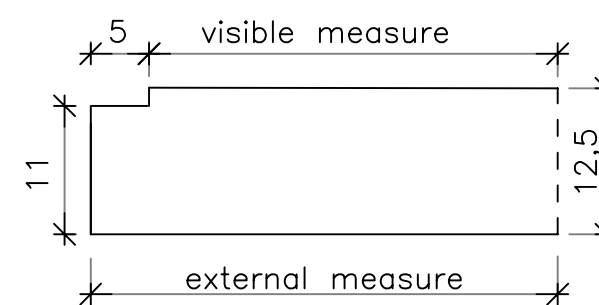

Detail C

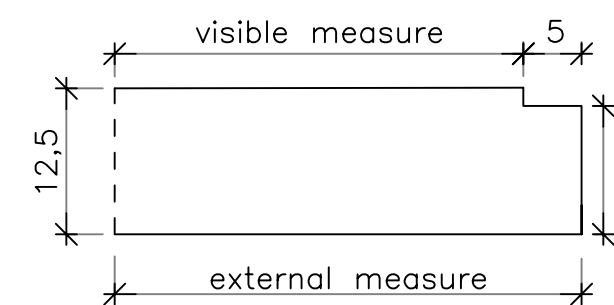

Perforation pattern:	Unity 9 (9x9mm holes cc 20 mm)
Perforation percentage:	18,9 %
Edge type:	Plaza A+
Grid:	S15
Module:	600 x 600 x 12,5mm
Visible measure (primary):	584 x 584mm
External measure (secondary):	594 x 594mm
A measure:	12mm
Perforation picture:	560 x 560mm (29 x 29 holes)

Project: Plaza A+ S15, Module 600x600, Unity 9

Subject:



Knauf Danoline A/S Kløvermarksvej 6, DK-9500 Hobro
 T: +45 9657 3000 F: +45 9657 3001
 www.knaufdanoline.com - info@knaufdanoline.com

MDM no.:

613752

Scale:

Date: 2018-07-12

Rev.:

Sign.: NPJ

Project no.:

File:

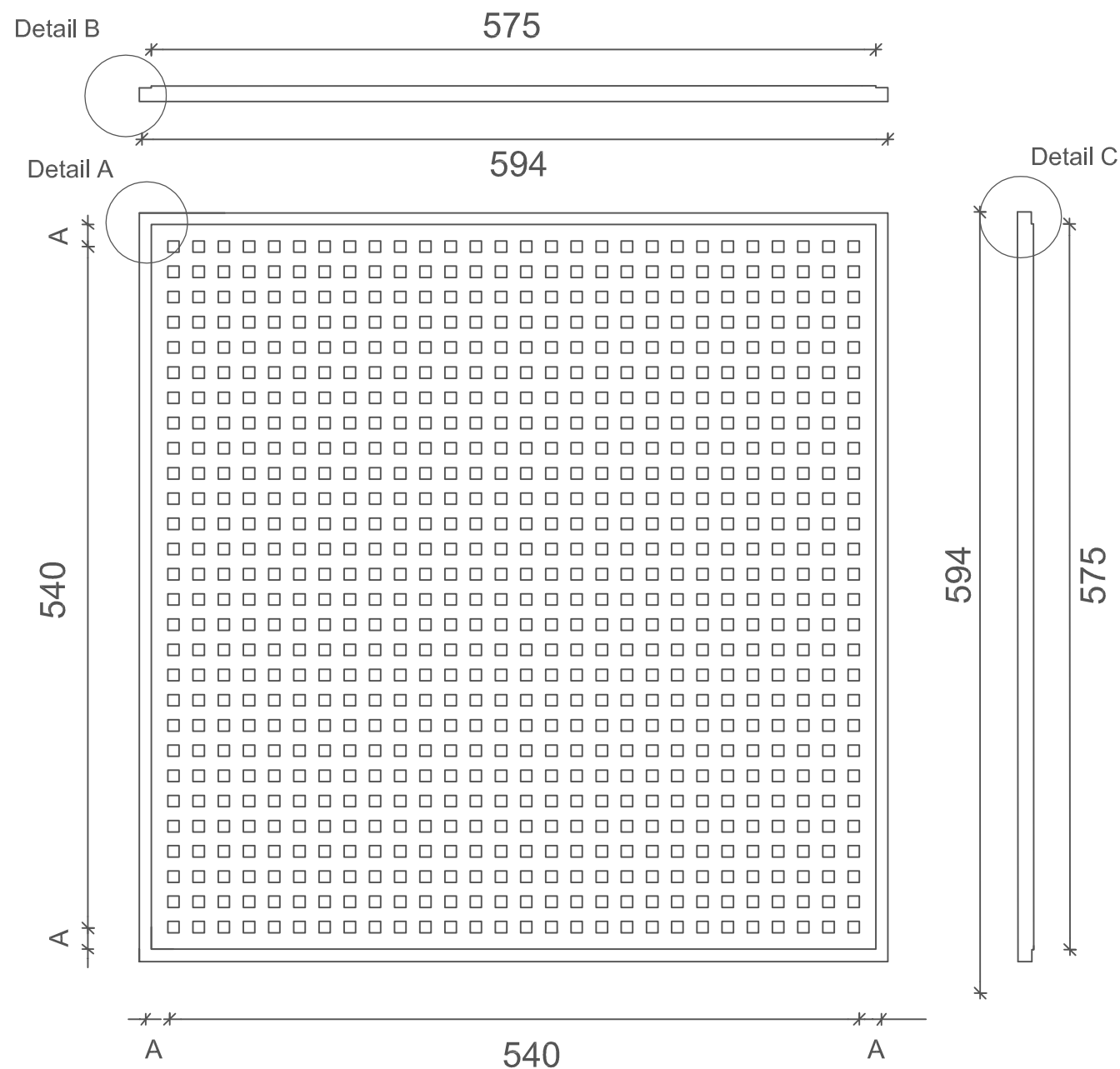

Detail A

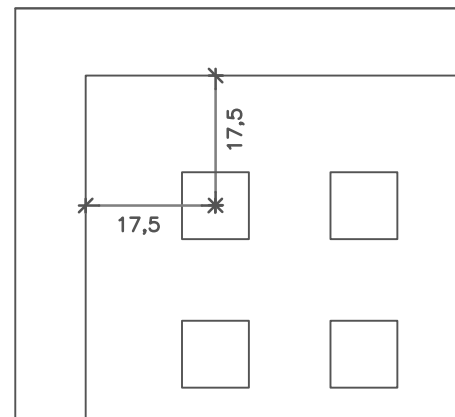

Detail B

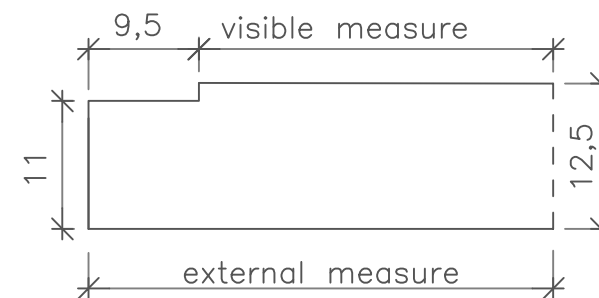

Detail C

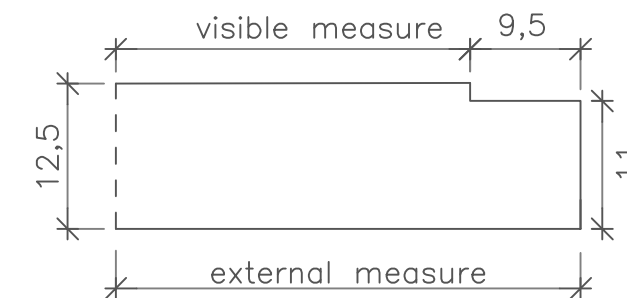

Perforation pattern: Unity 9 (9x9mm holes cc 20 mm)
 Perforation procentage: 18,9 %
 Edge type: Plaza A+
 Grid: S24
 Module: 600 x 600 x 12,5mm
 Visible measure (primary): 575 x 575mm
 External measure (secondary): 594 x 594mm
 A measure: 17,5mm
 Perforation picture: 540 x 540mm (28 x 28 holes)

Project: Plaza A+ S24, Module 600x600, Unity 9	Draw. no.: 613756
Subject:	Scale:
	Date: 2018-07-12
	Rev.:
	Sign.: NPJ
	Project no.:
Knauf Danoline A/S Kløvermarksvej 6, DK-9500 Hobro T: +45 9657 3000 F: +45 9657 3001 www.knaufdanoline.com - Info@knaufdanoline.com	File:

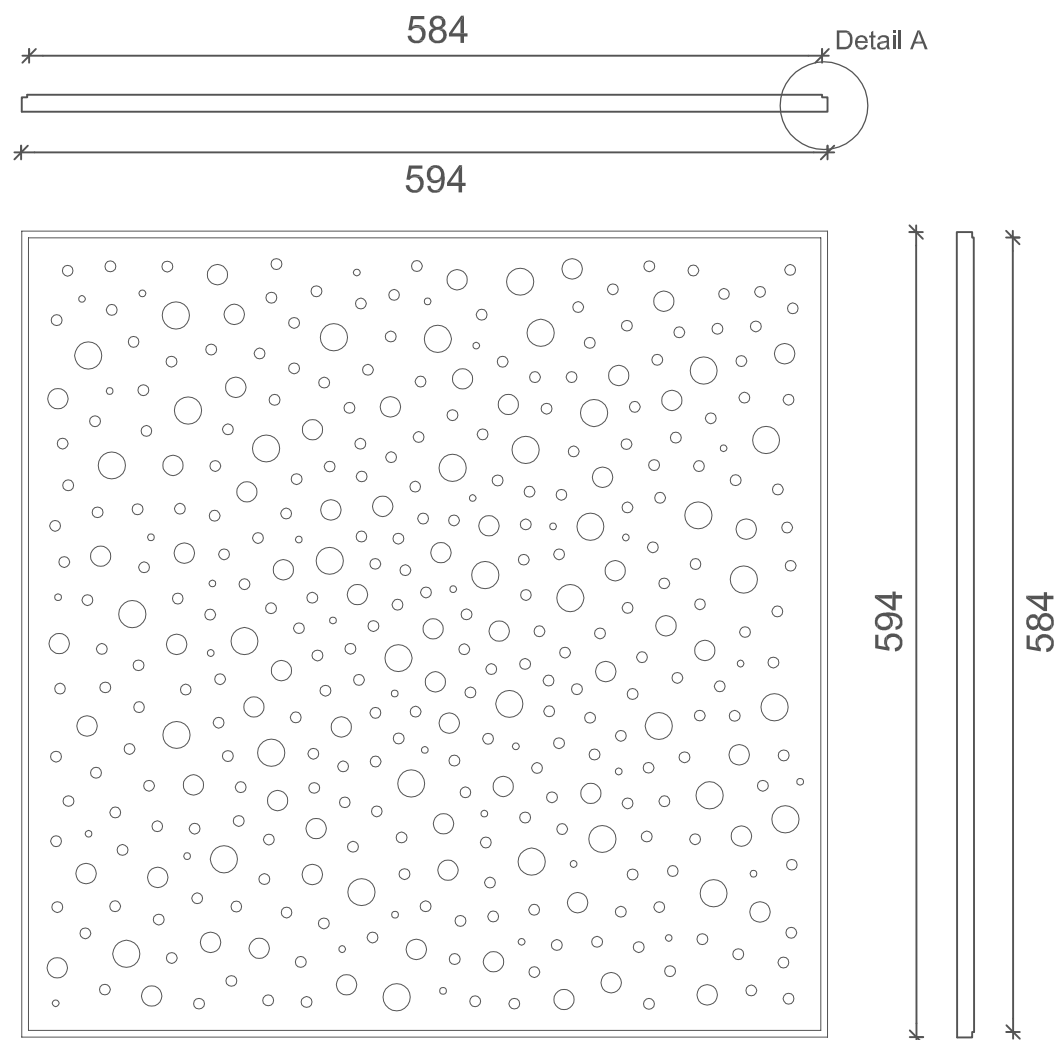

Detail A

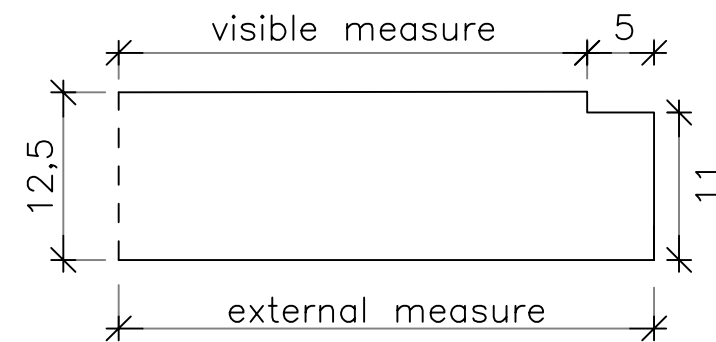

Perforation pattern:	Unity 8115I20
Perforation percentage:	10,8 %
Edge type:	Plaza A+
Grid:	S15
Module:	600 x 600 x 12,5mm
Visible measure (primary):	584 x 584mm
External measure (secondary):	594 x 594mm
Perforation picture:	553,6 x 553,6mm

Project: Plaza A+ S15, Module 600x600, Unity 8115I20	MDM no.: 469244
Subject:	Scale:
	Date: 2018-04-20
	Rev.:
	Sign.: NPJ
	Project no.:
Knauf Danoline A/S Kløvermarksvej 6, DK-9500 Hobro T: +45 9657 3000 F: +45 9657 3001 www.knaufdanoline.com - info@knaufdanoline.com	File:

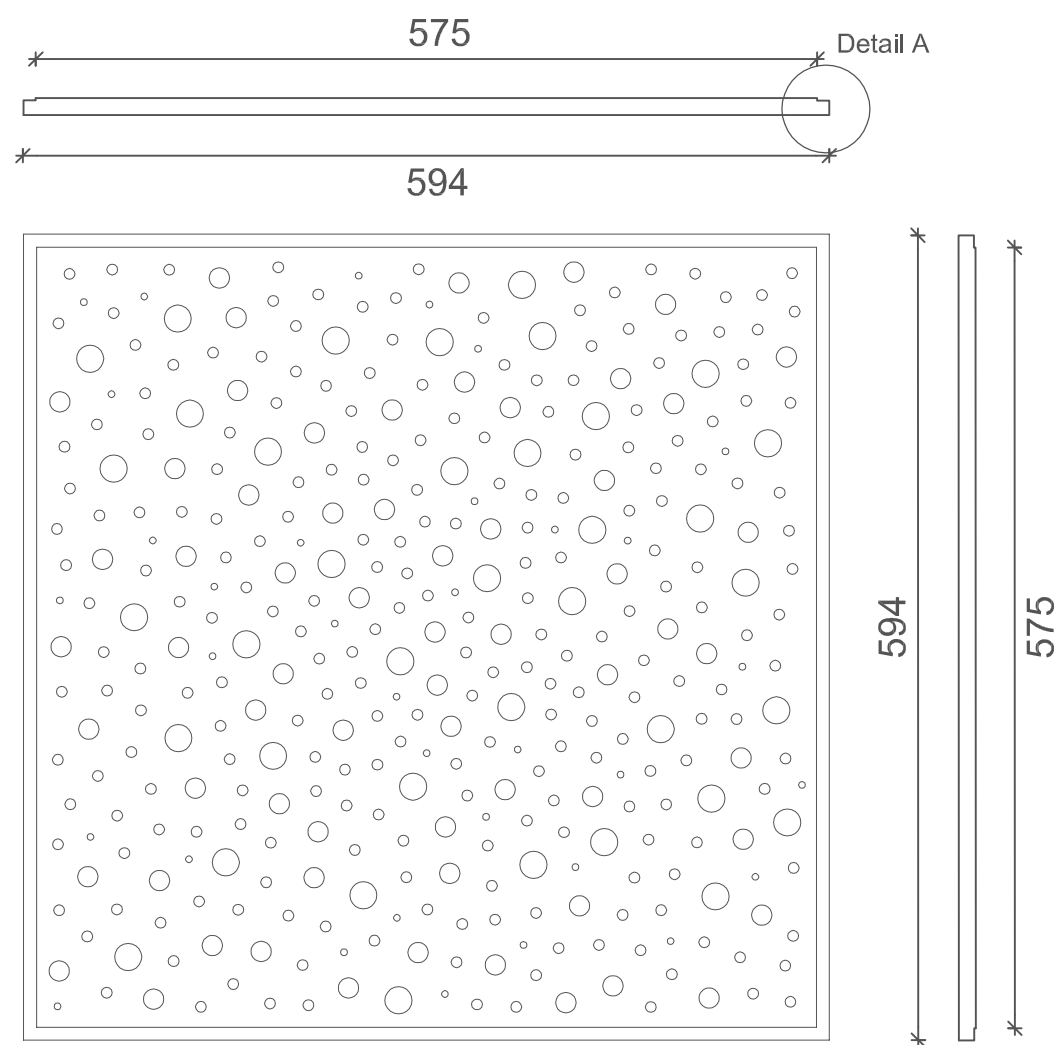

Detail A

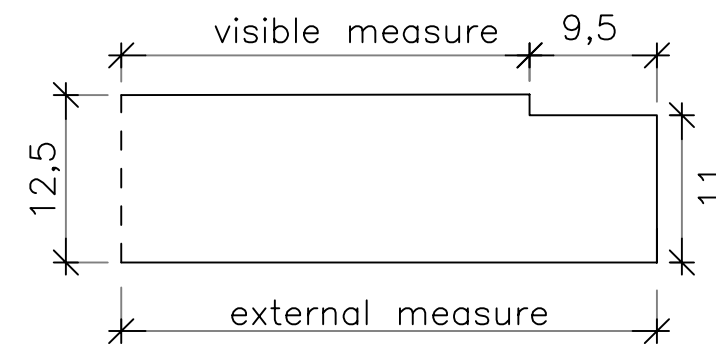

Perforation pattern:	Unity 8I15I20
Perforation percentage:	10,8 %
Edge type:	Plaza A+
Grid:	S24
Module:	600 x 600 x 12,5mm
Visible measure (primary):	575 x 575mm
External measure (secondary):	594 x 594mm
Perforation picture:	553,6 x 553,6mm

Project: Plaza A+ S24, Module 600x600, Unity 8I15I20	MDM no.: 473245
Subject:	
	Scale:
	Date: 2018-04-20
	Rev.:
	Sign.: NPJ
Knauf Danolne A/S Kløvermarksvej 6, DK-9500 Hobro T: +45 9657 3000 F: +45 9657 3001 www.knaufdanolne.com - Info@knaufdanolne.com	Project no.:
	File: